



 **SHEFFIELD 钢盾®**
工 业 级 工 具

杭州九堡总部

>> 公司简介
COMPANY
PROFILE



杭州巨星钢盾工具有限公司系国内五金工具行业上市企业杭州巨星科技股份有限公司（股票简称：巨星科技、股票代码：002444）的控股子公司，专业从事五金工具的研发、生产和销售。巨星科技是全球具有重要影响力的手工具产销企业，欧美众多工业用户的专业级工具供应商，在杭州经济技术开发区、杭州江干科技园、浙江海宁经济开发区有多个生产基地。

杭州巨星钢盾工具有限公司依托巨星科技资源优势，全力开拓国内市场，旗下自主品牌SHEFFIELD钢盾是服务于国内中高端市场的知名工具品牌，提供由产品供应到工具配套解决方案的全方位服务。

SHEFFIELD钢盾拥有强大的研发能力，每年有数百种专利产品和新产品上市，通过技术革新构建核心竞争力，引领行业发展。2011年，公司中心实验室顺利通过中国合格评定国家认可委员会（CNAS）的严格审查，公司品控能力成为行业标杆。SHEFFIELD钢盾各质量指标均达到或超过ANSI美国标准、DIN德国标准和中国国家标准，让用户尽享高品质产品带来的精彩体验。

SHEFFIELD钢盾始终致力于建立完善的产品线以及产品线的延伸，目前产品已涵盖机工类工具、汽保机修专用工具、电子电工类工具、工具包，箱，车等18大类，力求为机械制造、汽车维修保养、轨道交通、航空、石化、电力、煤矿等行业提供一站式购足的服务。

SHEFFIELD钢盾将以推动中国工具行业发展为己任，让五金工具的使用者作业更专业、更高效、更省心。

SHEFFIELD 在全球



SHEFFIELD 欧洲总部
负责欧洲地区的销售和服务



SHEFFIELD 美国总部
负责北美洲、南美洲地区的销售和服务



SHEFFIELD 中国总部
负责亚洲地区的销售和服务
杭州市江干科技园九环路35号
免费服务电话：**400-826-1929**

>> 公司背景 COMPANY BACKGROUND

上市公司旗下主力企业

杭州巨星钢盾工具有限公司的控股母公司巨星科技，于2010年7月在深圳证券交易所隆重上市，股票代码：002444。

行业标杆地位

巨星科技拥有丰富的产品系列和遍布全球的销售网络，手工具销售规模位居全球前列。享有2008中国自主创新TOP100（第57位）、全国企事业知识产权试点单位、浙江省专利示范企业、浙江省企业技术中心等殊荣。

与一流企业同伍

2011年1月，巨星科技的控股股东巨星控股集团有限公司成功收购了中国叉车行业的排头兵——浙江杭叉控股股份有限公司。
2015年7月，巨星科技并购全球知名的激光测量工具和测控系统研发的智能装备企业常州华达科捷光电仪器有限公司。

与国际知名品牌共发展

巨星科技旗下国际知名品牌

WORKPRO®
全球知名的工具品牌

Goldblatt
TOOLS
北美著名的百年工具品牌

PaceSetter
北美著名的家用五金工具品牌

SABERTOOTH
北美知名的手动工具品牌

>>研发能力
R&D
CAPABILITIES

SHEFFIELD钢盾拥有强大的研发能力，研发部门100多名工程师直接从事新产品的研发，年开发设计新产品400项左右。截至目前，拥有国内外各项专利638项，且以年均20多项的数量递增。



>> 行业先锋
INDUSTRY
PIONEER

“麻面沾塑”技术

1992年，研发了“麻面沾塑”技术，并使其国产化；同年，推出“双色沾塑”发明技术，至今仍被广泛使用

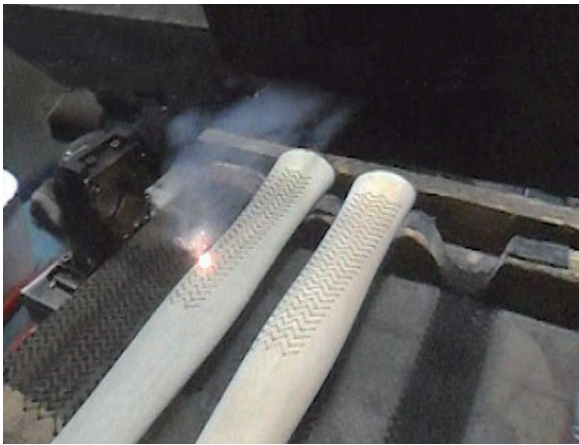

激光刻花技术

1997年4月，将激光刻花技术应用到锤子木柄上



炼出50、60铬镍钢

1999年5月，指导南通海门钢铁厂炼出铬镍钢，将其应用到工具上，使工具更加经久耐用



刀具刃口激光淬火技术

2004年，采用刀具刃口激光淬火技术，刃口加热时间短，硬度高，变形小

>> 生产能力
PRODUCTION
CAPACITY

SHEFFIELD钢盾在杭州经济技术开发区、杭州江干科技园、浙江海宁经济开发区有多个生产基地，生产能力行业领先，能最大限度地缩短供货周期，提高客户满足率。



∧ 数控车间



∧ 快速成型车间



∧ 智能仓储中心

>> 检测和实验中心
DETECHTION &
EXPERIMENTAL
CENTER

SHEFFIELD钢盾拥有一系列先进的检测和分析设备，上百人的品控工程师，是国内工具行业具有重要影响力的高水准综合性检测基地。2011年，公司中心实验室通过中国合格评定国家认可委员会（CNAS）的严格评审，并于2013年10月顺利通过扩项评审，公司品控能力成为行业标杆。

实验中心涵盖化学实验室、材料实验室、扭力实验室、拉力实验室、硬度实验室、电机实验室、电池实验室、高低温湿热实验室、包装运输实验室等。SHEFFIELD钢盾全系列产品在出厂前均经过严格质量检测，有效保证产品品质。

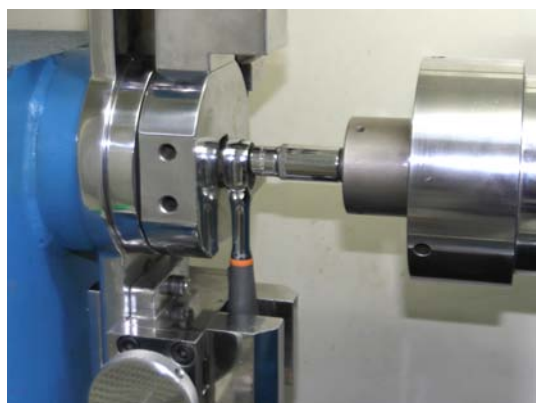

质检中心



实验中心

>> 定制化服务

CUSTOMIZED SERVICES

定制化服务是提供有效解决方案的关键，SHEFFIELD钢盾凭借在研发、生产、品控方面的优势，能为客户提供完善的定制化服务。目前，钢盾定制化产品已成功运用在电力、轨道交通、机械制造、煤矿等行业，解决了客户工具配套中的难题。



2018年 新品上市

双肩背包

S023019

tool bag

- ◆ 600D涤纶布
- ◆ 多口袋设计
- ◆ 结实耐磨



详见P32

多功能弯刀电缆剥刀

S036004

Multifunctional cable cutting knife

- ◆ 多功能设计，剥线范围8-28mm
- ◆ 高速钢刀口，锋利快速



详见P49

32件套6.3mm系列气动旋具头组套

S054002

32PC Color Bits Set



详见P86

5抽屉工具车

S025011

Tool Trolley

- ◆ 单层抽屉承重35kg, 整体可承重300kg
- ◆ 5抽屉滚珠滑轨



详见P38

19件套综合绝缘组套

S158024

19pc VDE Tools Set

- ◆ VDE绝缘认证



详见P55

无弹力橡胶锤

S088935

Dead Blow Hammer

- ◆ 进口NBR丁腈橡胶材质，耐高温，耐油，抗腐蚀
- ◆ 内置钢珠，有效防止回弹



详见P103

铝合金拉杆箱

S026002

Aluminum Toolbox Trolley

- ◆ 加厚全铝拉丝面板
- ◆ 加强黑色尼龙脚轮
- ◆ 内置伸缩拉杆，可承重40kg



详见P35

20件套12.5mm系列绝缘套筒组套

S158021

20pc 12.5mm series isolate sleeves set

- ◆ VDE绝缘认证



详见P55

2PC 24齿双金属锯条

S069134

2PC 24 gear double metal saw blade



详见P94

充磁及退磁器

S059100

Magnetizer/Demagnetizer

- ◆ 高强度环保ABS材质



详见P81

66件套新能源汽车维修工具车组套

S158023

66pc maintain tool set cabinet for new source vehicle

- ◆ VDE绝缘认证
- ◆ 专为新能源汽车维修设计



详见P54

10PC 24齿双金属锯条

S069135

Sleeve set for Audi series anti-theft screw



详见P94

5合1多功能尖嘴电钳

S035057

5-in-1 multifunctional nipper pliers

- ◆ 优质CR-V锻造
- ◆ 5合1功能，集剥线，剪切，夹持功能为一体
- ◆ 压接1-22AWG费绝缘端子
- ◆ 专利设计



详见P46

66件套新能源汽车维修工具箱组套

S158022

66pc maintain tool set box for new source vehicle

- ◆ VDE绝缘认证
- ◆ 专为新能源汽车维修设计



详见P54

1.5"榉木双夹铲刀

S112014

1.5" double blade beech



详见P118

轮纹深度尺 S117022
Tread Depth Gauge



详见P122

20T液压力机 S160053
Hydraulic Shop Press



详见P130

10.5"经济型半全托手套 S180022
Leather Working Gloves



详见P136

数显轮纹深度尺 S117023
Digital Tread Depth Gauge



详见P122

引擎吊机 S160051
Engine Crane



详见P130

KN95折叠式颗粒物防护口罩 S190001-S190002
Disposable Safety KN95 Dust Mask



详见P136

手持式数显充气表 S114013
Digital Inflator Gauge

- ◆ 内置高精度传感器，读数精准
- ◆ 测气、充气、排气，3合1功能
- ◆ 充气流量Max: 900ml/分钟



详见P122

子弹型PU防噪音耳塞(不带线) S180001
Bullet Shape Earplugs



详见P136

工业级内窥镜 S034005
Industrial Endoscope

- ◆ 360° 全视角影像
- ◆ 45万像素
- ◆ IP67级防水设计



详见P42

变速箱运送千斤顶 S160052
Transmission Jack



详见P130

圣诞树型硅胶防噪音耳塞(带线) S180003
4 Layers Christmas Tree Silicone Earplugs(With Code)



详见P136

气动扭力扳手 S016231-S016239
The Aerodynamic Torque Wrench



详见P132

分离式千斤顶套装 S160054
Hydraulic Portable Body Repair Kits



详见P130

14"斜指焊接手套 S180021
14" Leather Welding Gloves



详见P136

伸缩管钳 S104218
Pipe Wrench

- ◆ 整体精锻加工而成
- ◆ 套管式加力伸缩手柄，轻便省力
- ◆ 体积小、重量轻、扭矩大、强度高



详见P114

起重葫芦系列

Hoist Series



改良型转动齿轮，低合金钢精密加工，渗碳热处理工艺，齿轮硬度高，耐磨和防锈性能双提升



外罩采用特殊卷边工艺，强度更高，链条滚动更顺滑。改良型传动系统，传动效率更高，运转更灵活



三轴承结构取代钢套干磨（2T以上），传动效率更高，运转更灵活。特殊设计的三角花键长轴结构，中心轴能全部取，便于清洁，彻底解决卡链问题。



上、下吊钩采用优质合金锻造成型，通过1.5倍超载试验，确保安全



对称式双棘爪制动系统，相比单棘爪制动，安全系数更高



80级起重链条，达到国际高标准

详见P128

塑胶风枪

S117011

Air Blow Gun



详见P124

塑胶风枪

S117012

Air Blow Gun



详见P124

铝合金风枪

S117020

Air Duster



详见P124

10mm系列12角薄壁火花塞套筒

S114015

10mm Drive 12PT Spark Plug Socket



详见P121

12.5mm系列套筒链式滤清器扳手

S113044

12.5mm Socket Chain Filter Wrench Series



详见P118

外热式电烙铁

S038010-S038013

Electric Iron



详见P51

CONTENTS 目录

	机工类工具 组套工具、套筒及驱动配件、旋具套筒、扳手及快扳、敲击扳手、扭力扳手	1-30
	工具包、箱、车 工具包套装、工具包、塑料工具箱、铁工具箱、工具车、铝合金工具箱	31-38
	电子电工类工具 套装类、手电筒、万用表、测电类、镊子、电工电子钳、电缆剪、电工剪刀、精密螺丝批、电烙铁及附件	39-52
	VDE绝缘类工具 螺丝批、钳类、扳手、套筒、电工刀、锯架、线夹及镊子	53-63
	液压类工具 液压压线钳、液压断线钳、液压拉马	64-65
	夹持类工具 台虎钳、F夹、普通钳、挡圈钳、大力钳	66-73
	紧固类工具 内六角扳手、拉铆枪、硅胶枪、螺丝刀系列、旋具头	74-88
	切割类工具 断线钳、各式割刀、剪刀、锯类	89-94
	测量类工具 塞尺、卷尺、水平尺、不锈钢尺、游标卡尺	95-98
	敲击类工具 冲类、凿类、冲凿类套装、撬棒、斧锤类	99-103
	表面修整类工具 金刚石锉、修边器、钳工锉	104-107
	刃具类工具 丝锥板牙及组套、绞手、直柄麻花钻及套装	108-111
	管道类工具 切管类、弯管器、管钳	112-114
	汽保机修专用工具 组套工具、润滑工具、引擎维修、底盘/传动维修、制冷维修工具、轮胎维护、车身维修、通用工具	115-125
	起重类工具 立式千斤顶、卧式千斤顶	126-128
	小型汽保设备 引擎吊机、压机、立式运送顶、分离式千斤顶	129-130
	气动工具 气动扳手、气动套筒及配件	131-134
	个人防护用品 耳塞、手套、口罩	135-136



SHEFFIELD



机工类工具 **MECHANICS TOOLS**

组套工具、套筒及驱动配件、旋具套筒、扳手及快扳、敲击扳手、扭力扳手
Tool Set, Socket, Bit Socket, Wrench, Slogging Wrench, Torque Wrench

组套系列 Tool Set



铭牌采用铝合金材质, 高光切削工艺加工, 表面光滑、平整, 特有反光警示功能

Logo plate using aluminum alloy, specular cutting craft, smooth surface treatment, with light reflection function



采用优质锌合金材质搭扣, 面雾化处理, 耐用、美观、不易折断

The hasp adopting qualified zinc alloy, atomization surface treatment, ensuring durable, fine shape, anti-break



专利快速结构设计, 金属销钉连接, 可轻松拆卸、更换、组合并确保使用寿命, 坚固结实、不易断裂

Patented quick structure design, connected with metallic pin, easy to assembly, disassembly long service life, durability, anti-break



耐油TPR软性手柄, 人体工程学设计, 握持舒适

Ergonomic design, oil-resistant soft grip handle for comfort

120件综合性组套

120 Pc Tool Set

- 采用优质铬钒钢
- 表面镀铬, 镜面抛光处理
- Chrome-Vanadium steel
- Chrome plated, mirror polished

CR-V



Item no.

S010001



1

- 10件 6.3mm系列公制六角标准套筒: 4, 5, 6, 7, 8, 9, 10, 11, 12, 13mm
- 4件 6.3mm系列公制六角长套筒: 8, 9, 10, 12mm
- 11件 10mm系列公制六角标准套筒: 9, 10, 11, 12, 13, 14, 15, 16, 17, 18, 19mm
- 4件 10mm系列公制六角长套筒: 13, 14, 15, 17mm
- 7件 12.5mm系列公制六角标准套筒: 20, 21, 22, 24, 27, 30, 32mm
- 8件 10mm系列花型套筒: E8, E10, E11, E12, E14, E16, E18, E20
- 2件 10mm系列公制六角火花塞套筒: 16, 21mm
- 6件 10mm系列花型套筒: T20, T30, T40, T45, T50, T55
- 4件 10mm系列公制六角套筒: 3, 4, 5, 6mm
- 2件 10mm系列十字型套筒: PH1, PH2
- 2件 10mm系列米字型套筒: PZ1, PZ2
- 2件 10mm系列公制一字型套筒: 5.5, 6.5mm
- 1件 6.3mm系列起子变头
- 1件 6.3mm系列旋柄
- 1件 6.3mm系列接杆: 2"
- 2件 10mm系列接杆: 3", 6"
- 2件 12.5mm系列接杆: 5", 10"
- 1件 6.3mm系列万向接头 34mm
- 1件 10mm系列万向接头 54.2mm
- 1件 12.5mm系列万向接头 68.5mm
- 1件 10mm系列大小接头: 10mmx6.3mm
- 1件 10mm系列大小接头: 10mmx12.5mm(带孔)
- 1件 12.5mm系列大小接头: 12.5mmx10mm
- 10件 公制精抛光两用长柄扳手: 8, 9, 10, 11, 12, 13, 14, 17, 18, 19mm
- 9件 9件套公制加长内六角扳手: 1.5, 2, 2.5, 3, 4, 5, 6, 8, 10mm
- 1件 12.5mm系列L型套筒扳杆
- 1件 12.5mm系列起子变头 5/16"
- 1件 6.3mm系列梨型头快速脱落胶柄棘轮扳手
- 1件 10mm系列梨型头快速脱落胶柄棘轮扳手
- 1件 12.5mm系列梨型头快速脱落胶柄棘轮扳手
- 7件 6.3mm系列25mm长中孔花型套筒: T10, T15, T20, T25, T27, T30, T40
- 2件 8mm系列30mm长六角旋具头: 12, 14mm
- 3件 8mm系列30mm长一字旋具头: 8, 10, 12mm
- 2件 8mm系列30mm长十字旋具头: PH3, PH4
- 3件 8mm系列30mm长花形旋具头: T45, T50, T55
- 4件 12.5mm系列公制六角风动套筒: 17, 19, 21, 23mm

150件套综合性组套

150 Pc Tool Set

- 采用优质铬钒钢
- 表面镀铬, 镜面抛光处理
- Chrome-Vanadium steel
- Chrome plated, mirror polished

CR-V



Item no.

S010002



1

- 10件 6.3mm系列公制六角套筒: 4, 5, 6, 7, 8, 9, 10, 11, 12, 13mm
- 6件 6.3mm系列六角公制长套筒: 4, 5, 6, 7, 8, 9mm
- 3件 10mm系列十字型套筒: PH1, PH2, PH3
- 6件 10mm系列六角公制长套筒: 10, 11, 12, 13, 14, 15mm
- 2件 10mm系列接杆: 3", 6"
- 2件 10mm系列六角火花塞套筒: 16, 21mm
- 6件 12.5mm系列六角公制长套筒: 10, 12, 13, 14, 17, 19mm
- 8件 10mm系列花型套筒: E8, E10, E11, E12, E14, E16, E18, E20
- 11件 10mm系列六角公制套筒: 9, 10, 11, 12, 13, 14, 15, 16, 17, 18, 19mm
- 3件 10mm系列一字型套筒: 4.0, 5.5, 6.5mm
- 4件 12.5mm系列六角公制风动套筒: 17, 19, 21, 23mm
- 4件 6.3mm系列25mm长十字型套筒: PH0, PH1, PH2, PH3
- 6件 6.3mm系列25mm长一字型套筒: 3, 4, 5, 5.5, 6, 6.5mm
- 3件 6.3mm系列25mm长米字型套筒: PZ1, PZ2, PZ3
- 8件 6.3mm系列25mm长六角型套筒: 2, 2.5, 3, 4, 5, 6, 7, 8mm
- 7件 6.3mm系列25mm长中孔花型套筒: T10, T15, T20, T25, T27, T30, T40
- 7件 12.5mm系列12角公制套筒: 20, 21, 22, 24, 27, 30, 32mm
- 2件 12.5mm系列转向接杆: 5", 10"
- 3件 10mm系列花型套筒: T20, T30, T40
- 6件 10mm系列六角型套筒: 3, 4, 5, 6, 8, 10mm
- 3件 10mm系列米字型套筒: PZ1, PZ2, PZ3
- 12件 公制全抛光两用扳手: 8, 9, 10, 11, 12, 13, 14, 15, 16, 17, 18, 19mm
- 3件 公制全抛光双梅花棘轮扳手: 8x10, 12x13, 17x19mm
- 9件 9件套公制加长球头内六角扳手: 1.5, 2, 2.5, 3, 4, 5, 6, 8, 10mm
- 1件 6.3mm系列专业快速脱落棘轮扳手
- 1件 6.3mm系列接杆: 4"
- 1件 6.3mm系列旋柄
- 1件 6.3mm系列万向接头
- 1件 6.3mm系列旋具头接头
- 1件 6.3mm系列大小接头: 6.3mmx10mm
- 1件 10mm系列大小接头: 10mmx6.3mm
- 1件 10mm系列三通接头: 10mmx12.5mm(带孔)
- 1件 12.5mm系列大小接头: 12.5mmx10mm
- 1件 10mm系列专业快速脱落棘轮扳手
- 1件 10mm系列万向接头
- 1件 10mm系列T型滑杆 200mm
- 1件 12.5mm系列专业快速脱落棘轮扳手
- 1件 12.5mm系列万向接头
- 1件 12.5mm系列L型套筒扳杆
- 1件 带灯铝合金磁性伸缩式捡拾器

86件套综合性组套

86 Pc Tool Set

- 采用优质铬钒钢
- 表面镀铬, 镜面抛光处理
- Chrome-Vanadium steel
- Chrome plated, mirror polished

CR-V



Item no.

S010086



1

- 13件 6.3mm系列公制六角标准套筒:
4, 4.5, 5, 5.5, 6, 7, 8, 9, 10, 11, 12, 13, 14mm
- 8件 6.3mm系列公制六角长套筒:
6, 7, 8, 9, 10, 11, 12, 13mm
- 1件 12.5mm系列专业快速脱落胶柄棘轮扳手
- 1件 6.3mm系列专业快速脱落胶柄棘轮扳手
- 4件 6.3mm系列接杆: 2", 4"; 6.3mm系列T型滑杆;
6.3mm系列旋柄;
- 2件 6.3mm系列万向接头; 10mm系列三用接头
- 14件 12.5mm系列公制六角标准套筒: 13, 15, 16, 17,
18, 19, 20, 21, 22, 23, 24, 27, 30, 32mm
- 5件 12.5mm系列公制六角长套筒:
14, 16, 17, 19, 21mm
- 2件 12.5mm系列接杆: 5", 10"
- 1件 12.5mm系列万向接头
- 3件 12.5mm系列旋具头接头8mm;
12.5mm火花塞套筒: 16, 21mm
- 17件 6.3mm系列花型旋具套筒:
T8, T10, T15, T20, T25, T30
6.3mm系列六角旋具套筒: 3, 4, 5, 6mm
6.3mm系列十字型旋具套筒: PH1, PH1, PH2, PH2
6.3mm系列一字型旋具套筒: 4, 5.5, 6.5mm
- 15件 8mm系列一字型旋具头: 8, 10, 12mm
8mm系列十字型旋具头: PH3, PH4
8mm系列米字型旋具头: PZ3, PZ4
8mm系列花型旋具头: T40, T45, T50, T55
8mm系列公制六角旋具头: 8, 10, 12, 14mm

79件套综合性组套

79 Pc Tool Set

- 采用优质铬钒钢
- 表面镀铬, 镜面抛光处理
- Chrome-Vanadium steel
- Chrome plated, mirror polished

CR-V



Item no.

S010079



1

- 11件 公制精抛光两用长扳手:
8, 10, 11, 12, 13, 14, 15, 16, 17, 18, 19mm
- 9件 6.3mm系列公制六角标准套筒:
5.5, 7, 8, 9, 10, 11, 12, 13, 14mm
- 12件 12.5mm系列公制六角标准套筒:
8, 10, 12, 13, 14, 15, 16, 17, 18, 19, 22, 24mm
- 18件 6.3mm系列花型旋具套筒:
T8, T10, T15, T20, T25, T30, T40
6.3mm系列六角旋具套筒: 3, 4, 5, 6, 8, 10mm
6.3mm系列十字型旋具套筒: PH1, PH2
6.3mm系列一字型旋具套筒: 4, 5.5, 6.5mm
- 15件 8mm系列30mm长一字型旋具头: 8, 10, 12mm
8mm系列30mm长十字型旋具头: PH3, PH4
8mm系列30mm长米字型旋具头: PZ3, PZ4
8mm系列30mm长花型旋具头:
T40, T45, T50, T55
8mm系列30mm长公制六角旋具头:
H8, H10, H12, H14
- 1件 6.3mm系列专业快速脱落胶柄棘轮扳手
- 1件 12.5mm系列专业快速脱落胶柄棘轮扳手
- 4件 6.3mm系列旋柄; 10mm系列三用接头;
12.5mm系列接杆: 5", 10"
- 3件 6.3mm系列接杆: 2", 4"; 6.3mm系列万向接头
- 2件 12.5mm系列万向接头;
12.5mm系列旋具头接头8mm
- 3件 12.5mm火花塞套筒: 16, 21mm;
6.3mm系列T型滑杆

42件套综合性组套

42 Pc Tool Set

- 采用优质铬钒钢
- 表面镀铬, 镜面抛光处理
- Chrome-Vanadium steel
- Chrome plated, mirror polished

CR-V



Item no.

S010042



1

- 20件 12.5mm系列公制六角标准套筒:
8, 9, 10, 11, 12, 13, 14, 15, 16, 17, 18, 19, 20,
21, 22, 23, 24, 27, 30, 32mm
- 14件 公制精抛光两用长扳手: 6, 7, 8, 9, 10, 11, 12,
13, 14, 15, 16, 17, 18, 19mm
- 2件 12.5mm系列公制六角火花塞套筒: 16mm, 21mm
- 2件 12.5mm系列接杆: 5", 10"
- 1件 12.5mm系列万向接头
- 1件 12.5mm系列大小接头
- 1件 12.5mm系列F型套筒扳杆
- 1件 12.5mm系列专业快速脱落胶柄棘轮扳手

64件套快修店组套

64 Pc Tool Set

- 采用优质铬钒钢
- 表面镀铬, 镜面抛光处理
- Chrome-Vanadium steel
- Chrome plated, mirror polished

CR-V



Item no.

S010064



1

- 15件 10mm系列公制六角标准套筒: 7, 8, 10, 11, 12,
13, 14, 15, 16, 17, 18, 19, 21, 22, 24mm
- 3件 6.3mm系列旋柄, 6.3mm系列旋具接头, 6.3mm
系列大小接头6.3x10mm
- 2件 10mm系列火花塞套筒16, 21mm
- 4件 10mm系列万向接头, 10mm系列大小接头
10X6.3mm, 10mm系列接杆3", 10"
- 1件 10mm系列梨型头快速脱落胶柄棘轮扳手
- 11件 欧式凹筋两用扳手: 8, 10, 12,
13, 14, 15, 16, 17, 18, 19, 22mm
- 2件 双色柄6"尖嘴钳, 8"鲤鱼钳
- 9件 9件套公制加长内六角扳手1.5, 2, 2.5, 3, 4, 5, 6,
8, 10mm
- 2件 6.3mm系列25mm长十字旋具头: PH1, PH3
- 3件 6.3mm系列25mm长一字旋具头: 4, 5, 6.5mm
- 6件 6.3mm系列25mm长花型旋具头:
T10, T15, T20, T25, T30, T40
- 4件 6.3mm系列25mm长六角旋具头: H3, H4, H5, H6
- 2件 一字通体螺丝刀6X100mm,
十字通体螺丝刀PH2X100mm

61件套机械维修组套
61 Pc Tool Set

- 采用优质铬钒钢
- 表面镀铬, 镜面抛光处理
- Chrome-Vanadium steel
- Chrome plated, mirror polished

CR-V

Item no.

S010061

1

- 14件 10mm系列公制六角标准套筒: 6, 7, 8, 9, 10, 11, 12, 13, 14, 15, 16, 17, 18, 19mm
- 13件 欧式凹筋两用扳手: 8, 10, 11, 12, 13, 14, 15, 16, 18, 19, 21, 22, 24mm
- 5件 卡簧钳
- 1件 8"活扳手
- 3件 双色柄一字螺丝刀6x40, 3x75, 5x100mm
- 4件 双色柄十字螺丝刀十字: PH2x45, PH0x75, PH1x100, PH2x150mm
- 1件 10mm系列梨型头快速脱落胶柄棘轮扳手
- 1件 10mm系列万向接头
- 9件 公制特长球头内六角扳手: 1.5, 2, 2.5, 3, 4, 5, 6, 8, 10mm
- 1件 公制精抛光棘开两用长快扳17mm
- 2件 双色柄8"钢丝钳, 双色柄6"尖嘴钳
- 3件 3m卷尺, 23件套塞尺, 150mm不锈钢直尺
- 1件 纤维柄圆头锤16OZ
- 1件 26"磁性伸缩式捡拾器
- 1件 18mm塑柄金属护套美工刀
- 1件 高强度铝合金手电筒(2节5号电池) 9LED

16件套基本维修组套
16 Pc Tool Set

- 采用优质铬钒钢
- 表面镀铬, 镜面抛光处理
- Chrome-Vanadium steel
- Chrome plated, mirror polished

CR-V

Item no.

S022005

1

- 1件 塑料零件盒(带零件)
- 4件 高强度铝合金手电筒9LED, 尖头镊子, 测电螺丝批150mm, 电工绝缘胶布
- 3件 双色柄钢丝钳6", 双色柄尖嘴钳6", 鲤鱼钳6"
- 2件 双色柄一字螺丝批5mmx100mm, 双色柄十字头螺丝批PH1x100mm
- 1件 18mm塑柄金属护套美工刀
- 1件 6-1/2"双色不锈钢剪刀
- 2件 袖珍钢锯8-3/4", 卷尺3m
- 1件 硬木柄羊角锤8OZ
- 1件 8"活扳手

26件套12.5mm系列公制12角组套
26 Pc Tool Set

- 采用优质铬钒钢
- 表面镀铬, 镜面抛光处理
- Chrome-Vanadium steel
- Chrome plated, mirror polished

CR-V

Item no.

S010026

1

- 20件 12.5mm系列公制12角套筒: 10, 11, 12, 13, 14, 15, 16, 17, 18, 19, 20, 21, 22, 23, 24, 25, 26, 27, 30, 32mm
- 2件 12.5mm系列接杆: 5", 10"
- 1件 12.5mm系列万向接头
- 1件 12.5mm系列公制六角火花塞套筒: 21mm
- 1件 12.5mm系列T型滑杆
- 1件 12.5mm系列专业快速脱落胶柄棘轮扳手

28件套综合性组套
28 Pc Tool Set

- 采用优质铬钒钢
- 表面镀铬, 镜面抛光处理
- Chrome-Vanadium steel
- Chrome plated, mirror polished

CR-V

Item no.

S010028

1

- 18件 12.5mm系列公制六角标准套筒: 10, 11, 12, 13, 14, 15, 16, 17, 18, 19, 20, 21, 22, 23, 24, 27, 30, 32mm
- 2件 12.5mm系列接杆: 5", 10"
- 2件 12.5mm系列万向接头; 12.5mm系列大小接头
- 1件 12.5mm系列专业快速脱落胶柄棘轮扳手
- 1件 8"活扳手
- 1件 6"美式尖嘴钳
- 3件 双色柄螺丝刀: 3x75mm
双色柄螺丝刀: 5x100mm
双色柄螺丝刀: #1x100mm

58件套12.5mm系列公制组套
58 Pc Tool Set

- 采用优质铬钒钢
- 表面镀铬, 镜面抛光处理
- Chrome-Vanadium steel
- Chrome plated, mirror polished

CR-V

Item no.

S010058

1

- 17件 12.5mm系列公制六角标准套筒: 10, 11, 12, 13, 14, 15, 16, 17, 18, 19, 20, 21, 22, 23, 24, 30, 32mm
- 8件 12.5mm系列公制六角标准长套筒: 10, 12, 13, 14, 15, 16, 17, 19mm
- 1件 12.5mm系列专业快速脱落胶柄棘轮扳手
- 4件 12.5mm系列5", 10"接杆;
- 3件 12.5mm系列万向接头; 10mm系列三用接头
- 3件 12.5mm系列起子变换头; 12.5mm系列公制火花塞六角套筒16, 21mm
- 25件 8mm系列一字型旋具头: 8, 10, 12mm
8mm系列十字型旋具头: PH1, PH2, PH3, PH4
8mm系列米字型旋具头: PZ1, PZ2, PZ3, PZ4
8mm系列花型旋具头: T20, T25, T30, T40, T45, T50, T55
8mm系列六角旋具头: 4, 5, 6, 8, 10, 12, 14mm

25件套12.5mm系列英制套筒组套
25Pc Tool Set

- 采用优质铬钒钢
- 表面镀铬, 镜面抛光处理
- Chrome-Vanadium steel
- Chrome plated, mirror polished

CR-V

Item no.

S020001

1

- 19件 12.5mm系列英制12角标准套筒: 1/4", 5/16", 3/8", 7/16", 1/2", 9/16", 19/32", 5/8", 11/16", 3/4", 25/32", 13/16", 7/8", 15/16", 1", 1-1/16", 1-1/8", 1-3/16", 1-1/4"
- 1件 12.5mm系列公制六角火花塞套筒: 21mm
- 1件 12.5mm系列梨型头快速脱落胶柄棘轮扳手
- 1件 12.5mm系列万向接头
- 1件 12.5mm系列T型滑杆
- 2件 12.5mm系列接杆5", 10"

25件套12.5mm系列综合组套

25Pc Tool Set

- 采用优质铬钒钢 • Chrome-Vanadium steel
- 表面镀铬, 镜面抛光处理 • Chrome plated, mirror polished

CR-V



Item no.	
S010025	1

- 12件 12.5mm系列公制12角标准套筒: 10, 11, 12, 13, 14, 15, 16, 17, 18, 19, 22, 24mm
- 3件 12.5mm系列公制六角长套筒: 13, 17, 19mm
- 1件 12.5mm系列公制六角火花塞套筒: 16mm
- 4件 12.5mm系列梨型头快速脱落胶柄棘轮扳手
12.5mm系列万向接头
10mm系列三用接头10mmx12.5mm (带孔)
12.5mm系列接杆10"
- 5件 全抛光两用扳手: 10, 11, 12, 13, 14mm

32件套12.5mm系列公制组套

32 Pc Tool Set

- 采用优质铬钒钢 • Chrome-Vanadium steel
- 表面镀铬, 镜面抛光处理 • Chrome plated, mirror polished

CR-V



Item no.	
S010032	1

- 21件 12.5mm系列公制六角标准套筒: 8, 9, 10, 11, 12, 13, 14, 15, 16, 17, 18, 19, 20, 21, 22, 23, 24, 27, 30, 32, 34mm
- 5件 12.5mm系列公制12角标准套筒: 10, 12, 14, 17, 19mm
- 1件 12.5mm系列专业快速脱落胶柄棘轮扳手
- 2件 12.5mm系列接杆: 5", 10"
- 1件 12.5mm系列T型滑杆
- 1件 12.5mm系列弓型杆
- 1件 12.5mm系列万向接头

58件套10mm系列公制组套

58 Pc Tool Set

- 采用优质铬钒钢 • Chrome-Vanadium steel
- 表面镀铬, 镜面抛光处理 • Chrome plated, mirror polished

CR-V



Item no.	
S010003	1

- 17件 10mm系列公制六角标准套筒: 7, 8, 9, 10, 11, 12, 13, 14, 15, 16, 17, 18, 19, 20, 21, 22, 24mm
- 9件 10mm系列公制六角长套筒: 8, 10, 11, 12, 13, 14, 15, 17, 19mm
- 2件 10mm系列公制六角火花塞套筒: 16, 21mm
- 5件 10mm系列梨型头快速脱落胶柄棘轮扳手
10mm系列万向接头
10mm系列三用接头10mmx12.5mm (带孔)
10mm系列接杆3"
10mm系列接杆10"
- 6件 10mm系列十字型旋具套筒: PH1x 2, PH2x2, PH3x2
- 3件 10mm系列公制一字型旋具套筒: 5.5, 6.5, 8mm
- 9件 10mm系列花型旋具套筒: T10, T15, T20, T25, T30, T40, T45, T50, T55
- 7件 10mm系列公制六角旋具套筒: H3, H4, H5, H6, H7, H8, H10

24件套12.5mm系列公制组套

24 Pc Tool Set

- 采用优质铬钒钢 • Chrome-Vanadium steel
- 表面镀铬, 镜面抛光处理 • Chrome plated, mirror polished

CR-V



Item no.	
S010024	1

- 18件 12.5mm系列公制六角标准套筒: 10, 11, 12, 13, 14, 15, 16, 17, 18, 19, 20, 21, 22, 23, 24, 27, 30, 32mm
- 3件 12.5mm系列接杆: 5", 10"; 12.5mm系列万向接头
- 2件 12.5mm系列大小接头; 12.5mm系列F型套筒扳杆
- 1件 12.5mm系列专业快速脱落胶柄棘轮扳手

20件套12.5mm系列公制组套

20 Pc Tool Set

- 采用优质铬钒钢 • Chrome-Vanadium steel
- 表面镀铬, 镜面抛光处理 • Chrome plated, mirror polished

CR-V



Item no.	
S010020	1

- 12件 12.5mm系列公制六角标准套筒: 10, 11, 12, 13, 14, 15, 16, 17, 18, 19, 22, 24mm
- 3件 12.5mm系列公制六角长套筒: 13, 17, 19mm
- 1件 12.5mm系列专业快速脱落胶柄棘轮扳手
- 3件 12.5mm系列接杆: 10"; 12.5mm系列万向接头; 10mm系列三用接头
- 1件 12.5mm系列公制六角火花塞套筒: 16mm

31件套10mm系列公制组套

31 Pc Tool Set

- 采用优质铬钒钢 • Chrome-Vanadium steel
- 表面镀铬, 镜面抛光处理 • Chrome plated, mirror polished

CR-V



Item no.	
S010031	1

- 15件 10mm系列公制六角标准套筒: 8, 9, 10, 11, 12, 13, 14, 15, 16, 17, 18, 19, 20, 21, 22mm
- 12件 10mm系列公制六角长套筒: 8, 9, 10, 11, 12, 13, 14, 15, 17, 19, 20, 22mm
- 2件 10mm系列接杆: 3", 6"
- 1件 10mm系列万向接头
- 1件 10mm系列专业快速脱落胶柄棘轮扳手

38件套6.3mm系列公制组套

38 Pc Tool Set

- 采用优质铬钒钢
- 表面镀铬, 镜面抛光处理
- Chrome-Vanadium steel
- Chrome plated, mirror polished

CR-V



Item no.	
S010038	1

- 13件 6.3mm系列公制六角标准套筒: 4, 4.5, 5, 5.5, 6, 7, 8, 9, 10, 11, 12, 13, 14mm
- 19件 6.3mm系列花型旋具套筒: T08, T10, T15, T20, T25, T30, T40
6.3mm系列六角旋具套筒: H3, H4, H5, H6, H7, H8, H10
6.3mm一字型旋具套筒: 4, 5.5, 6.5
6.3mm十字型旋具套筒: PH1, PH2
- 1件 6.3mm系列专业快速脱落胶柄棘轮扳手
- 2件 6.3mm系列接杆: 2", 4";
- 1件 6.3mm系列T型滑杆
- 1件 6.3mm系列旋柄
- 1件 6.3mm系列万向接头

25件套6.3mm系列公制组套

25 Pc Tool Set

- 采用优质铬钒钢
- 表面镀铬, 镜面抛光处理
- Chrome-Vanadium steel
- Chrome plated, mirror polished

CR-V



Item no.	
S010004	1

- 13件 6.3mm系列公制六角标准套筒: 4, 4.5, 5, 5.5, 6, 7, 8, 9, 10, 11, 12, 13, 14mm
- 6件 6.3mm系列公制六角长套筒: 7, 8, 10, 11, 12, 13mm
- 2件 6.3mm系列接杆2", 4"
- 1件 6.3mm系列T型滑杆
- 1件 6.3mm系列梨型头快速脱落胶柄棘轮扳手
- 1件 6.3mm系列万向接头
- 1件 6.3mm系列旋柄

64件套6.3mm系列套筒组合

64 Pc Tool Set

- 采用优质铬钒钢
- 表面镀铬, 镜面抛光处理
- Chrome-Vanadium steel
- Chrome plated, mirror polished

CR-V

可配合钢盾工具车使用



Item no.	
S025021	1

- 13件 6.3mm系列公制六角标准套筒: 4, 4.5, 5, 5.5, 6, 7, 8, 9, 10, 11, 12, 13, 14mm
- 10件 6.3mm系列公制六角长套筒: 4, 5, 6, 7, 8, 9, 10, 11, 12, 13mm
- 2件 6.3mm系列接杆: 2", 4"
- 5件 6.3mm系列梨型头快速脱落胶柄棘轮扳手
6.3mm系列万向接头 6.3mm系列旋柄
6.3mm系列T型滑杆 6.3mm系列起子变换头
- 2件 6.3mm系列十字型旋具套筒: PH1, PH2
- 3件 6.3mm系列公制一字型旋具套筒: 4, 5.5, 6.5mm
- 8件 6.3mm系列花型旋具套筒: T8, T10, T15, T20, T25, T27, T30, T40
- 7件 6.3mm系列公制六角旋具套筒: H3, H4, H5, H6, H7, H8, H10
- 4件 6.3mm系列一字旋具头: 3, 4, 5, 6mm
- 4件 6.3mm系列十字旋具头: PH0, PH1, PH2, PH3
- 3件 6.3mm系列六角旋具头: H3, H4, H5
- 3件 6.3mm系列花型旋具头: T15, T20, T25

35件套6.3mm系列公制组套

35 Pc Tool Set

- 采用优质铬钒钢
- 表面镀铬, 镜面抛光处理
- Chrome-Vanadium steel
- Chrome plated, mirror polished

CR-V



Item no.	
S010035	1

- 13件 6.3mm系列公制六角标准套筒: 4, 4.5, 5, 5.5, 6, 7, 8, 9, 10, 11, 12, 13, 14mm
- 15件 6.3mm系列花型旋具头: T10, T15, T20, T25, T30, T40
6.3mm系列六角旋具头: 3, 4, 5, 6mm
6.3mm十字型旋具头: PH1, PH2
6.3mm一字型旋具头: 4, 5.5, 6.5mm
- 1件 6.3mm系列专业快速脱落胶柄棘轮扳手
- 2件 6.3mm系列接杆: 2", 4"
- 1件 6.3mm系列T型滑杆
- 1件 6.3mm系列旋柄
- 1件 6.3mm系列万向接头
- 1件 6.3mm系列起子变换头

15件套19mm系列公制组套

15 Pc Tool Set

- 采用优质铬钼钢
- 表面镀铬, 镜面抛光处理
- Chrome-Molybdenum steel
- Chrome plated, mirror polished

CR-MO



Item no.	
S010015	1

- 10件 19mm系列公制12角标准套筒: 30, 32, 34, 36, 38, 41, 46, 50, 55, 60mm
- 3件 19mm系列棘轮扳手; 19mm系列T型滑杆; 19mm系列万向接头
- 2件 19mm系列接杆: 4", 8"

31件套10mm系列套筒组合

31Pc Tool Set

- 采用优质铬钒钢
- 表面镀铬, 镜面抛光处理
- Chrome-Vanadium steel
- Chrome plated, mirror polished

CR-V

可配合钢盾工具车使用



Item no.	
S025022	1

- 16件 10mm系列公制六角标准套筒: 8, 9, 10, 11, 12, 13, 14, 15, 16, 17, 18, 19, 20, 21, 22, 24mm
- 8件 10mm系列公制六角长套筒: 10, 11, 12, 13, 14, 15, 17, 19mm
- 2件 10mm系列火花塞套筒: 16, 21mm
- 2件 10mm系列接杆: 3", 10"
- 3件 10mm系列梨型头快速脱落胶柄棘轮扳手
10mm系列万向接头
10mm系列大小接头: 10mmx6.3mm

29件套12.5mm系列套筒组合

29 Pc Tool Set

- 采用优质铬钒钢 • Chrome-Vanadium steel
- 表面镀铬, 镜面抛光处理 • Chrome plated, mirror polished

CR-V 可配合钢盾工具车使用



Item no.	
S025023	1

- 19件 12.5mm系列公制六角标准套筒: 8, 9, 10, 11, 12, 13, 14, 15, 16, 17, 18, 19, 21, 22, 24, 27, 30, 32, 34mm
- 5件 12.5mm系列公制六角长套筒10, 13, 17, 19, 22mm
- 2件 12.5mm系列接杆5", 10"
- 3件 12.5mm系列梨型头快速脱落胶柄棘轮扳手
12.5mm系列万向接头
10mm系列三用接头10x12.5mm (带孔)

29件套扳手组合

29 Pc Wrench Set

- 采用优质铬钒钢
- 表面镀铬, 镜面抛光处理

- Chrome-Vanadium steel
- Chrome plated, mirror polished

CR-V 可配合钢盾工具车使用



Item no.	
S025026	1

- 11件 公制精抛光两用长扳手: 8, 10, 11, 12, 13, 14, 15, 16, 17, 18, 19mm
- 9件 公制加长球头内六角扳手: 1.5, 2, 2.5, 3, 4, 5, 6, 8, 10mm
- 9件 加长L型扳手: T10, T15, T20, T25, T27, T30, T40, T45, T50

4件套钳子组合

4 Pc Pliers Set

- 采用优质铬钒钢锻造, 坚固耐用
- 双色PP+TPR手柄, 握持舒适
- 刃口特殊热处理, 剪切能力强
- Forged from high grade chrome vanadium steel for durability
- Bi-material soft grip handle for comfort
- Heat-treated cutting edge stay sharper, longer

CR-V 可配合钢盾工具车使用



Item no.	
S025028	1

- 1件 双色柄尖嘴钳6"
- 1件 双色柄斜嘴钳6"
- 1件 双色柄钢丝钳8"
- 1件 水口钳6"

12件套双开口扳手组合

12 Pc Tool Set

- 采用优质铬钒钢 • Chrome-Vanadium steel
- 表面镀铬, 镜面抛光处理 • Chrome plated, mirror polished

CR-V 可配合钢盾工具车使用



Item no.	
S025024	1

- 12件 公制精抛光双开口扳手: 6x7, 8x10, 10x12, 11x13, 12x14, 13x15, 14x17, 17x19, 19x21, 21x23, 22x24, 24x27mm

12件套两用扳手组合

12 Pc Combination Wrench Set

- 采用优质铬钒钢
- 表面镀铬, 镜面抛光处理
- Chrome-Vanadium steel
- Chrome plated, mirror polished

CR-V 可配合钢盾工具车使用



Item no.	
S025027	1

- 12件 公制精抛光两用长扳手: 6, 7, 8, 10, 12, 13, 14, 16, 17, 19, 21, 24mm

5件套活动扳手大力钳组合

5 Pc Tool Set

- 采用优质铬钒钢锻造, 坚固耐用
- 表面镀铬处理, 美观防锈
- Forged from high performance chrome vanadium steel for durability
- Chrome plated for rust-resistant

CR-V 可配合钢盾工具车使用



Item no.	
S025029	1

- 1件 活动扳手10"
- 1件 钢丝钳8"
- 1件 尖嘴钳6"
- 1件 弧齿大力钳7"
- 1件 尖嘴带刃大力钳6.5"

11件套双梅花扳手组合

11 Pc Double Ring End Spanner Set

- 采用优质铬钒钢 • Chrome-Vanadium steel
- 表面镀铬, 镜面抛光处理 • Chrome plated, mirror polished

CR-V 可配合钢盾工具车使用



Item no.	
S025025	1

- 11件 公制精抛光双梅花扳手: 6x7, 8x10, 10x12, 11x13, 12x14, 14x17, 17x19, 19x21, 21x23, 22x24, 24x27mm

4件套卡簧钳组合

4 Pc Circlip Pliers Set

- 采用优质铬钒钢锻造，精抛光发黑处理
- 沾塑手柄，握持舒适
- Forged from high performance chrome vanadium steel
- Fine polished, black oxide finish
- Double-dipped grip handle for comfort

CR-V 可配合钢盾工具车使用



Item no.

S025030



1

- 1件 德式轴用直嘴卡簧钳7"
- 1件 德式轴用弯嘴卡簧钳7"
- 1件 德式孔用直嘴卡簧钳7"
- 1件 德式孔用弯嘴卡簧钳7"

8件套锉刀组合

8 Pc File Set

- 锉齿表面特殊热处理涂层，经久耐磨
- 双色PP+TPR手柄，握持舒适防滑
- Heat-treated & coated teeth for durability
- Bi-material soft grip for comfort

可配合钢盾工具车使用



Item no.

S025031



1

- 1件 双色手柄中齿平锉8"
- 1件 双色手柄中齿半圆锉8"
- 1件 双色手柄中齿方锉8"
- 1件 双色手柄中齿圆锉8"
- 1件 双色手柄中齿三角锉8"
- 1件 金刚石平头扁锉3x140mm
- 1件 金刚石尖头半圆锉3x140mm
- 1件 金刚石尖头圆锉3x140mm

14件套螺丝批组合

14 Pc Screwdriver Set

- 刀杆采用Cr-V-Mo优质钢材，表面镀铬处理
- 双色PP+TPR手柄，握持舒适
- High performance Cr-V-Mo blade, chrome plated
- Bi-material soft grip for comfort

CR-V-MO 可配合钢盾工具车使用



Item no.

S025032



1

- 1件 双色柄一字头螺丝刀5x75mm
- 1件 双色柄一字头螺丝刀6x100mm
- 1件 双色柄一字头螺丝刀6x150mm
- 1件 双色柄十字头螺丝刀 # 1x75mm
- 1件 双色柄十字头螺丝刀 # 2x100mm
- 1件 双色柄十字头螺丝刀 # 2x150mm
- 6件 精密螺丝批
- 1件 一字通体螺丝刀6X150mm
- 1件 十字通体螺丝刀PH2X150mm

汽保专用工具托组套 Automotive Tools

- 选用常用汽修工具进行专业组合，更加贴合客户使用习惯及需求
- 采用环保EVA材质，可配合钢盾工具车使用，方便工具管理规整
- S025041, S025042, S025043适用于工具车 S025006, S025007
- Selection of common auto repair tools for professional combination, more suitable for using habits and needs of customers
- Use environmentally friendly EVA material, can be used with Sheffield tool trolleys for structural tool management
- S025041, S025042, S025043 can be applied to tool trolleys S025006, S025007

新品

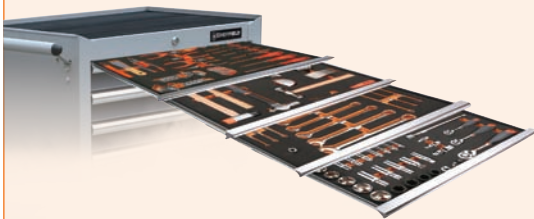

货号
S025041

品名
128件汽保通用维修组套

货号
S025042

品名
93件汽保专用轮胎服务组套

货号
S025043

品名
135件汽保钣金工具组套

S025041 - 128件汽保通用维修组套

货号	品名
S013000	6.3mm系列专业快速脱落棘轮扳手
S013100	10mm系列专业快速脱落棘轮扳手
S013200	12.5mm系列专业快速脱落棘轮扳手
S013210	12.5mm系列转向接杆5IN
S013211	12.5mm系列转向接杆10IN
S013110	10mm系列转向接杆3IN
S013111	10mm系列转向接杆6IN
S013010	6.3mm系列转向接杆2IN
S013006	6.3mm系列旋柄
S013007	6.3mm系列旋具头接头
S013002	6.3mm系列万向接头
S013102	10mm系列万向接头
S013202	12.5mm系列万向接头
S010105	6.3mm系列六角制套筒5mm
S010155	6.3mm系列六角制套筒5.5mm
S010106	6.3mm系列六角制套筒6mm
S010109	6.3mm系列六角制套筒9mm
S010110	6.3mm系列六角制套筒10mm
S010111	6.3mm系列六角制套筒11mm
S010112	6.3mm系列六角制套筒12mm
S013109	10mm系列三用接头10x12.5mm
S013105	10mm系列接头(10mm方孔x6.3mm方头)
S010609	10mm系列六角制套筒9mm
S010610	10mm系列六角制套筒10mm
S010611	10mm系列六角制套筒11mm
S010612	10mm系列六角制套筒12mm
S010613	10mm系列六角制套筒13mm
S010614	10mm系列六角制套筒14mm
S010615	10mm系列六角制套筒15mm
S010616	10mm系列六角制套筒16mm
S010617	10mm系列六角制套筒17mm
S010618	10mm系列六角制套筒18mm
S113043	T52气缸盖螺丝专用套筒
S011719	12.5mm系列六角制长套筒19mm
S011721	12.5mm系列六角制长套筒21mm
S011717	12.5mm系列六角制长套筒17mm
S011416	10mm系列火花塞套筒16mm
S011421	10mm系列火花塞套筒21mm
S010715	10mm系列六角制长套筒15mm
S010713	10mm系列六角制长套筒13mm
S010714	10mm系列六角制长套筒14mm
S010208	6.3mm系列六角制长套筒8mm
S010209	6.3mm系列六角制长套筒9mm

货号	品名
S010210	6.3MM系列六角制长套筒10mm
S010212	6.3MM系列六角制长套筒12mm
S014604	10MM系列六角旋具套筒 4mm
S014605	10MM系列六角旋具套筒 5mm
S014606	10MM系列六角旋具套筒 6mm
S014607	10MM系列六角旋具套筒 7mm
S014608	10MM系列六角旋具套筒 8mm
S014425	10MM系列花形旋具套筒 T - 25
S014427	10MM系列花形旋具套筒 T - 27
S014430	10MM系列花形旋具套筒 T - 30
S014440	10MM系列花形旋具套筒 T - 40
S011511	10MM系列六角花形套筒E - 11
S011512	10MM系列六角花形套筒E - 12
S011514	10MM系列六角花形套筒E - 14
S011516	10MM系列六角花形套筒E - 16
S011518	10MM系列六角花形套筒E - 18
S011520	10MM系列六角花形套筒E - 20
S011617	12.5MM系列六角制套筒17mm
S011618	12.5MM系列六角制套筒18mm
S011619	12.5MM系列六角制套筒19mm
S011620	12.5MM系列六角制套筒20mm
S011621	12.5MM系列六角制套筒21mm
S011622	12.5MM系列六角制套筒22mm
S011624	12.5MM系列六角制套筒24mm
S011627	12.5MM系列六角制套筒27mm
S011630	12.5MM系列六角制套筒30mm
S011632	12.5MM系列六角制套筒32mm
S123217	1/2" 标准型 风动套筒公制17mm
S123219	1/2" 标准型 风动套筒公制19mm
S123221	1/2" 标准型 风动套筒公制21mm
S123222	1/2" 标准型 风动套筒公制22mm
S113039	12.5mm系列M16油底壳放油套筒旋具头
S113024	减振器拆除专用套筒
S112003	两用滤清器扳手 63 - 102mm
S017108	公制全抛光两用扳手8mm
S017109	公制全抛光两用扳手9mm
S017110	公制全抛光两用扳手10mm
S017111	公制全抛光两用扳手11mm
S017112	公制全抛光两用扳手12mm
S017113	公制全抛光两用扳手13mm
S017114	公制全抛光两用扳手14mm
S017115	公制全抛光两用扳手15mm
S017116	公制全抛光两用扳手16mm

货号	品名
S017117	公制全抛光两用扳手17mm
S017118	公制全抛光两用扳手18mm
S017119	公制全抛光两用扳手19mm
S017121	公制全抛光两用扳手21mm
S017122	公制全抛光两用扳手22mm
S017124	公制全抛光两用扳手24mm
S045004	尖嘴钳6"
S045006	斜嘴钳6"
S045003	钢丝钳8"
S047026	德式轴用直口卡簧钳7"
S047022	德式轴用曲口卡簧钳7"
S047034	德式六用直口卡簧钳7"
S047030	德式六用曲口卡簧钳7"
S050016	9件套L型中孔花型扳手
S050008	9件套公制长内六角扳手
S058101	一字型穿心螺丝批6x100mm
S058201	十字型穿心螺丝批6x100mm
S058203	十字型穿心螺丝批8x150mm
S056102	一字型塑柄螺丝批3.2x75mm
S056106	一字型塑柄螺丝批5x75mm
S056202	十字型塑柄螺丝批0#x75mm
S056206	十字型塑柄螺丝批1#x75mm
S056112	一字型塑柄螺丝批6x38mm
S056212	十字型塑柄螺丝批2#x38mm
S104008	重型管子钳8"
S016610	新型活动扳手10"
S048003	圆口带刃大力钳10"
S044011	鲤鱼钳 8"
S112011	手铐式滤清器扳手55 - 75mm
S112012	手铐式滤清器扳手75 - 95mm
S019108	公制全抛光油管扳手8x10mm
S019109	公制全抛光油管扳手9x11mm
S019113	公制全抛光油管扳手13x14mm
S030002	铝合金手电筒3节7#电池
S034001	带频率测量掌上型万用表
S115001	测电笔
S080002	5件套样冲
S080222	扁凿20mm
S117001	5件套断丝取出器
S125003	1/2" 专业型强力冲击扳手
S088316	玻璃纤维柄圆头锤16OZ
S125011	气动低速轮胎打磨机

S025042 - 93件汽保专用轮胎服务组套

货号	品名
S013100	10mm系列专业快速脱落棘轮扳手
S013200	12.5mm系列专业快速脱落棘轮扳手
S044011	鲤鱼钳 8"
S013109	10mm系列三用接头10x12.5mm
S013205	12.5mm系列三用接头12.5x10mm
S013210	12.5mm系列转向接杆5IN
S013211	12.5mm系列转向接杆10IN
S013110	10mm系列转向接杆3IN
S013111	10mm系列转向接杆6IN
S013203	12.5mm系列滑杆
S013202	12.5mm系列万向接头
S013102	10mm系列万向接头
S048003	圆口带刃大力钳10"
S123206	风动万向接头1/2"x1/2"(MxF)
S011716	12.5mm系列六角制长套筒16mm
S011717	12.5mm系列六角制长套筒17mm
S011718	12.5mm系列六角制长套筒18mm

货号	品名
S011719	12.5mm系列六角制长套筒19mm
S011720	12.5mm系列六角制长套筒20mm
S011721	12.5mm系列六角制长套筒21mm
S011722	12.5mm系列六角制长套筒22mm
S010608	10mm系列六角制套筒8mm
S010609	10mm系列六角制套筒9mm
S010610	10mm系列六角制套筒10mm
S010611	10mm系列六角制套筒11mm
S010612	10mm系列六角制套筒12mm
S010613	10mm系列六角制套筒13mm
S010614	10mm系列六角制套筒14mm
S010616	10mm系列六角制套筒16mm
S123217	1/2" 标准型 风动套筒公制17mm
S123219	1/2" 标准型 风动套筒公制19mm
S123221	1/2" 标准型 风动套筒公制21mm
S123222	1/2" 标准型 风动套筒公制22mm
S123223	1/2" 标准型 风动套筒公制23mm

货号	品名
S011612	12.5mm系列六角制套筒12mm
S011613	12.5mm系列六角制套筒13mm
S011614	12.5mm系列六角制套筒14mm
S011615	12.5mm系列六角制套筒15mm
S011616	12.5mm系列六角制套筒16mm
S011617	12.5mm系列六角制套筒17mm
S011618	12.5mm系列六角制套筒18mm
S011619	12.5mm系列六角制套筒19mm
S011620	12.5mm系列六角制套筒20mm
S011621	12.5mm系列六角制套筒21mm
S011622	12.5mm系列六角制套筒22mm
S011623	12.5mm系列六角制套筒23mm
S011624	12.5mm系列六角制套筒24mm
S011627	12.5mm系列六角制套筒27mm
S016610	新型活动扳手10"
S104008	重型管子钳8"
S104010	重型管子钳10"

【下页续】

【续上页】S025042-93件汽保专用轮胎服务组套

货号	品名
S017110	公制全抛光两用扳手10mm
S017111	公制全抛光两用扳手11mm
S017112	公制全抛光两用扳手12mm
S017113	公制全抛光两用扳手13mm
S017114	公制全抛光两用扳手14mm
S017116	公制全抛光两用扳手16mm
S017117	公制全抛光两用扳手17mm
S017118	公制全抛光两用扳手18mm
S017119	公制全抛光两用扳手19mm
S017120	公制全抛光两用扳手20mm
S017121	公制全抛光两用扳手21mm
S017122	公制全抛光两用扳手22mm
S017124	公制全抛光两用扳手24mm
S017125	公制全抛光两用扳手25mm

货号	品名
S017608	公制全抛光30度双梅花扳手 8x10mm
S017611	公制全抛光30度双梅花扳手 11x13mm
S017612	公制全抛光30度双梅花扳手 12x14mm
S017617	公制全抛光30度双梅花扳手 17x19mm
S077005	凯锐系列钢卷尺5mx19mm
S030002	铝合金手电筒3节7#电池
S045004	尖嘴钳6"
S045006	斜嘴钳6"
S045003	钢丝钳8"
S044015	超级省力顶切钳8"
S068001	双色柄多用剪8"
S117012	吹尘枪250mm
S056102	一字型塑柄螺丝批3.2x75mm
S056202	十字型塑柄螺丝批0#x75mm

货号	品名
S056113	一字型塑柄螺丝批6x100mm
S056213	十字型塑柄螺丝批2#x100mm
S058102	一字型穿心螺丝批6x150mm
S058202	十字型穿心螺丝批6x150mm
S112014	木柄刮刀
S067007	9mm钎合金美工刀
S113040	指针式公斤扳手
S117002	十字轮胎扳手
S125011	气动低速轮胎打磨机
S125003	1/2"专业型强力冲击扳手
S113027	平衡钳
S011416	10mm系列火花塞套筒16mm
S011421	10mm系列火花塞套筒21mm
S112003	两用滤清器扳手 63-102mm

S025043-135件汽保钣金工具组套

货号	品名
S013000	6.3mm系列专业快速脱落棘轮扳手
S013100	10mm系列专业快速脱落棘轮扳手
S013200	12.5mm系列专业快速脱落棘轮扳手
S013210	12.5mm系列转向接杆5IN
S013211	12.5mm系列转向接杆10IN
S013110	10mm系列转向接杆3IN
S013111	10mm系列转向接杆6IN
S013010	6.3mm系列转向接杆2IN
S013006	6.3mm系列旋柄
S013007	6.3mm系列旋具头接头
S013002	6.3mm系列万向接头
S013102	10mm系列万向接头
S013202	12.5mm系列万向接头
S010105	6.3mm系列六角公制套筒5mm
S010155	6.3mm系列六角公制套筒5.5mm
S010106	6.3mm系列六角公制套筒6mm
S010107	6.3mm系列六角公制套筒7mm
S010108	6.3mm系列六角公制套筒8mm
S010109	6.3mm系列六角公制套筒9mm
S010110	6.3mm系列六角公制套筒10mm
S010111	6.3mm系列六角公制套筒11mm
S010112	6.3mm系列六角公制套筒12mm
S013109	10mm系列三用接头10x12.5mm
S013205	12.5mm系列三用接头12.5x10mm
S013105	10mm系列接头(10mm方孔x6.3mm方头)
S010609	10mm系列六角公制套筒9mm
S010610	10mm系列六角公制套筒10mm
S010611	10mm系列六角公制套筒11mm
S010612	10mm系列六角公制套筒12mm
S010613	10mm系列六角公制套筒13mm
S010614	10mm系列六角公制套筒14mm
S010615	10mm系列六角公制套筒15mm
S010616	10mm系列六角公制套筒16mm
S010617	10mm系列六角公制套筒17mm
S010618	10mm系列六角公制套筒18mm
S113043	T52气缸盖螺丝专用套筒
S011719	12.5mm系列六角公制长套筒19mm
S011721	12.5mm系列六角公制长套筒21mm
S011717	12.5mm系列六角公制长套筒17mm
S011416	10mm系列火花塞套筒16mm
S011421	10mm系列火花塞套筒21mm
S010715	10mm系列六角公制长套筒15mm
S010713	10mm系列六角公制长套筒13mm
S010714	10mm系列六角公制长套筒14mm
S010208	6.3mm系列六角公制长套筒8mm
S010209	6.3mm系列六角公制长套筒9mm

货号	品名
S010210	6.3mm系列六角公制长套筒10mm
S010212	6.3mm系列六角公制长套筒12mm
S014604	10mm系列六角旋具套筒 4mm
S014605	10mm系列六角旋具套筒 5mm
S014606	10mm系列六角旋具套筒 6mm
S014607	10mm系列六角旋具套筒 7mm
S014608	10mm系列六角旋具套筒 8mm
S014425	10mm系列花形旋具套筒 T-25
S014427	10mm系列花形旋具套筒 T-27
S014430	10mm系列花形旋具套筒 T-30
S014440	10mm系列花形旋具套筒 T-40
S011511	10mm系列六角花形套筒 E-11
S011512	10mm系列六角花形套筒 E-12
S011514	10mm系列六角花形套筒 E-14
S011516	10mm系列六角花形套筒 E-16
S011518	10mm系列六角花形套筒 E-18
S011520	10mm系列六角花形套筒 E-20
S011617	12.5mm系列六角公制套筒17mm
S011618	12.5mm系列六角公制套筒18mm
S011619	12.5mm系列六角公制套筒19mm
S011620	12.5mm系列六角公制套筒20mm
S011621	12.5mm系列六角公制套筒21mm
S011622	12.5mm系列六角公制套筒22mm
S011624	12.5mm系列六角公制套筒24mm
S011627	12.5mm系列六角公制套筒27mm
S011630	12.5mm系列六角公制套筒30mm
S011632	12.5mm系列六角公制套筒32mm
S123217	1/2" 标准型 风动套筒公制17mm
S123219	1/2" 标准型 风动套筒公制19mm
S123221	1/2" 标准型 风动套筒公制21mm
S123222	1/2" 标准型 风动套筒公制22mm
S113039	12.5mm系列M16油底壳放油套筒旋具头
S113024	减振器拆除专用套筒
S112003	两用滤清器扳手 63-102mm
S017108	公制全抛光两用扳手8mm
S017109	公制全抛光两用扳手9mm
S017110	公制全抛光两用扳手10mm
S017111	公制全抛光两用扳手11mm
S017112	公制全抛光两用扳手12mm
S017113	公制全抛光两用扳手13mm
S017114	公制全抛光两用扳手14mm
S017115	公制全抛光两用扳手15mm
S017116	公制全抛光两用扳手16mm
S017117	公制全抛光两用扳手17mm
S017118	公制全抛光两用扳手18mm
S017119	公制全抛光两用扳手19mm

货号	品名
S017121	公制全抛光两用扳手21mm
S017122	公制全抛光两用扳手22mm
S017124	公制全抛光两用扳手24mm
S045004	尖嘴钳6"
S045003	钢丝钳8"
S047026	德式轴用直口卡簧钳7"
S047022	德式轴用直口卡簧钳7"
S047034	德式六用直口卡簧钳7"
S047030	德式六用直口卡簧钳7"
S050016	9件套长L型中孔花型扳手
S050008	9件套公制长内六角扳手
S058101	一字型穿心螺丝批6x100mm
S058201	十字型穿心螺丝批6x100mm
S058203	十字型穿心螺丝批8x150mm
S056102	一字型塑柄螺丝批3.2x75mm
S056106	一字型塑柄螺丝批5x75mm
S056202	十字型塑柄螺丝批0#x75mm
S056206	十字型塑柄螺丝批1#x75mm
S056112	一字型塑柄螺丝批6x38mm
S056212	十字型塑柄螺丝批2#x38mm
S080002	5件套样冲
S080222	扁凿20mm
S117001	5件套断丝取出器
S088316	玻璃纤维柄圆头锤16OZ
S090004	5件套金刚石整形锉
S099506	中齿方锉8"
S099305	中齿圆锉6"
S099405	中齿三角锉6"
S099201	粗齿半圆锉6"
S116006	轻式缩减钣金锤320g
S116008	鹤嘴精整钣金锤260g
S112002	起子刮刀
S112014	木柄刮刀
S116005	铲型钣金衬铁
S116003	弯型钣金衬铁
S116002	墩型钣金衬铁
S006004	扁型钣金衬铁
S048008	焊接用大力钳9"
S048007	尖嘴带刃大力钳9"
S048010	C型大力钳11"
S048009	铁皮大力钳8"
S088735	木柄安装锤35mm
S088630	木柄钳工锤300g

6.3mm 系列公制6角标准套筒

6.3mm Drive Standard 6pt Socket

- 1/4"方头驱动
- 采用优质铬钒钢
- 表面镀铬,镜面抛光处理
- 1/4 In. drive
- Chrome-Vanadium steel
- Chrome plated,mirror polished

1/4" CR-V

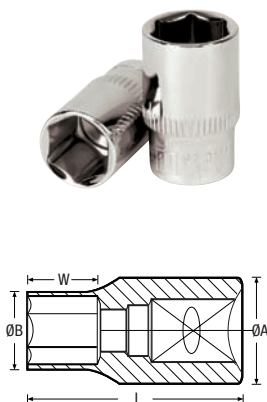

Item no.	Size (mm)	L (mm)	W (mm)	ØA (mm)	ØB (mm)	
S010104	4	25	5.6	11.6	6.9	12
S010145	4.5	25	5.6	11.6	7.3	12
S010105	5	25	6.2	11.6	8.1	12
S010155	5.5	25	6.2	11.6	9.2	12
S010106	6	25	6.8	11.6	9.2	12
S010107	7	25	7.4	11.6	10.9	12
S010108	8	25	7.4	11.8	11.8	12
S010109	9	25	8	12.6	12.6	12
S010110	10	25	8	13.5	13.5	12
S010111	11	25	10	14	15.5	12
S010112	12	25	10	15	16.8	12
S010113	13	25	10	15	17.7	12
S010114	14	25	12	17.2	19.8	12

10mm 系列公制6角标准套筒

10mm 6pt Socket

- 3/8"方头驱动
- 采用优质铬钒钢
- 表面镀铬,镜面抛光处理
- 3/8 In. drive
- Chrome-Vanadium steel
- Chrome plated,mirror polished

3/8" CR-V

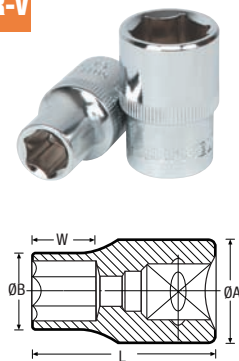

Item no.	Size (mm)	L (mm)	W (mm)	ØA (mm)	ØB (mm)	
S010606	6	25.7	7	16.9	10.1	12
S010607	7	25.7	8	16.9	10.6	12
S010608	8	25.7	8	16.9	11.6	12
S010609	9	25.7	8.5	16.9	13.2	12
S010610	10	25.7	9	16.9	14.5	12
S010611	11	25.7	10	16.9	15.5	12
S010612	12	25.7	10.5	15.6	16.8	12
S010613	13	25.7	10.5	15	17.7	12
S010614	14	25.7	12	17	19.8	12
S010615	15	25.7	12	19.1	20.8	12
S010616	16	29	15.5	18.9	21.8	12
S010617	17	29	15.5	19.7	23.9	12
S010618	18	29	16	21.7	25.85	12
S010619	19	29	16	21.9	25.7	12
S010620	20	29	16	24	28.1	12
S010621	21	29	16	24	27.8	12
S010622	22	29	16	25.9	29.8	12
S010624	24	29	16	27.1	31.7	12

10mm 系列公制6角长套筒

10mm Drive Deep 6pt Socket

- 3/8"方头驱动
- 采用优质铬钒钢
- 表面镀铬,镜面抛光处理
- 3/8 In. drive
- Chrome-Vanadium steel
- Chrome plated,mirror polished

3/8" CR-V

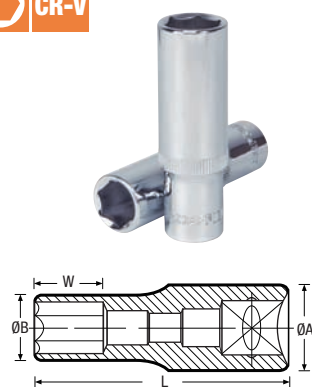

Item no.	Size (mm)	L (mm)	W (mm)	ØA (mm)	ØB (mm)	
S010708	8	45.5	12	16.7	11.5	12
S010709	9	45.5	14	16.7	13	12
S010710	10	45.5	15	16.7	14.1	12
S010711	11	45.5	17	16.7	15.7	12
S010712	12	45.5	18	16.6	17.8	12
S010713	13	45.5	18	17	18.9	12
S010714	14	50	18	17	19.8	12
S010715	15	53	20	18.8	20.8	12
S010716	16	53	20	19	21.9	12
S010717	17	53	20	19.6	23.7	12
S010718	18	56	20	22.1	25.7	12
S010719	19	56	20	21.8	25.8	12
S010720	20	63.5	22	23.9	27.9	12
S010721	21	63.5	22	24.1	27.7	12
S010722	22	63.5	22	25.8	29.6	12

6.3mm 系列公制6角长套筒

6.3mm Drive Deep 6pt Socket

- 1/4"方头驱动
- 采用优质铬钒钢
- 表面镀铬,镜面抛光处理
- 1/4 In. drive
- Chrome-Vanadium steel
- Chrome plated,mirror polished

1/4" CR-V



Item no.	Size (mm)	L (mm)	W (mm)	ØA (mm)	ØB (mm)	
S010204	4	49.5	7	11.6	6.6	12
S010205	5	49.5	7.5	11.7	8	12
S010206	6	49.5	8.5	11.7	9.1	12
S010207	7	49.5	12.5	11.75	10.6	12
S010208	8	49.5	12.5	11.75	11.75	12
S010209	9	49.5	13.5	13	13	12
S010210	10	49.5	15	14.6	14.6	12
S010211	11	49.5	16	14.8	15.6	12
S010212	12	49.5	17	14.8	16.7	12
S010213	13	49.5	19	15.6	17.7	12

10mm系列公制6角火花塞套筒

10mm Drive 6pt Spark Plug Socket

- 3/8"方头驱动
- 采用优质铬钒钢
- 表面镀铬,镜面抛光处理
- 3/8 In. drive
- Chrome-Vanadium steel
- Chrome plated,mirror polished

CR-V 3/8"

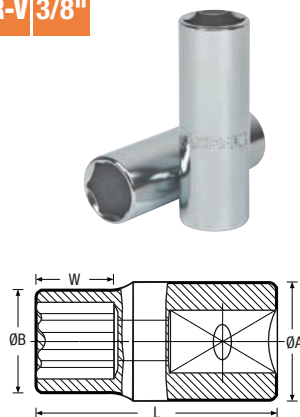

Item no.	Size (mm)	L (mm)	W (mm)	ØA (mm)	ØB (mm)	
S011414	14	63	21	18	20	12
S011416	16	65	14	18.7	21.87	12
S011421	21	65	11	22	28	12

10mm 系列花形套筒

10mm Drive Torx Socket Wrench

- 3/8"方头驱动
- 采用优质铬钒钢
- 表面镀铬,镜面抛光处理
- 3/8 In. drive
- Chrome-Vanadium steel
- Chrome plated,mirror polished

3/8" CR-V

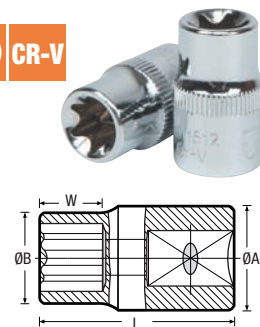

Item no.	Size (mm)	L (mm)	W (mm)	ØA (mm)	ØB (mm)	
S011508	E8	29	8	16.8	11.1	12
S011510	E10	29	10	16.7	13.2	12
S011511	E11	29	10	16.8	13.7	12
S011512	E12	29	10	16.8	14.7	12
S011514	E14	29	11	16.6	17.7	12
S011516	E16	29	11	18.8	19.7	12
S011518	E18	29	12	20.8	21.7	12
S011520	E20	29	12	19.9	23.8	12

12.5mm系列公制6角标准套筒

12.5mm Drive Standard 6pt Socket

- 1/2"方头驱动
- 采用优质铬钒钢
- 表面镀铬,镜面抛光处理
- 1/2 In. drive
- Chrome-Vanadium steel
- Chrome plated,mirror polished

1/2" CR-V

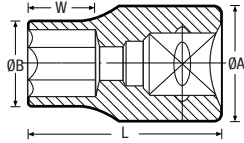

Item no.	Size (mm)	L (mm)	W (mm)	ØA (mm)	ØB (mm)	
S011608	8	38	10	21.7	13.2	12
S011609	9	38	12	21.7	14.3	12
S011610	10	38	12	21.7	15.5	12
S011611	11	38	12	21.7	16.3	12
S011612	12	38	12	21.7	17.6	12
S011613	13	38	12	21.8	19.1	12
S011614	14	38	12	21.7	20.4	12
S011615	15	38	14	20.7	21.7	12
S011616	16	38	14	20.7	21.7	12
S011617	17	38	14	21.8	23.9	12
S011618	18	38	14	22.9	25.6	12
S011619	19	38	18	22.9	25.6	12
S011620	20	38	18	24	27.6	12
S011621	21	38	18	24	27.6	12
S011622	22	40	18	26	29.8	12
S011623	23	40	20	28.1	31.6	12
S011624	24	40	20	28.1	31.6	12
S011627	27	43	21	30.2	35.7	12
S011630	30	43	21	34.1	39.7	12
S011632	32	43	22	36.3	41.6	12
S011634	34	45.5	23.5	38	43.8	12

12.5mm系列公制6角长套筒

12.5mm Drive Deep 6pt Socket

- 1/2"方头驱动
- 采用优质铬钒钢
- 表面镀铬,镜面抛光处理
- 1/2 In. drive
- Chrome-Vanadium steel
- Chrome plated,mirror polished

1/2" CR-V

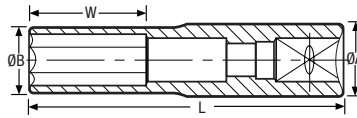

Item no.	Size (mm)	L (mm)	W (mm)	ØA (mm)	ØB (mm)	
S011710	10	79	17	21.8	16.6	12
S011712	12	79	19	21.8	17.5	12
S011713	13	79	21	21.8	18.7	12
S011714	14	79	25	21.8	20.3	12
S011715	15	79	28	20.8	21.8	12
S011716	16	79	31	20.8	21.8	12
S011717	17	79	34	22.1	23.8	12
S011718	18	79	34	22.8	25.8	12
S011719	19	79	36	21.9	25.9	12
S011720	20	79	36	23.9	27	12
S011721	21	79	36	23.8	27.6	12
S011722	22	79	36	26	29.8	12
S011724	24	79	34	28	31.8	12
S011727	27	79	34	31.9	35.7	12

12.5mm系列公制12角标准套筒

12.5mm Drive Standard 12pt Socket

- 1/2"方头驱动
- 采用优质铬钒钢
- 表面镀铬,镜面抛光处理
- 1/2 In. drive
- Chrome-Vanadium steel
- Chrome plated,mirror polished

1/2" CR-V

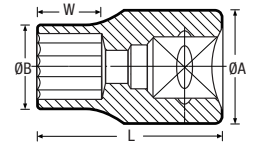

Item no.	Size (mm)	L (mm)	W (mm)	ØA (mm)	ØB (mm)	
S012008	8	38	10	21.7	13.2	12
S012010	10	38	12	21.7	15.5	12
S012011	11	38	12	21.7	16.3	12
S012012	12	38	12	21.7	17.6	12
S012013	13	38	12	21.8	19.1	12
S012014	14	38	12	21.7	20.4	12
S012015	15	38	16	20.7	21.7	12
S012016	16	38	16	20.7	21.7	12
S012017	17	38	16	21.8	23.9	12
S012018	18	38	16	22.9	25.6	12
S012019	19	38	18	22.9	25.6	12
S012020	20	38	18	24	27.6	12
S012021	21	38	18	24	27.6	12
S012022	22	40	18	26	29.8	12
S012023	23	40	20	28.1	31.6	12
S012024	24	40	20	28.1	31.6	12
S012025	25	40	20	32.8	32.8	12
S012026	26	43	21	29.1	34.3	12
S012027	27	43	21	30.1	34.3	12
S012030	30	43	21	34.1	39.7	12
S012032	32	43	22	36.3	41.6	12

12.5mm 系列公制6角火花塞套筒

12.5mm Socket

- 1/2"方头驱动
- 采用优质铬钒钢
- 表面镀铬,镜面抛光处理
- 1/2 In. drive
- Chrome-Vanadium steel
- Chrome plated,mirror polished

1/2" CR-V

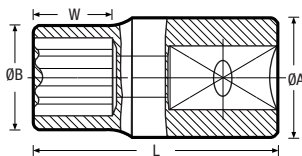

Item no.	Size (mm)	L (mm)	W (mm)	ØA (mm)	ØB (mm)	
S012416	16	45.5	12	16.5	12	12
S012421	21	45.5	14	16.5	13.1	12

12.5mm 系列公制12角长套筒

12.5mm Drive Deep 12PT Socket

- 1/2"方头驱动
- 采用优质铬钒钢
- 表面镀铬,镜面抛光处理
- 1/2 In. drive
- Chrome-Vanadium steel
- Chrome plated,mirror polished

1/2" CR-V

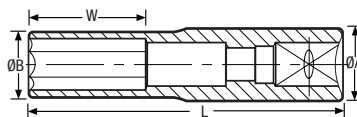

Item no.	Size (mm)	L (mm)	W (mm)	ØA (mm)	ØB (mm)	
S012110	10	79	17	21.8	16.6	12
S012112	12	79	19	21.8	17.5	12
S012113	13	79	21	21.8	18.7	12
S012114	14	79	25	21.8	20.3	12
S012117	17	79	34	22.1	23.8	12
S012119	19	79	36	21.9	25.9	12

12.5mm系列英制12角标准套筒

12.5mm Drive Standard 12pt Socket

- 1/2"方头驱动
- 采用优质铬钒钢
- 表面镀铬,镜面抛光处理
- 1/2 In. drive
- Chrome-Vanadium steel
- Chrome plated,mirror polished

1/2" CR-V

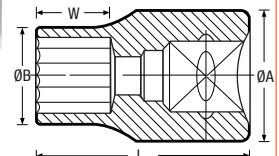

Item no.	Size (mm)	L (mm)	W (mm)	ØA (mm)	ØB (mm)	
S012201	1/4"	38	12	21.8	10.4	12
S012202	5/16"	38	10	21.8	13.5	12
S012203	3/8"	38	12	21.8	14.5	12
S012204	7/16"	38	12	21.8	15.5	12
S012205	1/2"	38	12	21.8	18.7	12
S012206	9/16"	38	16	22.8	20.8	12
S012207	19/32"	38	14	20.8	21.8	12
S012208	5/8"	38	14	20.8	21.8	12
S012209	11/16"	38	14	21.8	23.9	12
S012210	3/4"	38	18	22.9	26	12
S012211	25/32"	38	18	23.9	28	12
S012212	13/16"	38	18	23.9	28	12
S012213	7/8"	40	20	26	29.1	12
S012214	15/16"	40	20	28	32.2	12
S012215	1"	40	20	30.1	33.3	12
S012216	1-1/16"	43	21	30.1	35.4	12
S012217	1-1/8"	43	21	32.2	37.4	12
S012218	1-3/16"	43	21	34.3	39.5	12
S012219	1-1/4"	43	22	35.4	41.6	12

19mm 系列公制12角标准套筒

19mm Drive 12pt Socket

- 3/4"方头驱动
- 采用优质铬钼钢
- 表面镀铬,镜面抛光处理
- 3/4 In. drive
- Chrome-molybdenum steel
- Chrome plated,mirror polished

3/4" CR-MO

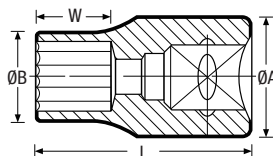
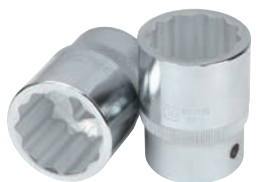

Item no.	Size (mm)	L (mm)	W (mm)	ØA (mm)	ØB (mm)	
S012819	19	49.5	14	29.2	33	4
S012821	21	49.5	14	31.2	33	4
S012822	22	49.5	14	32.2	36	4
S012824	24	49.5	16	34.2	36	4
S012826	26	50	16	37	36	4
S012827	27	52	22	38	36	4
S012829	29	52	22	40	38	4
S012830	30	54	24	42	38	4
S012832	32	56	24	44	38	4
S012834	34	56	26	47	38	4
S012836	36	58	28	50	42	4
S012838	38	60	28	52	45	4
S012841	41	64	30	56	45	4
S012846	46	68	34	62	47	2
S012850	50	72	36	68	48	2
S012855	55	76	38	74	48	2
S012860	60	78	40	80	48	2

6.3mm 系列钢柄快脱棘轮扳手

1/4 In. Drive Ratchet

- 1/4"驱动方头, 43齿棘轮
- 采用优质铬钒钢
- 表面镀铬,镜面抛光处理
- 1/4 In. drive, reversible, 43-teeth gear
- Chrome-Vanadium steel
- Chrome plated,mirror polished

1/4" CR-V

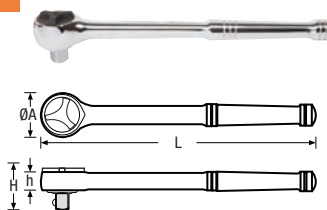

Item no.	L (mm)	ØA (mm)	H (mm)	h (mm)	
S013001	144	24.5	22.3	11.5	6

6.3mm 系列万向接头

1/4 In. Drive Universal Joint

- 1/4"驱动方头
- 采用优质铬钒钢
- 表面镀铬,镜面抛光处理
- 1/4 In. drive
- Chrome-Vanadium steel
- Chrome plated,mirror polished

1/4" CR-V

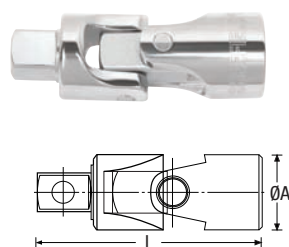

Item no.	Size	L (mm)	ØA (mm)	
S013002	1/4"	34	14	12

棘轮扳手 Ratchet

- 采用优质合金钢材质,整体锻造,热处理加工,扭力超强。
- 双色PP耐油手柄,坚固耐用。
- 双向棘轮,使用轻松快速。
- 36齿齿轮设计,适合狭小空间使用。
- 快速脱落功能设计,更轻松自如装卸套筒安全可靠
- Quick release head and reversing lever.
- Chrome-Vanadium steel
- Ergonomic rubberized grip
- Bi-color PP oil-resistant handle, mirror polished



快速脱落功能设计,更轻松自如装卸套筒,安全可靠。
The release head simplifies attachment and removal of sockets. A ball locking device ensures a tight connection when the ratchet is in use.



双向棘轮,使用轻松快速。
Easy change lever for clockwise and anti-clockwise movement.



36齿齿轮设计,适合狭小空间使用。
36-teeth gear

双色PP耐油手柄,坚固耐用。

2-Component handle,comprising a hard core with rubber sheathing for heavy industrial use. Hanging hole for easy-to-find storage of the ratchet.



6.3mm 系列专业快脱胶柄棘轮扳手

1/4 In. Drive Ratchet

- 1/4"驱动方头,快速脱落双向调节,36齿棘轮
- 采用优质铬钒钢
- 表面镀铬,镜面抛光处理
- 双色耐油手柄,坚固耐用
- 1/4 In. drive, reversible, 36-teeth gear
- Chrome-Vanadium steel
- Chrome plated,mirror polished
- Bi-color oil-resistant handle, sturdy and durable

1/4" CR-V

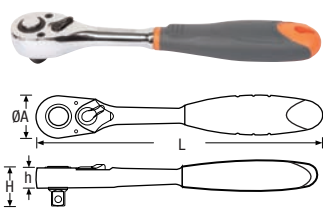

Item no.	L (mm)	ØA (mm)	H (mm)	h (mm)	
S013000	157	24.5	22.3	13	6

6.3mm 系列T型滑杆

1/4 In. T-Slider

- 1/4"驱动方头
- 采用优质铬钒钢
- 表面镀铬,镜面抛光处理
- 1/4 In. drive
- Chrome-Vanadium steel
- Chrome plated,mirror polished

1/4" CR-V

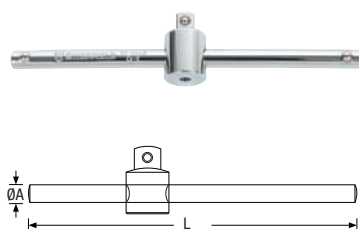

Item no.	Size	L (mm)	ØA (mm)	
S013003	1/4"	108	6.4	12

6.3mm 系列大小接头
1/4 In. Adaptor

- 1/4"方头驱动
- 采用优质铬钒钢
- 表面镀铬,镜面抛光处理
- 1/4 In. drive
- Chrome-Vanadium steel
- Chrome plated,mirror polished

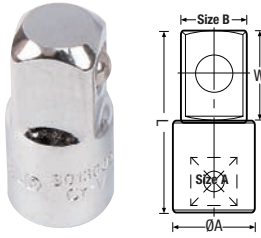
1/4" CR-V

Item no.	Size A	Size B	L (mm)	W (mm)	ØA (mm)	
S013005	1/4"	3/8"	25	10.5	12.4	12

6.3mm 系列接杆
1/4 In. Extension Bar

- 1/4"驱动方头
- 采用优质铬钒钢
- 表面镀铬,镜面抛光处理
- 1/4 In. drive
- Chrome-Vanadium steel
- Chrome plated,mirror polished

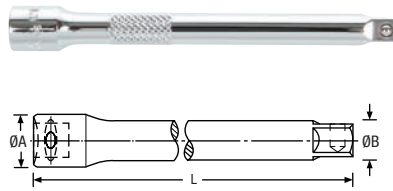
1/4" CR-V

Item no.	Size	L(mm)	ØA(mm)	ØB(mm)	
S013010	2"	50	12.5	8.2	12
S013011	4"	100	12.5	8.2	12

10mm 系列万向接头
3/8 In. Drive Universal Joint

- 3/8"驱动方头
- 采用优质铬钒钢
- 表面镀铬,镜面抛光处理
- 3/8 In. drive
- Chrome-Vanadium
- Chrome plated,mirror polished

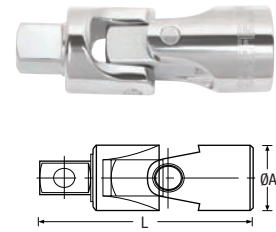
3/8" CR-V

Item no.	Size	L(mm)	ØA(mm)	
S013102	3/8"	54.2	19	12

6.3mm 系列旋柄
1/4 In. Spinner Handle

- 1/4" 驱动方头
- 采用优质铬钒钢
- 表面镀铬,镜面抛光处理
- 底部方孔可接1/4"棘轮扳手
- 1/4 In. drive
- Chrome-Vanadium steel
- Chrome plated, mirror polished
- Square hole in the bottom can connect 1/4 In. ratchet

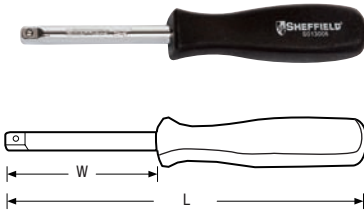
1/4"

Item no.	L(mm)	W(mm)	
S013006	150	65	12

10mm系列专业快脱胶柄棘轮扳手
3/8 In. Drive Ratchet

- 3/8"驱动方头,快速脱落双向调节,36齿棘轮
- 采用优质铬钒钢
- 表面镀铬,镜面抛光处理
- 双色耐油手柄,坚固耐用
- 3/8 In. drive, reversible, 36-teeth gear
- Chrome-Vanadium steel
- Chrome plated, mirror polished
- Bi-color oil-resistant handle, sturdy and durable

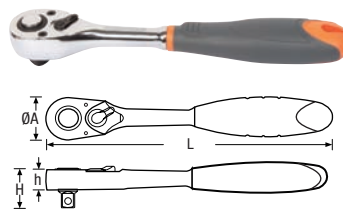
3/8" CR-V

Item no.	L(mm)	ØA(mm)	H(mm)	h(mm)	
S013100	195	31.5	30	17.4	6

10mm 系列T型滑杆
3/8 In. T-Slider

- 3/8"驱动方头
- 采用优质铬钒钢
- 表面镀铬,镜面抛光处理
- 3/8 In. drive
- Chrome-Vanadium
- Chrome plated,mirror polished

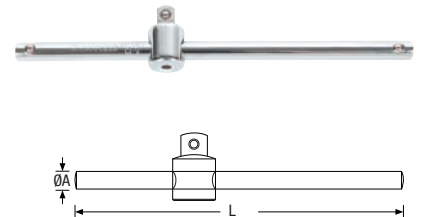
3/8" CR-V

Item no.	Size	L(mm)	ØA(mm)	
S013103	3/8"	200	10	12

6.3mm 系列起子变换头
1/4 In. Bit Holder

- 1/4"方头驱动
- 采用优质铬钒钢
- 表面镀铬,镜面抛光处理
- 1/4 In. drive
- Chrome-Vanadium steel
- Chrome plated,mirror polished

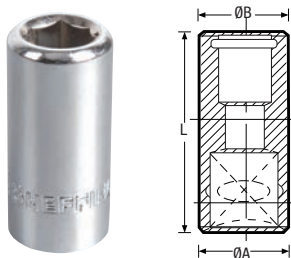
1/4" CR-V

Item no.	Size	L(mm)	ØA(mm)	ØB(mm)	
S013007	1/4"	25	14	10.8	12

10mm 系列钢柄快脱棘轮扳手
3/8 In. Drive Ratchet

- 3/8"驱动方头,快速脱落,41齿棘轮
- 采用优质铬钒钢
- 表面镀铬,镜面抛光处理
- 3/8 In. drive, reversible, 41-teeth gear
- Chrome-Vanadium
- Chrome plated,mirror polished

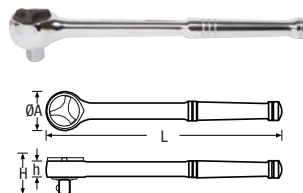
3/8" CR-V

Item no.	L(mm)	ØA(mm)	H(mm)	h(mm)	
S013101	201	36.5	35.7	15.6	6

10mm 系列大小接头
3/8 In. Adaptor

- 3/8"方头驱动
- 采用优质铬钒钢
- 表面镀铬,镜面抛光处理
- 3/8 In. drive
- Chrome-Vanadium
- Chrome plated,mirror polished

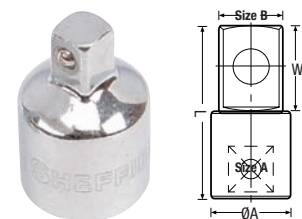
3/8" CR-V

Item no.	Size A	Size B	L (mm)	W (mm)	ØA (mm)	
S013105	3/8"	1/4"	25.4	7	17	12

起子变头头

Bit Holder

- 采用优质铬钒钢
- 表面镀铬, 镜面抛光处理
- Chrome-Vanadium steel
- Chrome plated, mirror polished

3/8" 1/2" CR-V

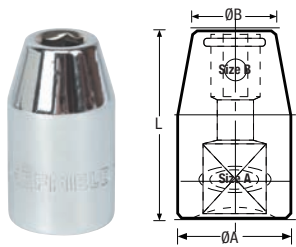

Item no.	Size	Size A	L(mm)	ØA(mm)	ØB(mm)	
S013107	3/8"	8mm	29	17	13	12
S013207	1/2"	8mm	38	24.7	15	12

12.5mm系列专业快脱胶柄棘轮扳手

1/2 In. Drive Ratchet

- 1/2"驱动方头, 快速脱落双向调节, 36齿棘轮
- 采用优质铬钒钢
- 表面镀铬, 镜面抛光处理
- 双色耐油手柄, 坚固耐用
- 1/2 In. drive, reversible, 36-teeth gear
- Chrome-Vanadium steel
- Chrome plated, mirror polished
- Bi-color oil-resistant handle, sturdy and durable

1/2" CR-V

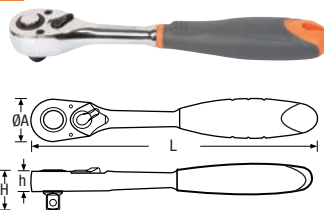

Item no.	L(mm)	ØA(mm)	H(mm)	h(mm)	
S013200	251	42	26.5	18	6

12.5mm 系列T型滑杆

1/2 In. T-Slider

- 1/2"驱动方头
- 采用优质铬钒钢
- 表面镀铬, 镜面抛光处理
- 1/2 In. drive
- Chrome-Vanadium steel
- Chrome plated, mirror polished

1/2" CR-V

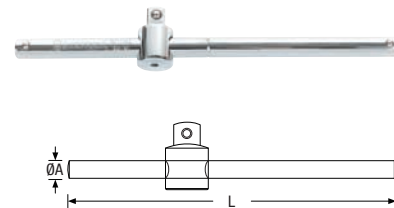

Item no.	Size	L(mm)	ØA(mm)	
S013203	1/2"	243	12.7	12

10mm 系列三用接头

3/8 In. Tee-joint

- 3/8"方头驱动
- 采用优质铬钒钢
- 表面镀铬, 镜面抛光处理
- 3/8 In. drive
- Chrome-Vanadium
- Chrome plated, mirror polished

3/8" CR-V

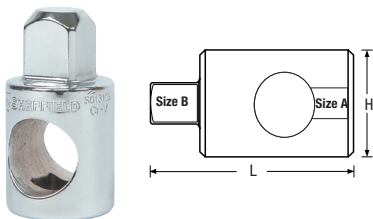

Item no.	Size A	Size B	L(mm)	H(mm)	
S013109	3/8"	1/2"	43	24	12

12.5mm 系列钢柄快脱棘轮扳手

1/2 In. Drive Ratchet

- 1/2"驱动方头, 快速脱落, 45齿棘轮
- 采用优质铬钒钢
- 表面镀铬, 镜面抛光处理
- 1/2 In. drive, reversible, 45-teeth gear
- Chrome-Vanadium steel
- Chrome plated, mirror polished

1/2" CR-V

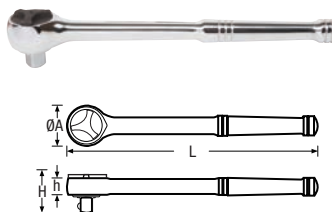

Item no.	L(mm)	ØA(mm)	H(mm)	h(mm)	
S013201	255	43.5	42.2	17.6	6

12.5mm 系列F型套筒扳杆

1/2 In. F-handle

- 1/2"驱动方头
- 采用优质铬钒钢
- 表面镀铬, 镜面抛光处理
- 1/2 In. drive
- Chrome-Vanadium steel
- Chrome plated, mirror polished

1/2" CR-V

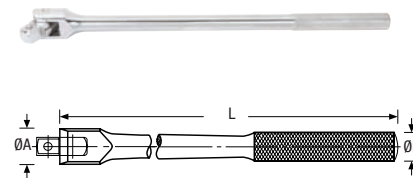

Item no.	Size	L(mm)	ØA(mm)	ØB(mm)	
S013204	1/2"	250	30	19	12
S013206	1/2"	375	30	19	12

10mm 系列接杆

3/8 In. Extension Bar

- 3/8"驱动方头
- 采用优质铬钒钢
- 表面镀铬, 镜面抛光处理
- 3/8 In. drive
- Chrome-Vanadium
- Chrome plated, mirror polished

3/8" CR-V

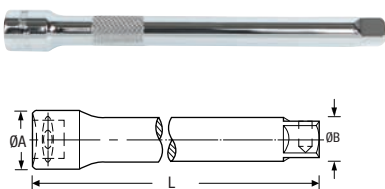

Item no.	Size	L (mm)	ØA (mm)	ØB (mm)	
S013110	3"	76.2	17	12.3	12
S013111	6"	152.4	17	12.3	12
S013112	10"	254	17	12.3	12

12.5mm 系列万向接头

1/2 In. Drive Universal Joint

- 1/2"驱动方头
- 采用优质铬钒钢
- 表面镀铬, 镜面抛光处理
- 1/2 In. drive
- Chrome-Vanadium steel
- Chrome plated, mirror polished

1/2" CR-V

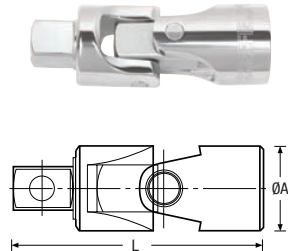

Item no.	Size	L(mm)	ØA(mm)	
S013202	1/2"	68.5	24.9	12

12.5mm 系列大小接头

1/2 In. Adaptor

- 1/2"方头驱动
- 采用优质铬钒钢
- 表面镀铬, 镜面抛光处理
- 1/2 In. drive
- Chrome-Vanadium steel
- Chrome plated, mirror polished

1/2" CR-V

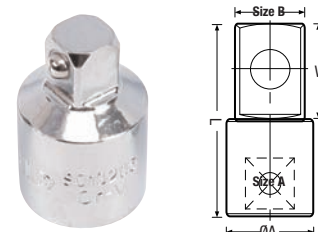

Item no.	Size A	Size B	L (mm)	W (mm)	ØA (mm)	
S013205	1/2"	3/8"	34.5	10.5	22	12

12.5mm 系列L型套筒扳杆

1/2 In. L-handle

- 1/2"驱动方头
- 采用优质铬钒钢
- 表面镀铬,镜面抛光处理
- 1/2 In. drive
- Chrome-Vanadium steel
- Chrome plated,mirror polished

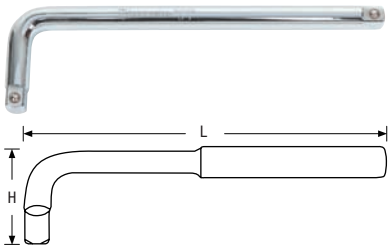
1/2" CR-V

Item no.	Size	L(mm)	H(mm)	
S013208	1/2"	250	50	12

19mm 系列快速脱落棘轮扳手

3/4 In. Drive Ratchet Wrench

- 3/4"驱动方头,快速脱落双向调节,36齿棘轮
- 采用优质铬钼钢
- 表面镀铬,镜面抛光处理
- 滚花手柄,防滑耐用
- 3/4 In. drive, reversible, 36-teeth gear
- Chrome-Molybdenum steel
- Ergonomic rubberized grip
- Chrome plated,mirror polished

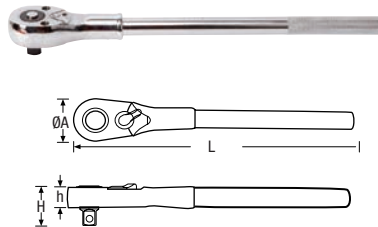
3/4" CR-MO

Item no.	L(mm)	ØA(mm)	H(mm)	h(mm)	
S013301	510	42	26.5	18	2

19mm 系列F型套筒扳杆

3/4 In. F-handle

- 3/4"驱动方头
- 采用优质铬钒钢
- 表面镀铬,镜面抛光处理
- 3/4 In. drive
- Chrome-Vanadium steel
- Chrome plated,mirror polished

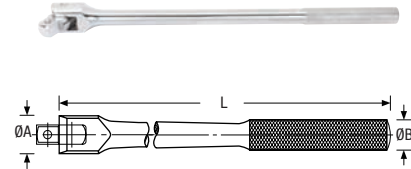
3/4" CR-V

Item no.	Size	L(mm)	ØA(mm)	ØB(mm)	
S013304	3/4"	504	41	25	3

12.5mm 系列接杆

1/2 In. Extension Bar

- 1/2"驱动方头
- 采用优质铬钒钢
- 表面镀铬,镜面抛光处理
- 1/2 In. drive
- Chrome-Vanadium steel
- Chrome plated,mirror polished

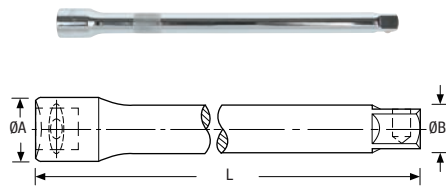
1/2" CR-V

Item no.	Size	L(mm)	ØA(mm)	ØB(mm)	
S013210	5"	127	22.5	16.3	12
S013211	10"	254	22.5	16.3	12

19mm 系列万向接头

3/4 In. Drive Universal Joint

- 3/4"驱动方头
- 采用优质铬钼钢
- 表面镀铬,镜面抛光处理
- 3/4 In. drive
- Chrome-Molybdenum steel
- Chrome plated,mirror polished

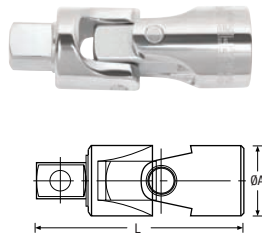
3/4" CR-MO

Item no.	Size	L(mm)	ØA(mm)	
S013302	3/4"	110	40	4

19mm 系列L型套筒扳杆

3/4 In. L-handle

- 3/4"驱动方头
- 采用优质铬钼钢
- 表面镀铬,镜面抛光处理
- 3/4 In. drive
- Chrome-Molybdenum steel
- Chrome plated,mirror polished

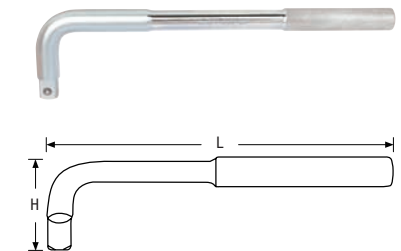
3/4" CR-MO

Item no.	Size	L(mm)	H(mm)	
S013309	3/4"	460	100	3

12.5mm 系列弓型杆

Speeder Handle

- 1/2"驱动方头
- 采用优质铬钒钢
- 表面镀铬,镜面抛光处理
- 1/2 In. drive
- Chrome-Vanadium steel
- Chrome plated,mirror polished

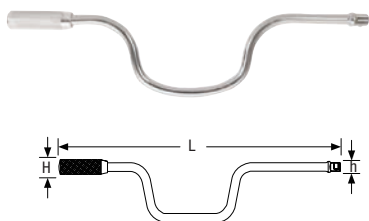
1/2" CR-V

Item no.	Size	L(mm)	H(mm)	h(mm)	
S013220	1/2"	420	38	24.7	6

19mm 系列T型滑杆

3/4 In. T-Slider

- 3/4"驱动方头
- 采用优质铬钼钢
- 表面镀铬,镜面抛光处理
- 3/4 In. drive
- Chrome-Molybdenum steel
- Chrome plated,mirror polished

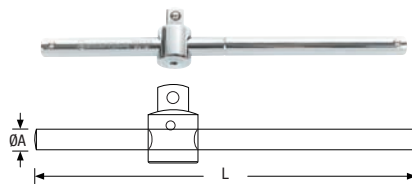
3/4" CR-MO

Item no.	Size	L(mm)	ØA(mm)	
S013303	3/4"	480	20	3

19mm 系列接杆

3/4 In. Extension Bar

- 3/4"驱动方头
- 采用优质铬钼钢
- 表面镀铬,镜面抛光处理
- 3/4 In. drive
- Chrome-Molybdenum steel
- Chrome plated,mirror polished

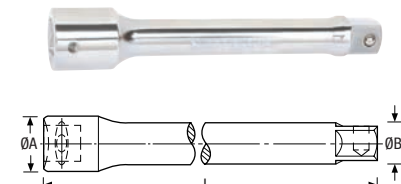
3/4" CR-MO

Item no.	Size	L(mm)	ØA(mm)	ØB(mm)	
S013310	4"	100	36	22	6
S013311	8"	200	36	22	4

6.3mm 系列十字型旋具套筒

1/4 In. Phillips Bit Socket

- 套筒：1/4"方头驱动
- 采用优质铬钒钢
- 表面镀铬，镜抛处理
- 旋具头：S2高级合金钢，镀镍处理
- Socket: 1/4 In. drive
- Chrome-Vanadium steel
- Chrome plated, mirror polished
- Bit: S2, Chrome-Nickle plated 镀镍处理

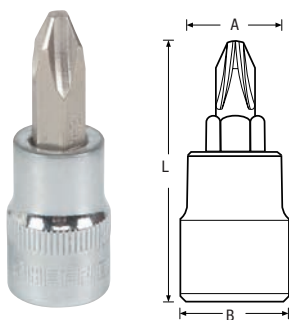

Item no.	Size	L(mm)	A(mm)	B(mm)	
S013501	PH1	37	11	12	12
S013502	PH2	37	11	12	12

6.3mm 系列花型旋具套筒

1/4 In. Torx Bit Socket

- 套筒：1/4"方头驱动
- 采用优质铬钒钢
- 表面镀铬，镜抛处理
- 旋具头：S2高级合金钢，镀镍处理
- Socket: 1/4 In. drive
- Chrome-Vanadium steel
- Chrome plated, mirror polished
- Bit: S2, Chrome-Nickle plated 镀镍处理

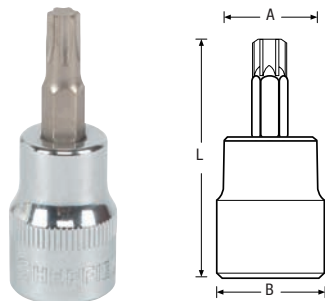

Item no.	Size	L(mm)	A(mm)	B(mm)	
S013808	T-08	37	11	12	12
S013810	T-10	37	11	12	12
S013815	T-15	37	11	12	12
S013820	T-20	37	11	12	12
S013825	T-25	37	11	12	12
S013827	T-27	37	11	12	12
S013830	T-30	37	11	12	12
S013840	T-40	37	11	12	12

10mm 系列十字型旋具套筒

3/8 In. Phillips Bit Socket

- 套筒：3/8"方头驱动
- 采用优质铬钒钢
- 表面镀铬，镜抛处理
- 旋具头：S2高级合金钢，镀镍处理
- Socket: 3/8 In. drive
- Chrome-Vanadium steel
- Chrome plated, mirror polished
- Bit: S2, Chrome-Nickle plated 镀镍处理

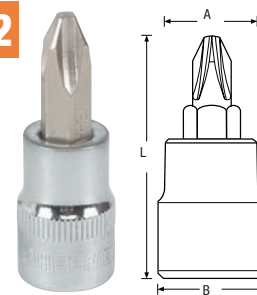

Item no.	Size	L(mm)	A(mm)	B(mm)	
S014101	PH1	48	14	17.9	12
S014102	PH2	48	14	17.9	12
S014103	PH3	48	14	17.9	12

10mm 系列米字型旋具套筒

3/8 In. Pozi Bit Socket

- 套筒：3/8"方头驱动
- 采用优质铬钒钢
- 表面镀铬，镜抛处理
- 旋具头：S2高级合金钢，镀镍处理
- Socket: 3/8 In. drive
- Chrome-Vanadium steel
- Chrome plated, mirror polished
- Bit: S2, Chrome-Nickle plated 镀镍处理

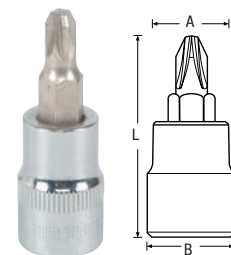

Item no.	Size	L(mm)	A(mm)	B(mm)	
S014301	PZ1	48	14	17.9	12
S014302	PZ2	48	14	17.9	12
S014303	PZ3	48	14	17.9	12

6.3mm 系列一字型旋具套筒

1/4 In. Slotted Bit Socket

- 套筒：1/4"方头驱动
- 采用优质铬钒钢
- 表面镀铬，镜抛处理
- 旋具头：S2高级合金钢，镀镍处理
- Socket: 1/4 In. drive
- Chrome-Vanadium steel
- Chrome plated, mirror polished
- Bit: S2, Chrome-Nickle plated 镀镍处理

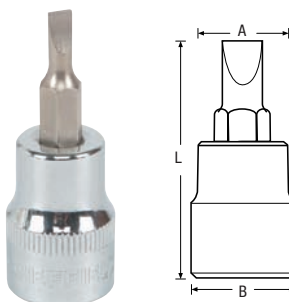

Item no.	Size(mm)	L(mm)	A(mm)	B(mm)	
S013604	4	37	11	12	12
S013655	5.5	37	11	12	12
S013665	6.5	37	11	12	12

6.3mm 系列六角旋具套筒

1/4 In. Hex Bit Socket

- 套筒：1/4"方头驱动
- 采用优质铬钒钢
- 表面镀铬，镜抛处理
- 旋具头：S2高级合金钢，镀镍处理
- Socket: 1/4 In. drive
- Chrome-Vanadium steel
- Chrome plated, mirror polished
- Bit: S2, Chrome-Nickle plated 镀镍处理

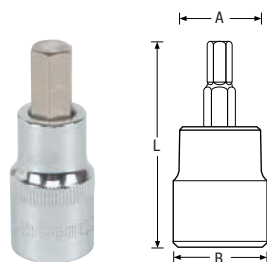

Item no.	Size(mm)	L(mm)	A(mm)	B(mm)	
S013903	H3	37	11	12	12
S013904	H4	37	11	12	12
S013905	H5	37	11	12	12
S013906	H6	37	11	12	12
S013907	H7	37	11	12	12
S013908	H8	37	11	12	12
S013910	H10	37	11	12	12

10mm 系列一字型旋具套筒

3/8 In. Slotted Bit Socket

- 套筒：3/8"方头驱动
- 采用优质铬钒钢
- 表面镀铬，镜抛处理
- 旋具头：S2高级合金钢，镀镍处理
- Socket: 3/8 In. drive
- Chrome-Vanadium steel
- Chrome plated, mirror polished
- Bit: S2, Chrome-Nickle plated 镀镍处理

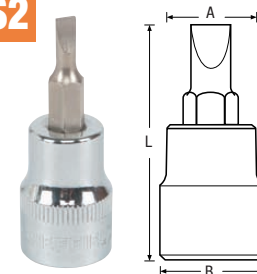

Item no.	Size(mm)	L(mm)	A(mm)	B(mm)	
S014204	4	48	14	17.9	12
S014255	5.5	48	14	17.9	12
S014265	6.5	48	14	17.9	12
S014208	8	48	14	17.9	12

10mm 系列花型旋具套筒
3/8 In. Torx Bit Socket

- 套筒：3/8"方头驱动
- 采用优质铬钒钢
- 表面镀铬，镜抛处理
- 旋具头：S2高级合金钢，电镀处理
- Socket: 3/8 In. drive
- Chrome-Vanadium steel
- Chrome plated, mirror polished
- Bit: S2 ,Chrome-Nickle plated

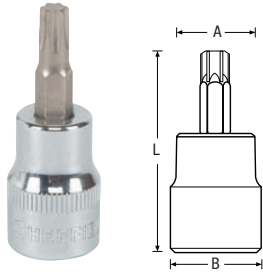

Item no.	Size	L(mm)	A(mm)	B(mm)	
S014410	T-10	48	14	17.9	12
S014415	T-15	48	14	17.9	12
S014420	T-20	48	14	17.9	12
S014425	T-25	48	14	17.9	12
S014427	T-27	48	14	17.9	12
S014430	T-30	48	14	17.9	12
S014440	T-40	48	14	17.9	12
S014445	T-45	48	14	17.9	12
S014450	T-50	48	14	17.9	12
S014455	T-55	48	14	17.9	12
S014460	T-60	48	14	17.9	12

12.5mm系列长花型旋具套筒
1/2 In. Torx Long Bit Socket

- 套筒：1/2"方头驱动
- 采用优质铬钒钢
- 表面镀铬，镜抛处理
- 旋具头：S2高级合金钢，电镀处理
- Socket: 1/2 In. drive
- Chrome-Vanadium steel
- Chrome plated, mirror polished
- Bit: S2 ,Chrome-Nickle plated

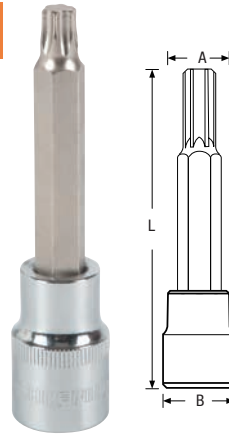

Item no.	Size	L(mm)	A(mm)	B(mm)	
S015220	T-20	100	18	22	12
S015225	T-25	100	18	22	12
S015227	T-27	100	18	22	12
S015230	T-30	100	18	22	12
S015240	T-40	100	18	22	12
S015245	T-45	100	18	22	12
S015250	T-50	100	18	22	12
S015255	T-55	100	18	22	12
S015260	T-60	100	18	22	12

12.5mm 系列公制6角旋具套筒
1/2 In. Hex Bit Socket

- 套筒：1/2"方头驱动
- 采用优质铬钒钢
- 表面镀铬，镜抛处理
- 旋具头：S2高级合金钢，电镀处理
- Socket: 1/2 In. drive
- Chrome-Vanadium steel
- Chrome plated, mirror polished
- Bit: S2 ,Chrome-Nickle plated

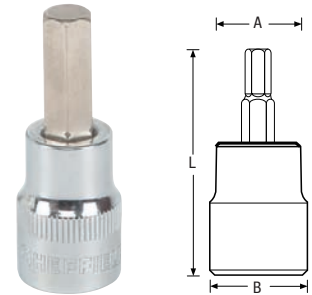

Item no.	Size(mm)	L(mm)	A(mm)	B(mm)	
S015305	H5	55	18	22	12
S015306	H6	55	18	22	12
S015308	H8	55	18	22	12
S015310	H10	55	18	22	12
S015312	H12	55	18	22	12
S015314	H14	55	18	22	12
S015317	H17	55	18	22	12

10mm系列公制6角旋具套筒
3/8 In. Hex Bit Socket

- 套筒：3/8"方头驱动
- 采用优质铬钒钢
- 表面镀铬，镜抛处理
- 旋具头：S2高级合金钢，电镀处理
- Socket: 3/8 In. drive
- Chrome-Vanadium steel
- Chrome plated, mirror polished
- Bit: S2 ,Chrome-Nickle plated

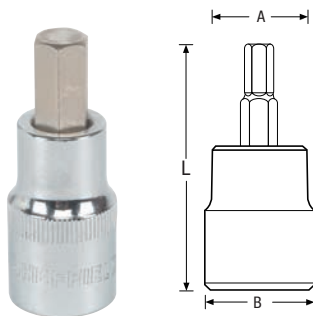

Item no.	Size(mm)	L(mm)	A(mm)	B(mm)	
S014603	H3	48	14	18	12
S014604	H4	48	14	18	12
S014605	H5	48	14	18	12
S014606	H6	48	14	18	12
S014607	H7	48	14	18	12
S014608	H8	48	14	18	12
S014610	H10	48	14	18	12

12.5mm系列长花型旋具套筒
1/2 In. Torx Long Bit Socket

- 套筒：1/2"方头驱动
- 采用优质铬钒钢
- 表面镀铬，镜抛处理
- 旋具头：S2高级合金钢，电镀处理
- Socket: 1/2 In. drive
- Chrome-Vanadium steel
- Chrome plated, mirror polished
- Bit: S2 ,Chrome-Nickle plated

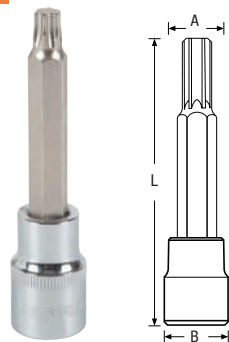

Item no.	Size	L(mm)	A(mm)	B(mm)	
S015120	T-20	55	18	22	12
S015125	T-25	55	18	22	12
S015127	T-27	55	18	22	12
S015130	T-30	55	18	22	12
S015140	T-40	55	18	22	12
S015145	T-45	55	18	22	12
S015150	T-50	55	18	22	12

12.5mm系列公制6角长旋具套筒
1/2 In. Hex Long Bit Socket

- 套筒：1/2"方头驱动
- 采用优质铬钒钢
- 表面镀铬，镜抛处理
- 旋具头：S2高级合金钢，电镀处理
- Socket: 1/2 In. drive
- Chrome-Vanadium steel
- Chrome plated, mirror polished
- Bit: S2 ,Chrome-Nickle plated

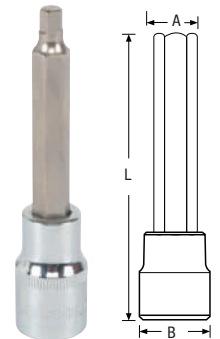

Item no.	Size(mm)	L(mm)	A(mm)	B(mm)	
S015505	5	100	18	22	12
S015425	5	180	18	22	12
S015506	6	100	18	22	12
S015426	6	70	18	22	12
S015436	6	250	18	22	12
S015446	6	140	18	22	12
S015507	7	100	18	22	12
S015428	8	120	18	22	12
S015508	8	100	18	22	12
S015420	10	140	18	22	12
S015510	10	100	18	22	12
S015512	12	100	18	22	12
S015514	14	100	18	22	12

12.5mm系列公制12角长旋具套筒

1/2 In. 12PT Bit Socket

- 套筒：1/2"方头驱动
- 采用优质铬钒钢
- 表面镀铬，镜抛处理
- 旋具头：S2高级合金钢，镀镍处理
- Socket: 1/2 In. drive
- Chrome-Vanadium steel
- Chrome plated, mirror polished
- Bit: S2, Chrome-Nickle plated

1/2" S2

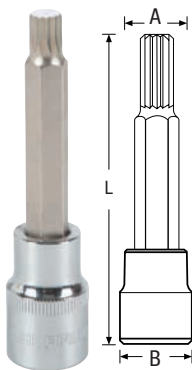

Item no.	Size	L(mm)	A(mm)	B(mm)	
S015806	M6	100	18	22	12
S015808	M8	100	18	22	12
S015810	M10	100	18	22	12
S015812	M12	100	18	22	12

12.5mm系列公制12角长旋具套筒

1/2 In. 12PT Bit Socket

- 套筒：1/2"方头驱动
- 采用优质铬钒钢
- 表面镀铬，镜抛处理
- 旋具头：S2高级合金钢，镀镍处理
- Socket: 1/2 In. drive
- Chrome-Vanadium steel
- Chrome plated, mirror polished
- Bit: S2, Chrome-Nickle plated

1/2" S2

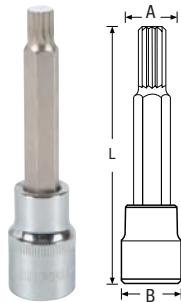

Item no.	Size	L(mm)	A(mm)	B(mm)	
S015278	M6	55	18	22	12
S015279	M8	55	18	22	12
S015280	M10	55	18	22	12
S015281	M12	55	18	22	12
S015282	M14	55	18	22	12
S015283	M16	55	18	22	12

公制T型套筒

T Socket Wrench

- 套筒，采用优质铬钒钢，表面镀铬，雾面处理
- 手柄镀铬处理
- Socket: Chrome-Vanadium, Matte chrome plated
- Handle: chrome plated

CR-V

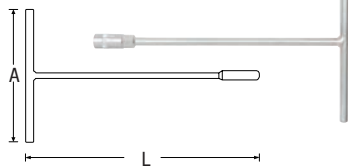

Item no.	Size(mm)	L(mm)	A(mm)	
S016008	8	310	200	10
S016010	10	310	200	10
S016012	12	310	200	10
S016013	13	310	250	10
S016014	14	310	250	10
S016017	17	315	250	10
S016019	19	315	250	10

活扳手

Adjustable Wrench

- 表面镀铬
- 半抛处理
- 激光刻度
- Chrome plated
- Semi polished
- Laser scale

升级

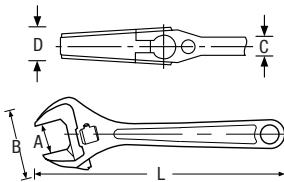

Item no.	Size (Inch)	L (mm)	A (mm)	B (mm)	C (mm)	D (mm)	
S016604	4	100	13	31	8.7	14.4	6
S016606	6	150	19.3	44.5	11.1	18.4	6
S016608	8	200	24	55.5	12.6	23	6
S016610	10	250	30	68.5	15.2	28	6
S016612	12	300	36	82	18	32	6

沾塑柄活络扳手

Adjustable Wrench

- 表面镀铬
- 半抛处理
- 沾塑手柄
- 激光刻度
- Chrome plated
- Semi polished
- Soft dip grip handle
- Laser scale

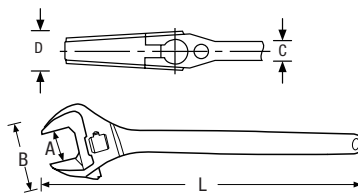

Item no.	Size (Inch)	L (mm)	A (mm)	B (mm)	C (mm)	D (mm)	
S016615	15	375	46	103	23.2	39	4
S016618	18	450	55	120	25.6	45.8	2
S016624	24	609	62	139	28.2	35.8	1

重型活扳手

Heavy Duty Adjustable Wrench

- 采用优质铬钒钢
- 表面镀铬
- 半抛处理
- 激光刻度
- Chrome-Vanadium steel
- Chrome plated
- Semi polished
- Laser scale

CR-V

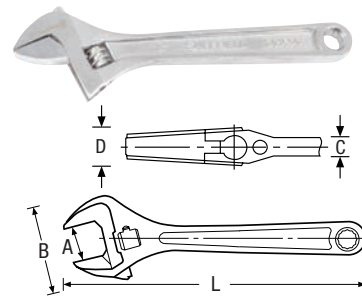

Item no.	Size (Inch)	L (mm)	A (mm)	B (mm)	C (mm)	D (mm)	
S016906	6	150	19.3	44.5	11.1	18.4	6
S016908	8	200	24	55.5	12.6	23	6
S016910	10	250	30	68.5	15.2	28	6
S016912	12	300	36	82	18	32	6

套柄活扳手

Adjustable Wrench

- 采用优质铬钒钢
- 表面镀铬，半抛处理
- 双色套柄使用更舒适
- 激光刻度
- Chrome-Vanadium steel
- Chrome plated, Semi polished
- Dual-material comfort grip handle
- Laser scale

CR-V

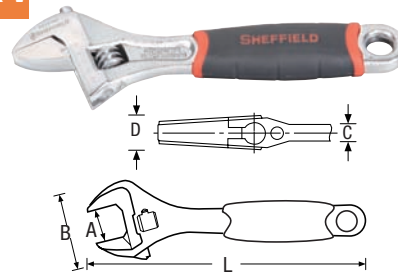

Item no.	Size (Inch)	L (mm)	A (mm)	B (mm)	C (mm)	D (mm)	
S016706	6	150	19.3	44.5	11.1	18.4	6
S016708	8	200	24	55.5	12.6	23	6
S016710	10	250	30	68.5	15.2	28	6
S016712	12	300	36	82	18	32	6

9件套公制精抛光两用长扳手组套

9 Pc Combination Wrench Set

- 采用优质铬钒钢
- 表面镀铬，镜抛处理
- Chrome-Vanadium steel
- Chrome plated, mirror polished

CR-V



Item no.	
S017104	1
8, 10, 11, 12, 13, 14, 15, 17, 19mm	

11件套公制精抛光两用长扳手套组
11Pc Combination Wrench Set

- 采用优质铬钒钢
- 表面镀铬, 镜抛处理
- Chrome-Vanadium steel
- Chrome plated, mirror polished

CR-V

Item no.

S017105

8, 9, 10, 11, 12, 13, 14, 15, 17, 19, 22mm



1

14件套英制精抛光两用扳手
14 Pc Combination Wrench Set

- 采用优质铬钒钢
- 表面镀铬, 镜面抛光处理
- Chrome-Vanadium steel
- Chrome plated, mirror polished

CR-V

Item no.

S017401

3/8", 7/16", 1/2", 9/16", 5/8", 11/16", 3/4", 13/16", 7/8", 15/16", 1", 1-1/16", 1-1/8", 1-1/4"



1

9件套公制精抛光两用长扳手套组
9 Pc Combination Wrench Set

- 采用优质铬钒钢
- 表面镀铬, 镜抛处理
- Chrome-Vanadium steel
- Chrome plated, mirror polished

CR-V

Item no.

S017100

8, 10, 11, 12, 13, 14, 15, 17, 19mm



1

23件套公制精抛光两用长扳手套组
23 Pc Combination Wrench Set

- 采用优质铬钒钢
- 表面镀铬, 镜抛处理
- Chrome-Vanadium steel
- Chrome plated, mirror polished

CR-V

Item no.

S017103

6, 7, 8, 9, 10, 11, 12, 13, 14, 15, 16, 17, 18, 19, 20, 21, 22, 23, 24, 25, 27, 30, 32mm



1

14件套公制凹筋两用扳手套组
14PC Combination Wrench Set

- 采用优质钢材锻造, 整体热处理加工
- 欧式凹筋款式, 表面镀铬处理
- Forged from high-grade alloy steel, heat-treated
- European ribbed style, chrome plated for rust-resistant

CR-V
新品

Item no.

S017303

8, 9, 10, 11, 12, 13, 14, 15, 16, 17, 18, 19, 22, 24mm



1

11件套公制精抛光两用长扳手套组
11 Pc Combination Wrench Set

- 采用优质铬钒钢
- 表面镀铬, 镜抛处理
- Chrome-Vanadium steel
- Chrome plated, mirror polished

CR-V

Item no.

S017101

8, 9, 10, 11, 12, 13, 14, 15, 17, 19, 22mm



1

21件套公制凹筋两用扳手套组
21 Pc Combination Wrench Set

- 采用优质钢材锻造, 整体热处理加工
- 欧式凸筋款式, 表面镀铬处理
- Forged from high-grade alloy steel, heat-treated
- European ribbed style, chrome plated for rust-resistant

CR-V

Item no.

S017301

7, 8, 9, 10, 11, 12, 13, 14, 15, 16, 17, 18, 19, 20, 21, 22, 24, 27, 30, 32mm



1

23件套公制凹筋两用扳手套组
23PC Combination Wrench Set

- 采用优质钢材锻造, 整体热处理加工
- 欧式凹筋款式, 表面镀铬处理
- Forged from high-grade alloy steel, heat-treated
- European ribbed style, chrome plated for rust-resistant

CR-V
新品

Item no.

S017304

6, 7, 8, 9, 10, 11, 12, 13, 14, 15, 16, 17, 18, 19, 20, 21, 22, 23, 24, 25, 27, 30, 32mm



1

14件套公制精抛光两用长扳手套组
14 Pc Combination Wrench Set

- 采用优质铬钒钢
- 表面镀铬, 镜抛处理
- Chrome-Vanadium steel
- Chrome plated, mirror polished

CR-V

Item no.

S017102

8, 9, 10, 11, 12, 13, 14, 15, 16, 17, 18, 19, 22, 24mm



1

11件套英制精抛光两用扳手

11 Pc Combination Wrench Set

- 采用优质铬钒钢
- 表面镀铬, 镜抛处理
- Chrome-Vanadium steel
- Chrome plated, mirror polished

CR-V



Item no.	1
S017402	1
1/4", 5/16", 3/8", 7/16", 1/2", 9/16", 5/8", 11/16", 3/4", 13/16", 7/8"	

13件套公制精抛光双梅花扳手

13 Pc Double Ring End Spanner Set

- 采用优质铬钒钢
- 表面镀铬, 镜抛处理
- Chrome-Vanadium steel
- Chrome plated, mirror polished

CR-V



Item no.	1
S017603	1
6X7, 8X10, 10X12, 11X13, 12X14, 14X17, 17X19, 19X21, 21X23, 22X24, 23X26, 24X27, 30X32mm	

公制精抛光两用长扳手

Combination Wrench

- 采用优质铬钒钢
- 表面镀铬, 镜抛处理
- Chrome-Vanadium steel
- Chrome plated, mirror polished

CR-V

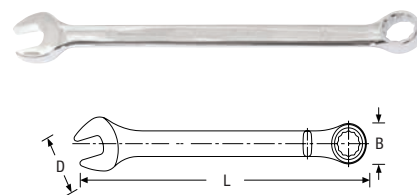

Item no.	Size (mm)	L (mm)	B (mm)	D (mm)	T (mm)
S017155	5.5	128	11	14	12
S017106	6	128	11	14	12
S017107	7	138.2	12.7	15.4	12
S017108	8	148.3	13.9	17.6	12
S017109	9	160.3	15	19.8	12
S017110	10	167.3	16.2	22	12
S017111	11	186.3	17.9	24.1	12
S017112	12	196.4	19.1	25.9	12
S017113	13	205.4	20.7	27.3	12
S017114	14	223.4	22.3	30.6	12
S017115	15	233.4	23.5	32.2	12
S017116	16	243.4	24.7	33.7	12
S017117	17	262.4	26.9	36.6	12
S017118	18	272.4	28.2	38.4	12
S017119	19	281.4	29.2	40.2	12
S017120	20	290.4	30.5	41.7	12
S017121	21	301.4	31.8	43.2	6
S017122	22	319.4	34.3	46.5	6
S017123	23	319.4	34.3	46.5	6
S017124	24	339.4	36	49.7	6
S017125	25	358.4	37	52.9	6
S017127	27	388.4	40.5	56.1	6
S017130	30	404.5	42.8	59.2	4
S017132	32	431.5	47.4	65.6	4

6件套公制精抛光双梅花扳手

6 Pc Double Ring End Spanner Set

- 采用优质铬钒钢
- 表面镀铬, 镜抛处理
- Chrome-Vanadium steel
- Chrome plated, mirror polished

CR-V



Item no.	1
S017601	1
8x10, 11x13, 12x14, 17x19, 21x23, 22x24mm	

6件套公制精抛光双开口扳手

6 Pc Double Open End Spanner

- 采用优质铬钒钢
- 表面镀铬, 镜抛处理
- Chrome-Vanadium steel
- Chrome plated, mirror polished

CR-V



Item no.	1
S018101	1
6x7, 8x10, 11x13, 12x14, 17x19, 21x23mm	

11件套公制精抛光双梅花扳手

11 Pc Double Ring End Spanner Set

- 采用优质铬钒钢
- 表面镀铬, 镜抛处理
- Chrome-Vanadium steel
- Chrome plated, mirror polished

CR-V



Item no.	1
S017602	1
8x10, 10x12, 11x13, 12x14, 14x17, 17x19, 19x21, 21x23, 22x24, 23x26, 24x27mm	

13件套公制精抛光双开口扳手

13 Pc Double Open End Spanner

- 采用优质铬钒钢
- 表面镀铬, 镜抛处理
- Chrome-Vanadium steel
- Chrome plated, mirror polished

CR-V



Item no.	1
S018102	1
6x7, 8x10, 10x12, 11x13, 12x14, 14x17, 17x19, 19x21, 21x23, 22x24, 23x26, 24x27, 30x32mm	

公制精抛光大规格两用长扳手

Combination Wrench

- 采用优质钢材
- 表面镀铬, 镜抛处理
- Forged from high-grade alloy steel
- Chrome plated, mirror polished

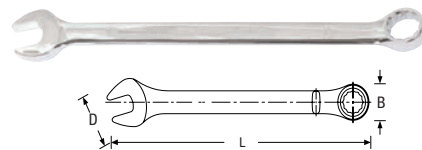

Item no.	Size (mm)	L (mm)	B (mm)	D (mm)	T (mm)
S017134	34	460	50.5	68.7	4
S017135	35	460	50.5	68.7	4
S017136	36	513	56.3	75	4
S017138	38	513	56.3	75	4
S017141	41	564	63.5	87.9	4
S017146	46	564	63.5	87.9	2
S017150	50	598	74	96	2
S017156	55	620	82	105	2
S017160	60	660	90	115	2
S017165	65	680	124.8	97.3	2

欧式凹筋两用扳手
Combination Wrench

- 采用优质钢材锻造, 整体热处理加工
- 欧式凹筋款式, 表面镀铬处理
- Forged from high-grade alloy steel, heat-treated
- European ribbed style, chrome plated for rust-resistant

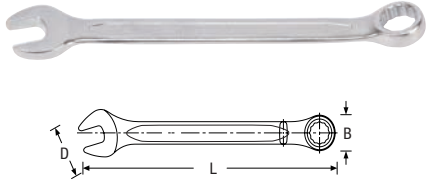

Item no.	Size (mm)	L (mm)	B (mm)	D (mm)	
S017306	6	101	12	14.5	12
S017307	7	111	13	16.5	12
S017308	8	121	14.2	17.5	12
S017309	9	131	15.5	19	12
S017310	10	141	16.8	21	12
S017311	11	152	18	23	12
S017312	12	161	19.2	25	12
S017313	13	172	20.5	27	12
S017314	14	183	22.2	29.5	12
S017315	15	191	23.5	31.5	12
S017316	16	201	25	33	12
S017317	17	211	26.5	35	12
S017318	18	221	27.8	37.4	12
S017319	19	231	29.5	39	12
S017320	20	242	30.6	41	12
S017321	21	253	32	43	6
S017322	22	262	33.5	44.5	6
S017323	23	275	34.8	46.5	6
S017324	24	287	36.5	48.5	6
S017325	25	300	37.5	50.5	6
S017327	27	331	39	54.5	6
S017330	30	384	43.5	60.5	4
S017332	32	405	46.5	63.5	4

公制精抛光双梅花扳手
Double Ring End Spanner

- 采用优质铬钒钢
- 表面镀铬, 镜抛处理
- Chrome-Vanadium steel
- Chrome plated, mirror polished

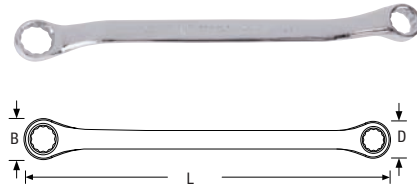
CR-V

Item no.	Size	L (mm)	B (mm)	D (mm)	
S017606	6x7	173	14.3	15.9	12
S017608	8x10	173	14.3	15.9	12
S017610	10x12	191	15.7	18.1	12
S017611	11x13	211	18.1	20.5	12
S017612	12x14	233	20.5	23.4	12
S017613	13x15	235	23.6	22.2	12
S017614	14x17	244	23.4	27.7	12
S017616	16x18	245	24.8	27.7	12
S017617	17x19	264	27.7	28.7	12
S017619	19x21	292	28.7	33.6	6
S017620	19x22	292	28.7	33.6	6
S017621	21x23	298	30.7	33.6	6
S017622	22x24	323	33.6	35.3	6
S017623	23x26	342	35.3	37	6
S017624	24x27	342	35.3	37	6
S017627	27x30	390	38.9	42.8	6
S017630	30x32	390	44.6	47.9	6
S017632	32x36	420	46.7	51.8	4
S017634	34x36	420	46.7	51.8	4
S017636	36x41	462	52.9	58.2	4

英制精抛光两用扳手
Combination Wrench

- 采用优质铬钒钢整体锻造加工
- 表面镀铬, 镜抛处理
- Forged from high-grade chrome-vanadium steel, heat-treated
- Chrome plated, mirror polished

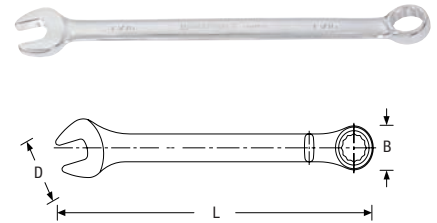
CR-V

Item no.	Size (mm)	L (mm)	B (mm)	D (mm)	
S017406	1/4"	128	11	14	12
S017407	5/16"	148.3	13.9	17.6	12
S017408	3/8"	167.3	16.2	22	12
S017409	7/16"	186.3	17.9	24.1	12
S017410	1/2"	196.4	19.1	25.9	12
S017411	9/16"	223.4	22.3	30.6	12
S017412	5/8"	243.4	24.7	33.7	12
S017413	11/16"	262.4	26.9	36.6	12
S017414	3/4"	281.4	29.2	40.2	12
S017415	13/16"	301.4	31.8	43.2	12
S017416	7/8"	319.4	34.3	46.5	6
S017417	15/16"	339.4	36	49.7	6
S017418	1"	358.4	37	52.9	6
S017419	1-1/16"	388.4	40.5	56.1	6
S017420	1-1/8"	404.5	42.8	59.2	4
S017421	1-1/4"	431.5	47.4	65.6	4

全抛光套筒开口扳手
Fully polished socket open wrench

- 采用优质铬钒钢整体锻造加工
- 表面镀铬, 镜抛处理
- Forged from high-grade chrome-vanadium steel, heat-treated
- Chrome plated, mirror polished

CR-V

Item no.	Size(mm)	L(mm)	
S017213	13	207	12



专利型齿套防滑两用扳手 Combination Wrench

- 优质CR-V合金钢锻造，整体热处理加工，表面镀铬处理，超长寿命使用
- 专利齿套设计梅花端，可轻松拆卸六角，十二角，五角，花型，四角，英制螺栓
- 开口端独特防滑槽设计，增强摩擦力，有效防止拆卸过程中的打滑和脱落。
- 薄型设计，较小头部轮廓，节省使用空间，便于狭小空间作业。
- Made by heat-treated Chrome Vanadium Steel, chrome plated, superior life-time test
- Spline ratchet head with national utility patent, easy for use on hexagonal, square-headed bolt and nuts and other aircraft bolt
- Non-slip open end designing get better nut friction and better slippery prevent
- Thinner design, smaller head profile, light weight and convenient using, suitable for limited space

专利型齿套防滑两用扳手

Combination Wrench With Patent

- 采用优质铬钒钢整体锻造加工
- 表面镀铬，镜抛处理
- Forged from high-grade chrome-vanadium steel, heat-treated
- Chrome plated, mirror polished

CR-V

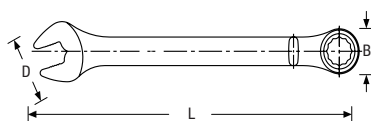

公制精抛光双开口扳手

Double Open End Spanner

- 采用优质铬钒钢
- 表面镀铬，镜抛处理
- Chrome-Vanadium steel
- Chrome plated, mirror polished

CR-V

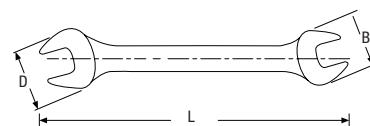

Item no.	Size (mm)	L (mm)	B (mm)	D (mm)	
S018106	6x7	108.2	14.4	17.3	12
S018107	7x9	128.2	17.7	19.8	12
S018108	8x10	128.2	17.7	19.8	12
S018110	10x12	133	21.1	24.4	12
S018111	11x13	146.2	24.8	27.8	12
S018112	12x14	156.8	27.8	31.1	12
S018113	13x15	179	31.1	34.4	12
S018114	14x17	179	31.1	34.4	12
S018115	13x16	179	31.1	34.4	12
S018116	16x18	198.1	34.4	37.8	12
S018117	17x19	221.9	37.8	41.1	12
S018119	19x21	237.7	41.1	47.8	6
S018120	19x22	237.7	41.1	47.8	6
S018121	21x23	253.2	44.4	47.8	6
S018122	22x24	253.2	44.4	47.8	6
S018123	23x26	271.9	51.1	52.8	6
S018124	24x27	292.7	49.9	51.9	6
S018127	27x30	290.8	62.7	56.4	6
S018130	30x32	338	56.4	66.7	4
S018132	32x36	284	64.7	69.5	4
S018134	34x36	284	64.3	69.3	4
S018135	30x34	284	64.7	69.5	4
S018136	36x41	321	70	82	4
S018141	41x46	371	82	92	4

Item no.	Size (mm)	L (mm)	B (mm)	D (mm)	
S017507	7	129	7.8	16.3	6
S017508	8	136	8.5	18.2	6
S017510	10	160	17.5	22.5	6
S017512	12	172	19.4	25.9	6
S017513	13	177	20.6	26.9	6
S017514	14	189	22.5	30.7	6
S017516	16	205	24.9	34.1	6
S017517	17	226	26.9	37.6	6
S017518	18	238	28.3	39.1	6
S017519	19	249	30.1	40.6	6



开口端独特防滑槽设计，增强摩擦力，有效防止拆卸过程中的打滑和脱落。

Non-slip open end designing get better nut friction and better slippery prevent



专利齿套设计梅花端，可轻松拆卸六角，十二角，五角，花型，四角，英制螺栓

Spline ratchet head with national utility patent, easy for use on hexagonal, square-headed bolt and nuts and other aircraft bolt

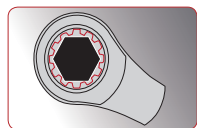

六角

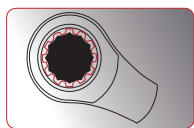

十二角

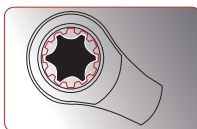

花型

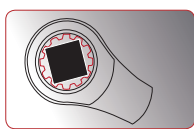

方形



棘轮快扳 Ratchet Wrench

- 采用进口材质精加工成型工艺，精抛光表面。
- 先进72齿棘轮结构，最小转动角度5°，使工作更迅速简便。
- 独特的超薄设计，适合于狭窄空间作业。加长手柄更易施力。
- 精准的棘轮机构，工作安全舒适。
- 镀镍铬表面，防锈耐腐蚀。
- 活头可多角度转动。
- Flex-Head pivots 90 degrees in either direction for access in tight areas
- 72-teeth design for extra strength
- High-polished chrome finish cleans easily. Long beam provide extra turning power
- Ratcheting box-end needs as little as 5-Degree to move fastener VS. 30-Degree for standard box end wrenches
- **活头棘开两用快扳**
Flexible Ratchet Combination Wrench



- **双向棘轮快扳**
Reversible Ratchet Combination Wrench



先进72齿棘轮结构，最小转动角度5°，使工作更迅速简便。

72 Fine tooth design for extra strength, ratcheting box-end needs as little as 5-Degree to move fastener

- **双梅花棘轮快扳**
Double Box End Reversible Ratchet Wrench



独特的超薄设计，适合于狭窄空间作业。
Slim Ratcheting box-end for access in tight areas

8件套公制精抛光棘开两用长快扳组套

8 Pc Ratchet Combination Wrench Set

- 采用优质铬钒钢
- 72齿双向棘轮
- 表面镀铬，镜面抛光处理
- Chrome-Vanadium steel
- 72-Teeth reversible ratcheting Gear
- Chrome plated, mirror polished

CR-V

Item no.

S018601

1

8, 10, 12, 13, 14, 16, 17, 19mm

12件套公制精抛光棘开两用长快扳组套

12 Pc Ratchet Combination Wrench Set

- 采用优质铬钒钢
- 72齿双向棘轮
- 表面镀铬，镜面抛光处理
- Chrome-Vanadium steel
- 72-teeth reversible ratcheting Gear
- Chrome plated, mirror polished

CR-V

Item no.

S018602

1

8, 9, 10, 11, 12, 13, 14, 15, 16, 17, 18, 19mm

5件套公制精抛光双梅花棘轮快扳组套

5 Pc Double Box End Reversible Ratchet Wrench Set

- 采用优质铬钒钢
- 72齿双向棘轮
- 表面镀铬，镜面抛光处理
- Chrome-Vanadium steel
- 72-Teeth reversible ratcheting Gear
- Chrome plated, mirror polished

CR-V

Item no.

S018901

1

8X10mm, 12X13mm, 14X15mm, 16X18mm, 17X19mm

7件套公制精抛光活头棘开快扳组套

7 Pc Flexible Ratchet Combination Wrench Set

- 采用优质铬钒钢
- 72齿双向棘轮
- 表面镀铬，镜面抛光处理
- Chrome-Vanadium steel
- 72-teeth reversible ratcheting Gear
- Chrome plated, mirror polished

CR-V

Item no.

S018902

1

10, 12, 13, 14, 16, 17, 19mm

公制油管扳手

Flare Nut Wrench

- 采用优质铬钒钢
- 表面镀铬，镜抛处理
- Chrome-Vanadium steel
- Chrome plated, mirror polished

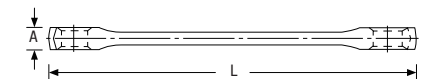
CR-V

Item no.

S019108

 Size
(mm)

 L
(mm)

 A
(mm)

12

S019109

9x11

152.4

7.9

12

S019110

10x12

152.4

7.9

12

S019113

13x14

178.6

10

12

公制精抛光棘开两用长快扳

Ratchet Combination Wrench

- 采用优质铬钒钢
- 72齿棘轮
- 表面镀铬, 镜抛处理
- Chrome-Vanadium steel
- 72-teeth ratcheting gear
- Chrome plated, mirror polished

CR-V

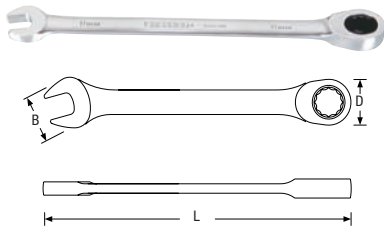

Item no.	Size (mm)	L (mm)	B (mm)	D (mm)	
S018608	8	136	18.0	17.5	6
S018609	9	143	20.0	19.3	6
S018610	10	143	20.0	19.3	6
S018611	11	168	24.5	22.7	6
S018612	12	174	26.3	24.0	6
S018613	13	180	27.6	26.0	6
S018614	14	193	31.4	27.7	6
S018615	15	200	33.4	29.0	6
S018616	16	216	34.6	30.7	6
S018617	17	233	38.4	33.0	6
S018618	18	239	39.9	33.0	6
S018619	19	250	41.5	34.8	6
S018621	21	285	45.8	42.0	6
S018622	22	285	45.8	42.0	6
S018624	24	325	51.5	47.5	6
S018627	27	359	55.2	52.0	6
S018630	30	425	65.0	60.0	4
S018632	32	425	65.0	60.0	4

公制精抛光双向棘开两用快扳

Reversible Ratchet Combination Wrench

- 采用优质铬钒钢
- 72齿棘轮
- 表面镀铬, 镜抛处理
- Chrome-Vanadium steel
- 72-teeth reversible ratcheting gear
- Chrome plated, mirror polished

CR-V

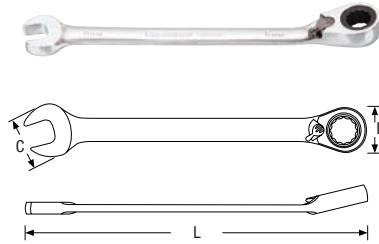

Item no.	Size (mm)	L (mm)	C (mm)	D (mm)	
S018808	8	140	16.7	16.6	6
S018810	10	159	20.8	20.0	6
S018812	12	173	27.1	24.5	6
S018813	13	178	27.1	24.7	6
S018814	14	191	29.2	27.0	6
S018816	16	208	33.4	30.0	6
S018817	17	226	35.5	31.8	6
S018818	18	237	37.6	32.6	6
S018819	19	248	39.7	33.8	6
S018821	21	290	46.0	40.0	6
S018822	22	290	46.0	40.0	6
S018824	24	323	52.2	46.0	6
S018827	27	359	56.5	52.5	6
S018830	30	403	62.7	58.5	4
S018832	32	425	66.4	62.5	4

公制尖尾棘轮扳手

Construction Ratchet Wrench

- 采用优质铬钒钢
- 36齿棘轮
- 表面防眩目磷化发黑处理
- Chrome-Vanadium steel
- 36-teeth ratcheting gear
- Black phosphated surface anti-dazzling

CR-V

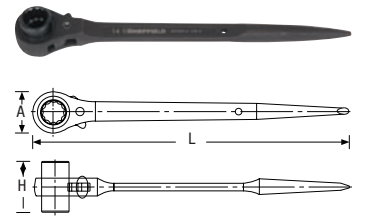

Item no.	Size(mm)	L(mm)	A(mm)	H(mm)	
S019310	10x12	225	28.2	40	2
S019312	12x14	225	28.2	40	2
S019314	14x17	267	34	45	2
S019317	17x19	309.5	40.7	50	2
S019319	19x22	309.5	40.7	50	2
S019322	22x24	365	52	56	2
S019324	24x27	365	52	56	2
S019330	30x32	365	52	56	2
S019326	21x26	365	52	56	2
S019332	32x36	420	75	56	2
S019336	36x41	420	75	56	2

公制精抛光双梅花快扳

Double Box End Reversible Ratchet Wrench

- 采用优质铬钒钢
- 72齿双向棘轮
- 表面镀铬, 镜抛处理
- Chrome-Vanadium steel
- 72-teeth reversible ratcheting gear
- Chrome plated, mirror polished

CR-V

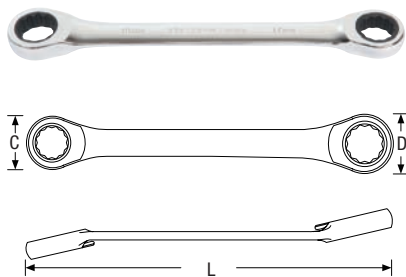

Item no.	Size (mm)	L (mm)	C (mm)	D (mm)	
S019008	8x10	128	16.8	20.2	6
S019012	12x13	170	23.0	24.8	6
S019014	14x15	190	26.5	29.5	6
S019016	16x18	210	29.5	33.5	6
S019017	17x19	230	31.5	33.5	6

公制精抛光活头棘开两用快扳

Flexible Ratchet Combination Wrench

- 采用优质铬钒钢
- 72齿棘轮
- 表面镀铬, 镜抛处理
- Chrome-Vanadium steel
- 72-teeth reversible ratcheting gear
- Chrome plated, mirror polished

CR-V

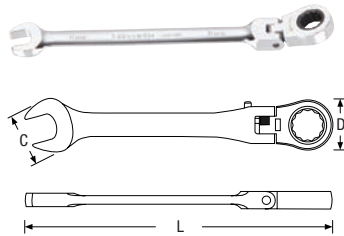

Item no.	Size (mm)	L (mm)	C (mm)	D (mm)	
S018908	8	127	16.2	16.7	6
S018909	9	131.5	18.2	18.6	6
S018910	10	136	20.3	20.0	6
S018911	11	141	22.5	21.8	6
S018912	12	147.5	24.3	23.0	6
S018913	13	154	26.8	25.2	6
S018914	14	160	28.7	26.8	6
S018915	15	169	30.5	28.3	6
S018916	16	179	32.9	29.8	6
S018917	17	190	34.5	31.8	6
S018918	18	203	37.0	32.8	6
S018919	19	215	39.2	33.9	6

重型开口敲击扳手

Open End Slogging Wrench

- 优质铬钒钢整体锻造
- 表面喷砂, 特殊抗氧化处理
- Forged from Chrome-Vanadium alloy steel
- Satin finish for corrosion protection

CR-V

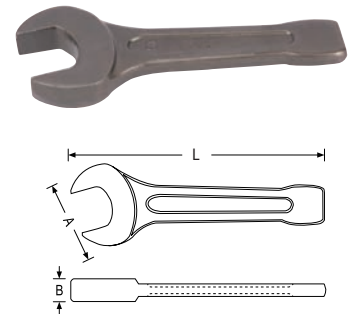

Item no.	Size(mm)	A(mm)	B(mm)	L(mm)	N.W(kg)	
S019501	30	62.3	17	190	0.53	1
S019502	32	66.5	17	190	0.63	1
S019503	36	74.8	18	210	0.674	1
S019504	41	85.2	19	230	1.04	1
S019505	46	95.5	21	250	1.224	1
S019506	50	80	22	275	1.79	1
S019507	55	86	24	302	2.36	1
S019508	60	93	26	315	2.85	1
S019509	65	102	28	336	3.25	1
S019510	70	110	30	367	4	1
S019511	75	110	32	384	4.78	1
S019512	80	174	34	408	6.82	1
S019513	85	174	34	408	7.3	1
S019514	90	194	38	445	8.27	1
S019515	95	194	38	445	9.7	1
S019516	100	215	44	485	10.5	1
S019517	105	215	44	485	11.3	1

重型梅花敲击扳手

Ring Slogging Wrench

- 优质铬钒钢整体锻造
- 表面喷砂, 特殊抗氧化处理
- Forged from Chrome-Vanadium alloy steel
- Satin finish for corrosion protection

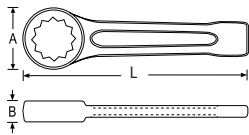
CR-V

Item no.	Size(mm)	A(mm)	B(mm)	L(mm)	N.W(kg)	
S019521	27	46	16	180	0.34	1
S019522	30	52	17	190	0.435	1
S019523	32	52	17	190	0.515	1
S019524	36	58	20	205	0.56	1
S019525	41	66	20	230	0.68	1
S019526	46	74	22	240	0.895	1
S019527	50	80	24	255	1.125	1
S019528	55	86	25	270	1.33	1
S019529	60	93	26	280	1.545	1
S019530	65	102	30	300	1.875	1
S019531	70	110	33	330	2.365	1
S019532	75	110	33	330	2.735	1
S019533	80	126	36	360	3.675	1
S019534	85	126	36	360	3.71	1
S019535	90	142	40	390	5.85	1
S019536	95	142	40	390	5.85	1
S019537	100	155	45	420	6.445	1
S019538	105	155	45	420	6.55	1
S019539	110	170	48	450	8	1
S019540	115	170	48	450	8.3	1
S019541	120	182	54	480	9	1

单头开口扳手

Open Jaw Spanner

- 优质铬钒钢整体锻造
- 表面喷砂, 特殊抗氧化处理
- Forged from Chrome-Vanadium alloy steel
- Satin finish for corrosion protection

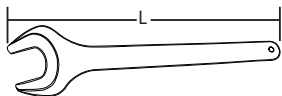
CR-V

Item no.	Size(mm)	L(mm)	N.W(kg)	
S019554	30	267	0.285	1
S019555	32	285	0.33	1
S019556	34	300	0.395	1
S019557	36	317	0.428	1
S019558	41	345	0.545	1
S019559	46	375	0.8	1
S019560	50	410	0.98	1
S019561	55	455	1.26	1
S019562	60	490	1.65	1
S019563	65	575	1.895	1
S019564	70	608	2.34	1

扭力扳手

Torque Wrench

- 精密钢材整体锻造, 精抛磨光加工, 表面镀铬处理, 光亮且耐腐蚀。
- 双色耐油手柄, 符合人体工学设计, 安全舒适耐用。
- 双视窗刻度盘, 三种刻度值显示, 操作简单, 示值精确。
- 双向45齿棘轮设计, 适合狭小空间, 顺向及逆向操作。
- 输出扭矩精度 $\pm 3\%$, 符合国际标准。
- Fast, accurate and easy to use torque wrenches have accuracy $\pm 3\%$
- Reversible ratchet head features a 45-teeth ratchet design requiring only 8 degrees of hand travel for indexing.
- English and metric markings are color coded for easy reading.
- Ball bearing-mounted internal torque control mechanism provides proper lubrication, high accuracy, prolonged calibration life and consistent results.
- Positive, spring-loaded locking mechanism automatically locks in the selected reading to prevent accidental change.

升级

双色耐油手柄, 双视窗刻度盘,

三种刻度值显示

Rubber dust seal at neck keeps dirt out of internal mechanism English and metric markings

 双向45齿棘轮设计, 适合狭小空间, 顺向及逆向操作
45-teeth reversible ratchet

 全钢结构手柄, 滚花设计
精确滚花双刻度, 推拉式结构

 Knurled handle for tough, non-slip grip
Special locking mechanism for greatest accuracy, longer calibration

- 精密钢材整体锻造, 精抛磨光加工, 表面镀铬处理, 光亮且耐腐蚀。
- 全钢结构手柄, 滚花设计, 防滑坚固耐用。
- 精确滚花双刻度, 推拉式结构, 设定扭力值, 操作简单, 准确。
- 双向45齿棘轮设计, 适合狭小空间, 顺向及逆向操作。
- 输出扭矩精度 $\pm 3\%$, 符合国际标准。
- Drop forged, heat treated chrome vanadium steel head
- New pull-and-push locking mechanism for greatest accuracy, longer calibration
- Chrome plated alloy steel construction
- Knurled handle for sure grip
- 45-teeth reversible ratchet
- Accuracy within $\pm 3\%$, international standard
- Dual reading scale

6.3mm系列专业级可调式扭力扳手

Torque Wrench

- 棘轮头采用Cr-Mo锻造, 经热处理
- 双色耐油手柄, 符合人体工学设计, 安全舒适耐用
- 精度 $\pm 3\%$
- 45齿双向可调棘轮
- 手柄尾端调整锁紧装置
- 公英制扭力刻度
- Drop forged, heat treated Cr-Mo steel head
- Accuracy within $\pm 3\%$
- 45-teeth reversible ratchet
- Rear locking mechanism for greatest accuracy, longer calibration
- Dual reading scale

CR-MO 升级

Item no.	Drive	N.m	L(mm)	W.T(kg)	
S016101	1/4"	2.5-12	275	0.54	1
S016102	1/4"	4-20	275	0.54	1

10mm系列专业级可调式扭力扳手

Torque Wrench

- 棘轮头采用Cr-Mo锻造, 经热处理
- 双色耐油手柄, 符合人体工学设计, 安全舒适耐用
- 精度 $\pm 3\%$
- 45齿双向可调棘轮
- 手柄尾端调整锁紧装置
- 公英制扭力刻度
- Drop forged, heat treated Cr-Mo steel head
- Accuracy within $\pm 3\%$
- 45-teeth reversible ratchet
- Rear locking mechanism for greatest accuracy, longer calibration
- Dual reading scale

CR-MO 升级

Item no.	Drive	N.m	L(mm)	W.T(kg)	
S016103	3/8"	6-30	310	0.68	1
S016104	3/8"	10-60	360	0.82	1
S016105	3/8"	25-125	420	0.90	1

12.5mm系列专业级可调式扭力扳手

Torque Wrench

- 棘轮头采用Cr-Mo锻造, 经热处理
- 双色耐油手柄, 符合人体工学设计, 安全舒适耐用
- 精度 $\pm 3\%$
- 45齿双向可调棘轮
- 手柄尾端调整锁紧装置
- 公英制扭力刻度
- Drop forged, heat treated Cr-Mo steel head
- Accuracy within $\pm 3\%$
- 45-teeth reversible ratchet
- Rear locking mechanism for greatest accuracy, longer calibration
- Dual reading scale

CR-MO 升级

Item no.	Drive	N.m	L(mm)	W.T(kg)	
S016106	1/2"	40-200	460	1.02	1
S016107	1/2"	60-340	520	1.16	1

19mm系列专业级可调式扭力扳手

Torque Wrench

- 棘轮头采用Cr - Mo锻造, 经热处理
- 双色耐油手柄, 符合人体工程学设计, 安全舒适耐用
- 精度 ± 3%
- 45齿双向可调棘轮
- 手柄尾端调整锁紧装置
- 公英制扭力刻度
- Drop forged, heat treated Cr-Mo steel head
- Accuracy within +/-3%
- 45-teeth reversible ratchet
- Rear locking mechanism for greatest accuracy, longer calibration
- Dual reading scale

CR-MO 升级



Item no.	Drive	N.m	L(mm)	W.T(kg)	
S016108	3/4"	100-500	840	4.04	1
S016109	3/4"	160-800	1040	4.93	1
S016110	3/4"	200-1000	1040	4.93	1

10mm系列全钢型预制式工业级扭力扳手

Torque Wrench

- 棘轮头采用Cr - Mo锻造, 经热处理
- 全钢结构, 表面镀铬
- 精度 ± 3%, 优于国际上扭力扳手的标准精度
- 45齿双向可调棘轮
- 采用最新拉推定位式锁紧机构
- 公英制扭力刻度
- 滚花手柄, 握持更可靠
- Drop forged, heat treated Cr-Mo steel head
- Chrome plated alloy steel construction
- Accuracy within +/-3%
- 45-teeth reversible ratchet
- New pull-and-push locking mechanism for greatest accuracy, longer calibration
- Dual reading scale
- Knurled handle for sure grip

CR-MO



Item no.	Drive	N.m	L(mm)	W.T(kg)	
S016122	3/8"	4.5-30	315	0.82	1
S016123	3/8"	10-60	365	0.96	1
S016124	3/8"	25-125	425	1.04	1

19mm系列全钢型预制式工业级扭力扳手

Torque Wrench

- 棘轮头采用Cr - Mo锻造, 经热处理
- 全钢结构, 表面镀铬
- 精度 ± 4%, 优于国际上扭力扳手的标准精度
- 45齿双向可调棘轮
- 采用最新拉推定位式锁紧机构
- 公英制扭力刻度
- 滚花手柄, 握持更可靠
- Drop forged, heat treated Cr-Mo steel head
- Chrome plated alloy steel construction
- Accuracy within +/-4%
- 45-teeth reversible ratchet
- New pull-and-push locking mechanism for greatest accuracy, longer calibration
- Dual reading scale
- Knurled handle for sure grip

CR-MO



Item no.	Drive	N.m	L(mm)	W.T(kg)	
S016127	3/4"	160-800	1055	5.90	1
S016128	3/4"	200-1000	1055	5.90	1

6.3mm系列全钢型预制式工业级扭力扳手

Torque Wrench

- 棘轮头采用Cr - Mo锻造, 经热处理
- 全钢结构, 表面镀铬
- 精度 ± 3%, 优于国际上扭力扳手的标准精度
- 45齿双向可调棘轮
- 采用最新拉推定位式锁紧机构
- 公英制扭力刻度
- 滚花手柄, 握持更可靠
- Drop forged, heat treated Cr-Mo steel head
- Chrome plated alloy steel construction
- Accuracy within +/-3%
- 45-teeth reversible ratchet
- New pull-and-push locking mechanism for greatest accuracy, longer calibration
- Dual reading scale
- Knurled handle for sure grip

CR-MO



Item no.	Drive	N.m	L(mm)	W.T(kg)	
S016120	1/4"	2.5-12	280	0.68	1
S016121	1/4"	4-20	280	0.68	1

12.5mm系列全钢型预制式工业级扭力扳手

Torque Wrench

- 棘轮头采用Cr - Mo锻造, 经热处理
- 全钢结构, 表面镀铬
- 精度 ± 3%, 优于国际上扭力扳手的标准精度
- 45齿双向可调棘轮
- 采用最新拉推定位式锁紧机构
- 公英制扭力刻度
- 滚花手柄, 握持更可靠
- Drop forged, heat treated Cr-Mo steel head
- Chrome plated alloy steel construction
- Accuracy within +/-3%
- 45-teeth reversible ratchet
- New pull-and-push locking mechanism for greatest accuracy, longer calibration
- Dual reading scale
- Knurled handle for sure grip

CR-MO



Item no.	Drive	N.m	L(mm)	W.T(kg)	
S016125	1/2"	40-200	465	1.16	1
S016126	1/2"	65-335	525	1.30	1

9X12mm专业级可调式换头扭力扳手

Torque Wrench

- 方孔可换结构设计, 可轻松配备9X12mm棘轮扳手, 开口, 梅花插件使用
- 采用Cr - Mo锻造, 整体热处理
- 双色耐油手柄, 握感舒适
- ± 3%精度误差
- Square adapter head, for use with removable accessories
- Such as open end and ring end, or with ratchets
- Drop forged & heat treated, Cr-Mo steel
- Chrome plated alloy steel construction with non-slip grip handle
- Double scale window, easy to setup
- Accurate within +/-3%

CR-MO 升级



Item no.	Drive	N.m	L(mm)	W.T(kg)	
S016301	9X12mm	2.5-12	260	0.54	1
S016302	9X12mm	4-20	260	0.54	1
S016303	9X12mm	6-30	295	0.68	1
S016304	9X12mm	10-60	345	0.82	1
S016305	9X12mm	25-125	405	0.90	1

14X18mm专业级可调式换头扭力扳手
Torque Wrench

- 方孔可换结构设计,可轻松配备14X18mm棘轮扳手,开口,梅花插件使用
- 采用Cr-Mo锻造,整体热处理
- 双色耐油手柄,握感舒适
- ±3%精度误差
- Square adapter head, for use with removable accessories
- Such as open end and ring end, or with ratchets
- Drop forged & heat treated, Cr-Mo steel
- Chrome plated alloy steel construction with non-slip grip handle
- Double scale window, easy to setup
- Accurate within +/-3%

CR-MO 升级

Item no.	Drive	N.m	L(mm)	W.T(kg)	
S016306	14X18mm	40-200	455	1.02	1
S016307	14X18mm	60-340	515	1.16	1

9X12mm全钢制可调式换头扭力扳手
Torque Wrench

- 方孔可换结构设计,可轻松配备9X12mm棘轮扳手,开口,梅花插件使用
- 采用Cr-Mo锻造,整体热处理
- 整体全钢制造,特殊滚花手柄,舒适防滑耐用
- ±3%精度误差
- Square adapter head, for use with removable accessories
- Such as open end and ring end, or with ratchets
- Drop forged & heat treated, Cr-Mo steel
- Chrome plated alloy steel construction with non-slip grip handle
- Double scale window, easy to setup
- Accurate within +/-3%

CR-MO

Item no.	Drive	N.m	L(mm)	W.T(kg)	
S016311	9X12mm	2.5-12	300	0.68	1
S016312	9X12mm	4.0-20	300	0.68	1
S016313	9X12mm	4.5-30	300	0.82	1
S016314	9X12mm	10-60	350	0.96	1
S016315	9X12mm	25-125	410	1.04	1

24X32mm全钢制可调式换头扭力扳手
Torque Wrench

- 方孔可换结构设计,可轻松配备24X32mm棘轮扳手,开口,梅花插件使用
- 采用Cr-Mo锻造,整体热处理
- 整体全钢制造,特殊滚花手柄,舒适防滑耐用
- ±4%精度误差
- Square adapter head, for use with removable accessories
- Such as open end and ring end, or with ratchets
- Drop forged & heat treated, Cr-Mo steel
- Chrome plated alloy steel construction with non-slip grip handle
- Double scale window, easy to setup
- Accurate within +/-4%

CR-MO

Item no.	Drive	N.m	L(mm)	W.T(kg)	
S016318	24X32mm	100-500	1250	5.9	1
S016319	24X32mm	160-800	1250	5.9	1
S016320	24X32mm	200-1000	1250	5.9	1

24X32mm专业级可调式换头扭力扳手
Torque Wrench

- 方孔可换结构设计,可轻松配备24X32mm棘轮扳手,开口,梅花插件使用
- 采用Cr-Mo锻造,整体热处理
- 双色耐油手柄,握感舒适
- ±4%精度误差
- Square adapter head, for use with removable accessories
- Such as open end and ring end, or with ratchets
- Drop forged & heat treated, Cr-Mo steel
- Chrome plated alloy steel construction with non-slip grip handle
- Double scale window, easy to setup
- Accurate within +/-4%

CR-MO 升级

Item no.	Drive	N.m	L(mm)	W.T(kg)	
S016308	24X32mm	100-500	850	4.04	1
S016309	24X32mm	160-800	1050	4.93	1
S016310	24X32mm	200-1000	1050	4.93	1

14X18mm全钢制可调式换头扭力扳手
Torque Wrench

- 方孔可换结构设计,可轻松配备14X18mm棘轮扳手,开口,梅花插件使用
- 采用Cr-Mo锻造,整体热处理
- 整体全钢制造,特殊滚花手柄,舒适防滑耐用
- ±3%精度误差
- Square adapter head, for use with removable accessories
- Such as open end and ring end, or with ratchets
- Drop forged & heat treated, Cr-Mo steel
- Chrome plated alloy steel construction with non-slip grip handle
- Double scale window, easy to setup
- Accurate within +/-3%

CR-MO

Item no.	Drive	N.m	L(mm)	W.T(kg)	
S016316	14X18mm	40-200	460	1.16	1
S016317	14X18mm	65-335	520	1.3	1

全钢型重型预置式扭力扳手
Torque Wrench

- 50齿双向可调棘轮头,扁平扳体设计,最小7°操作
- 棘轮头和扳体采用Cr-Mo锻造,经热处理,扭力载荷高
- 精度±3%,优于国际扭力扳手的标准精度
- 全新推拉式定位锁紧结构
- 全封闭结构,防止污物进入
- 50-teeth reversible ratchet, flat spanner body, minimum 7 degrees operation
- Drop forged, heat treated chrome molybdenum steel head and body, high torque load
- Accurate within +/-3%
- New push-and-pull locking mechanism for greatest accuracy Full closed structure

CR-MO

Item no.	Drive	N.m	L(mm)	W.T(kg)	
S016131	1/4"	1-5N.m	240	0.34	1
S016132	3/8"	5-25N.m	275	0.42	1
S016133	3/8"	10-50N.m	275	0.42	1
S016134	1/2"	20-100N.m	380	0.58	1
S016135	1/2"	40-200N.m	505	1.33	1
S016136	1/2"	60-300N.m	695	1.85	1
S016137	3/4"	200-1000N.m	1200	8.6	1
S016138	3/4"	100-500N.m	950	6.3	1

表盘式扭力扳手

Dial Torque Wrench

- 双色PP+TPR手柄, 握持舒适
- 扳体整体采用合金钢材质加工
- 公英制双刻度扭力值表盘, 读数清晰
- 蓝色记忆指针, 保持峰值读数
- 使用过程中, 在20%~100%满量程范围内, 双向精度为±3%
- Bi-color PP + TPR, comfortable soft grip handle Alloy steel construction
- Dual reading scale for clear reading
- Blue memory pointer to maintain peak readings
- During use, under full scale range between 20%~100%, bi-directional accuracy is ± 3%

新品



Item no.	Drive	N.m	L(mm)	👉
S016141	1/4"	0-1.8N.m	254	1
S016142	1/4"	0-3.5N.m	254	1
S016143	1/4"	0-6N.m	254	1
S016144	1/4"	0-9N.m	254	1
S016145	3/8"	0-12N.m	254	1
S016146	3/8"	0-18N.m	254	1
S016147	3/8"	0-24N.m	254	1
S016148	3/8"	0-30N.m	254	1
S016149	3/8"	0-35N.m	254	1
S016150	3/8"	0-50N.m	378	1
S016151	3/8"	0-70N.m	378	1
S016152	1/2"	0-100N.m	546	1
S016153	1/2"	0-140N.m	546	1
S016154	1/2"	0-200N.m	546	1
S016155	1/2"	0-240N.m	546	1
S016156	1/2"	0-275N.m	546	1
S016157	1/2"	0-350N.m	546	1
S016158	3/4"	0-480N.m	708	1
S016159	3/4"	0-500N.m	708	1
S016160	3/4"	0-800N.m	1181	1
S016161	1"	0-1000N.m	1900	1
S016162	1"	0-1400N.m	1900	1
S016163	1"	0-2000N.m	2400	1
S016164	1"	0-2800N.m	3100	1
S016165	1"	0-3000N.m	3100	1

专业级可换向棘轮定值扭矩扳手

Preset Type Torque Wrench

- 棘轮头采用Cr-Mo锻造, 整体热处理
- 全钢结构, 表面镀铬
- 精度±3, 45齿双向可调棘轮
- 在扭力值范围内可按要求定制
- The ratchet head is forged by Cr-Mo, and the whole heat treatment
- All steel structure, surface chrome plating
- Precision + 45, 3 - way adjustable ratchet wheel
- In the range of torque value can be customized according to the requirements

CR-MO 新品

● 此产品为非常规库存产品, 需要一定的交货期



Item no.	Drive	N.m	L(mm)	W.T(kg)	👉
S016401	1/4"	2.5-12 N.m	260	3	1
S016402	1/4"	8-20 N.m	260	3	1
S016403	3/8"	10-30N.m	280	3	1
S016404	3/8"	20-60N.m	320	3	1
S016405	1"	20-60N.m	320	3	1
S016406	3/8"	50-125N.m	400	3	1
S016407	1"	50-125N.m	400	3	1
S016408	1/2"	80-200N.m	445	3	1
S016409	1/2"	120-335N.m	510	3	1
S016410	1/2"	120-335N.m	690	3	1
S016411	3/4"	200-500N.m	830	4	1
S016412	3/4"	300-800N.m	1030	4	1
S016413	1"	300-800N.m	1030	4	1
S016414	3/4"	400-1000N.m	1030	4	1
S016415	1"	400-1000N.m	1030	4	1
S016416	1"	600-1500N.m	1250	4	1
S016417	1"	800-2000Nm	1250	4	1
S016418	1"	1200-3000 Nm	1250	4	1

专业级可换向换头定值扭矩扳手

Torque Wrench

- 方孔可换结构设计, 可轻松配备棘轮扳手头、开口、梅花插件使用
- 全钢结构, 表面镀铬
- 在扭力值范围内可按要求定制, 精度±3
- 采用Cr-Mo锻造, 整体热处理
- Square hole can change the structure design, can be easily equipped with a ratchet wrench head, openings, plum blossom plug in use
- All steel structure, surface chrome plating
- In the range of torque value can be customized according to the requirements, the accuracy of 3
- Using Cr-Mo forging, the whole heat treatment

CR-MO 新品

● 此产品为非常规库存产品, 需要一定的交货期



Item no.	Drive(mm)	N.m	L(mm)	W.T(kg)	👉
S016431	9X12	2.5-12 N.m	245	3	1
S016432	9X12	8-20 N.m	245	3	1
S016433	9X12	10-30N.m	265	3	1
S016434	9X12	20-60N.m	305	3	1
S016435	9X12	50-125N.m	385	3	1
S016436	14X18	80-200N.m	440	3	1
S016437	14X18	120-335N.m	505	3	1
S016438	14X18	120-335N.m	685	3	1
S016439	24X32	200-500N.m	840	4	1
S016440	24X32	300-800N.m	1040	4	1
S016441	24X32	400-1000N.m	1040	4	1
S016442	24X32	600-1500N.m	1250	4	1
S016443	24X32	800-2000 Nm	1250	4	1
S016444	24X32	1200-3000 Nm	1250	4	1

数显扭力扳手 Torque Wrench

- 双向快速脱落棘轮头, 方便快捷
- 大屏幕LCD显示, 读数直观, 方便
- 蜂鸣、LED灯报警及独特振动报警设置, 适合高噪音环境使用
- 4种扭力单位设置: N.m/lbf-ft/lbf-in/Kgf-m, 可任意转换
- 误差精度±1%
- Double-end quick release ratchet head, fast and convenient
- LCD display, easy for reading
- Buzz, LED alarm and unique alarm equipment, suit for noise environment
- 4 types of torsion unit setting: N.m/lbf-ft/lbf-in/Kgf-m, easy to convert



双向快速脱落棘轮头, 方便快捷
Double-end quick release ratchet head, fast and convenient



蜂鸣、LED灯报警及独特振动报警设置, 适合高噪音环境使用
Buzz, LED alarm and unique alarm equipment, suit for noise environment

蜂鸣、LED灯报警及独特振动报警设置, 适合高噪音环境使用
Buzz, LED alarm and unique alarm equipment, suit for noise environment



双材料手柄, 耐油TPR+PP, 耐油、抗腐
Dual material handle, oil TPR + PP, urable, corrosion



Item no.	Drive	N.m	L(mm)	👉
S016201	3/8"	10-135N.m	390	1
S016202	1/2"	20-200N.m	565	1
S016203	1/2"	34-340N.m	765	1

扭力换算表 Torque Conversion Table

	Kgf.m	N.m	Lb.ft	Lb.Tn
Kgf.m	1	0.102	0.14	0.012
N.m	9.8	1	1.36	0.11
Lb.ft	7.23	0.74	1	0.08
Lb.Tn	86.72	8.85	12	1

使用提示

- 调整扭力值后, 需锁紧后再使用
- 请勿超过额定扭力
- 请勿用扳手敲击紧固件
- 使用完毕, 请将扭力值调至最小
- 扭力扳手需要定期校准以保证精度
- 定期检查、清洁和用轻质润滑油润滑棘轮机构

扭力倍增器

Torque Multipliers

- 合金钢制造, 使用寿命长
- 倍率传递准确率 ± 5%
- 齿轮采用优质合金钢特殊处理, 承受强度高
- 3.3倍的反作用力臂有两种, 可任意选用
- 5倍及25倍的反作用力臂可按工况条件调节受力圆柱的位置
- 1500N.m及以上的倍增器具有防回弹装置, 使用更安全
- Made of Alloy steel, long service life
- Specially treated alloy steel gear, with high-strength capacity
- Two types of reaction arm are available for 3.3:1 torque multipliers
- 5:1 or 25:1 reaction arm can be choosed by adjusting the position of Cylinder
- Anti wind up ratchet is available on the model with capacity 1500N.m and above

❗ 此产品为非常规库存产品, 需要一定的交货期



Item no.	Drive	N.m	L(mm)	
S016221	1/2"-3/4"	1000N.m	3.3:1	1
S016222	1/2"-3/4"	1000N.m	5:1	1
S016223	1/2"-1"	1500N.m	5:1	1
S016224	1/2"-1"	2500N.m	25:1	1
S016225	1/2"-1"	3000N.m	25:1	1
S016226	1/2"-1-1/2"	3500N.m	25:1	1
S016227	1/2"-1-1/2"	4000N.m	25:1	1
S016228	1/2"-1-1/2"	6000N.m	25:1	1
S016229	1/2"-1-1/2"	8000N.m	25:1	1

可换棘轮头插件

Ratchets

- 铬钒钢整体锻造, 坚固耐用
- 精密加工处理, 保证配合精度
- 45齿双向棘轮结构
- Durable drop forged chrome vanadium steel
- Micromachining to support better accuracy
- Forward/reverse gear with 45 tooth

❗ 此产品为非常规库存产品, 需要一定的交货期

CR-V



Item no.	Size	Drive	N.m	
S016501	1/4"	9x12mm	25	1
S016502	3/8"	9x12mm	160	1
S016503	1/2"	9x12mm	160	1
S016504	1/2"	14X18mm	420	1
S016505	3/4"	24X32mm	1200	1

方头开口插件

Open Ends

- 铬钒钢整体锻造, 坚固耐用
- 精密加工处理, 保证配合精度
- Durable drop forged chrome vanadium steel
- Micromachining to support better accuracy

❗ 此产品为非常规库存产品, 需要一定的交货期

CR-V



Item no.	Size	Drive	N.m	
S016507	7mm	9X12mm	9	1
S016508	8mm	9X12mm	13	1
S016509	9mm	9X12mm	18	1
S016510	10mm	9X12mm	24	1
S016511	11mm	9X12mm	32	1
S016512	12mm	9X12mm	41	1
S016513	13mm	9X12mm	51	1
S016514	14mm	9X12mm	63	1
S016515	15mm	9X12mm	77	1
S016516	16mm	9X12mm	92	1
S016517	17mm	9X12mm	109	1
S016518	18mm	9X12mm	125	1
S016519	19mm	9X12mm	145	1
S016520	20mm	9X12mm	160	1
S016521	21mm	9X12mm	160	1
S016522	22mm	9X12mm	160	1
S016524	24mm	9X12mm	160	1
S016563	25mm	9x12mm	160	1
S016526	27mm	9X12mm	160	1
S016527	28mm	9X12mm	160	1
S016564	30mm	9x12mm	160	1
S016528	32mm	9X12mm	160	1
S016565	36mm	9x12mm	160	1
S016566	41mm	9x12mm	160	1
S016567	8mm	14x18mm	13	1
S016568	9mm	14x18mm	18	1
S016569	10mm	14x18mm	24	1
S016570	11mm	14x18mm	32	1
S016571	12mm	14x18mm	41	1
S016572	13mm	14x18mm	51	1
S016573	14mm	14x18mm	63	1
S016574	15mm	14x18mm	77	1
S016575	16mm	14x18mm	92	1
S016576	17mm	14x18mm	109	1
S016577	18mm	14x18mm	125	1
S016535	19mm	14x18mm	145	1
S016578	20mm	14x18mm	160	1
S016536	21mm	14x18mm	190	1
S016537	22mm	14x18mm	220	1
S016538	24mm	14x18mm	280	1
S016539	25mm	14x18mm	320	1
S016540	27mm	14x18mm	360	1
S016581	28mm	14x18mm	360	1
S016582	29mm	14x18mm	360	1
S016541	30mm	14x18mm	360	1
S016542	32mm	14x18mm	360	1
S016543	34mm	14x18mm	360	1
S016544	36mm	14x18mm	360	1
S016583	38mm	14x18mm	360	1
S016584	39mm	14x18mm	360	1
S016545	41mm	14x18mm	360	1
S016585	45mm	14x18mm	360	1
S016546	46mm	14x18mm	360	1
S016586	49mm	14x18mm	360	1
S016547	50mm	14x18mm	360	1
S016588	52mm	14x18mm	360	1
S016589	55mm	14x18mm	360	1
S016590	57mm	14x18mm	360	1
S016591	60mm	14x18mm	360	1
S016593	65mm	14x18mm	360	1
S016595	70mm	14x18mm	360	1
S016597	75mm	14x18mm	360	1
S016598	90mm	14x18mm	360	1
S016599	19mm	24x32mm	1200	1
S016600	22mm	24x32mm	1200	1
S016601	24mm	24x32mm	1200	1
S016602	27mm	24x32mm	1200	1
S016603	28mm	24x32mm	1200	1
S016550	30mm	24x32mm	1200	1
S016551	32mm	24x32mm	1200	1
S016552	34mm	24x32mm	1200	1
S016553	36mm	24x32mm	1200	1
S016611	38mm	24x32mm	1200	1
S016554	41mm	24x32mm	1200	1
S016605	45mm	24x32mm	1200	1
S016555	46mm	24x32mm	1200	1
S016556	50mm	24x32mm	1200	1
S016557	55mm	24x32mm	1200	1
S016613	60mm	24x32mm	1200	1
S016607	65mm	24x32mm	1200	1
S016609	70mm	24x32mm	1200	1

方头梅花插件

Ring Ends

- 铬钒钢整体锻造, 坚固耐用
- 精密加工处理, 保证配合精度
- Durable drop forged chrome vanadium steel
- Micromachining to support better accuracy

❗ 此产品为非常规库存产品, 需要一定的交货期

CR-V



Item no.	Size	Drive	N.m	
S016560	7mm	9X12mm	25	1
S016330	8mm	9X12mm	34	1
S016345	9mm	9X12mm	45	1
S016331	10mm	9X12mm	58	1
S016332	11mm	9X12mm	72	1
S016333	12mm	9X12mm	89	1
S016334	13mm	9X12mm	105	1
S016335	14mm	9X12mm	125	1
S016336	15mm	9X12mm	145	1
S016337	16mm	9X12mm	160	1
S016338	17mm	9X12mm	160	1
S016339	18mm	9X12mm	160	1
S016340	19mm	9X12mm	160	1
S016342	21mm	9X12mm	160	1
S016343	22mm	9X12mm	160	1
S016365	10mm	14x18mm	58	1
S016366	12mm	14x18mm	89	1
S016375	13mm	14x18mm	105	1
S016376	14mm	14x18mm	125	1
S016377	15mm	14x18mm	150	1
S016378	16mm	14x18mm	175	1
S016379	17mm	14x18mm	200	1
S016380	18mm	14x18mm	230	1
S016350	19mm	14x18mm	260	1
S016381	20mm	14x18mm	290	1
S016352	21mm	14x18mm	330	1
S016353	22mm	14x18mm	360	1
S016354	24mm	14x18mm	360	1
S016356	27mm	14x18mm	360	1
S016382	28mm	14x18mm	360	1
S016358	30mm	14x18mm	360	1
S016359	32mm	14x18mm	360	1
S016360	34mm	14x18mm	360	1
S016361	36mm	14x18mm	360	1
S016362	41mm	14x18mm	360	1
S016363	46mm	14x18mm	360	1
S016388	24mm	24x32mm	1200	1
S016389	27mm	24x32mm	1200	1
S016367	30mm	24x32mm	1200	1
S016368	32mm	24x32mm	1200	1
S016369	34mm	24x32mm	1200	1
S016370	36mm	24x32mm	1200	1
S016390	38mm	24x32mm	1200	1
S016371	41mm	24x32mm	1200	1
S016372	46mm	24x32mm	1200	1
S016373	50mm	24x32mm	1200	1
S016374	55mm	24x32mm	1200	1
S016391	60mm	24x32mm	1200	1
S016392	65mm	24x32mm	1200	1
S016393	70mm	24x32mm	1200	1

组套工具、套筒及驱动配件、旋具套筒、扳手及快扳、敲击扳手、扭力扳手



工具包, 箱, 车 **TOOLS BAG & STORAGE**

工具包套装、工具包、塑料工具箱、铁工具箱、工具车、铝合金工具箱

Tool bag Set, Tool Bag, Tool Box, Tool Trolley, Aluminium Tool Box

8件套基本维修套装
8 Pc Tool Set

- 采用优质铬钒钢
- 表面镀铬, 镜面抛光处理
- Chrome-Vanadium steel
- Chrome plated, mirror polished

Item no.

S022001

- 1件 7" 钢丝钳
- 1件 8" 活动扳手
- 1件 一字螺丝刀 6 x 100mm
- 1件 十字螺丝刀 #2 x 100mm
- 1件 3.5m 橡塑卷尺
- 1件 18mm 美工刀
- 1件 电笔 100-500v
- 1件 8oz 钢管羊角锤

20件套通用工具套装
20 Pc Tool Set

- 采用优质铬钒钢
- 表面镀铬, 镜面抛光处理
- Chrome-Vanadium steel
- Chrome plated, mirror polished

Item no.

S022002

- 1件 3米卷尺
- 6件 6件金属精密钟表螺丝刀
- 1件 8" 钢丝钳
- 1件 18mm 美工刀
- 1件 8" 活动扳手
- 1件 8-3/4" 袖珍钢锯
- 1件 双色柄螺丝刀 #1 x 100mm
- 1件 双色柄螺丝刀 #2 x 150mm
- 1件 双色柄螺丝刀 5 x 100mm
- 1件 双色柄螺丝刀 5 x 150mm
- 1件 双色柄螺丝刀 6 x 150mm
- 1件 双色柄平行一字头螺丝批 5.0 x 100mm
- 1件 8oz 钢管羊角锤
- 1件 数显测电笔
- 1件 迷你手电筒

25件套通用工具套装
25 Pc Tool Set

- 采用优质铬钒钢
- 表面镀铬, 镜面抛光处理
- Chrome-Vanadium steel
- Chrome plated, mirror polished

Item no.

S022003

- 1件 3.5米橡塑卷尺
- 1件 十字双色柄螺丝刀 #1 x 100mm
- 1件 十字双色柄螺丝刀 #2 x 150mm
- 1件 一字双色柄螺丝刀 5 x 150mm
- 1件 一字双色柄螺丝刀 6.0 x 100mm
- 10件 套内六角扳手: 1.5, 2, 2.5, 3, 4, 5, 5.5, 6, 8, 10mm
- 1件 8" 麻柄钢丝钳
- 1件 6" 麻柄尖嘴钳
- 1件 18mm 塑柄金属护套美工刀
- 1件 8" 活动扳手
- 1件 袖珍钢锯
- 1件 电笔 100-500v
- 1件 8oz 钢柄羊角锤
- 1件 迷你手电筒
- 1件 电工绝缘胶带
- 1件 防静电刷子

双肩工具包
Tool Bag

- 采用600D防水涤纶复合材料
- 多口袋设计, 便于存放工具
- 加厚内衬, 增加耐磨度, 经久耐用, 携带方便
- 600D waterproof polyester composite
- More bags for tool place
- Thickened liner, better for wear resistance and convenience

新品

Item no.

S023019

Size

17"

LXWXH

350X190X430mm



1

工具背包
Tool Bag

- 采用1680D防水涤纶复合材料
- 多口袋设计, 便于存放工具
- 加厚内衬, 增加耐磨度, 经久耐用, 携带方便
- 1680D waterproof polyester composite
- more bags for tool place
- thickened liner, better for wear resistance and convenience

Item no.

S023013

Size

18"

LXWXH

350X220X450mm



1

拉杆工具包
Tool bag with trolley

- 采用1680D防水涤纶复合材料, 防水耐磨
- 多口袋设计, 方便存放不同工具
- 可伸缩拉杆设计, 优质脚轮, 便于运输, 携带
- Water resistant 1680d nylon fabric, waterproof polyester
- Multi pouches design, easy to storage tools
- With trolley, better for transportation

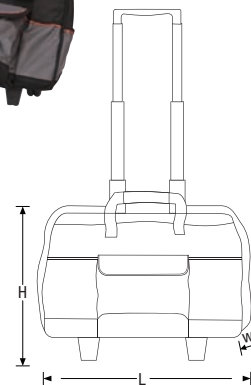
Item no.

S023012

L(mm)

440

H(mm)

340

W(mm)

260



1

工具包

Tool Bag

- 1680D防水涤纶复合面料
- 多口袋设计, 便于存放工具
- 经久耐用, 携带方便
- Material: 1680D waterproof polyester
- Various pockets for tools
- Durable, easy to carry

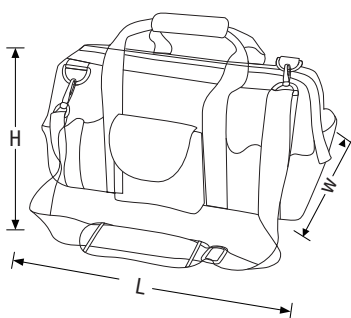

Item no.	Size(mm)	L(mm)	W(mm)	H(mm)	
S023001	13"	315	170	180	1
S023002	17"	415	210	210	1
S023003	19"	490	230	240	1

钢管工具包

Steel Tube Tool Bag

- 1680D防水涤纶复合面料
- 多口袋设计, 便于存放工具
- 拎手牢固, 背带可拆卸
- Material: 1680D polyester, water-resistant
- Multiple pockets for all your items
- Sturdy top handle and detachable shoulder strap



Item no.	Size(mm)	
S023005	500x240x340	1

工具腰包

Waist Tool Bag

- 1680D防水涤纶复合面料
- 多口袋设计, 便于存放工具
- 经久耐用, 携带方便
- Material: 1680D polyester
- Various pockets for tools
- Durable, easy to carry



Item no.	Size(mm)	
S023009	255x270	1

工具包

Tool Bag

- 1680D防水涤纶复合面料
- 多口袋设计, 便于存放工具
- 拎手牢固, 背带可拆卸
- Material: 1680D polyester
- Multiple pockets for all your items
- Sturdy top handle and detachable shoulder strap



Item no.	Size(mm)	
S023006	460x95x275	1

电工工具包

Electrician's Tote

- 1680D防水涤纶复合面料
- 多口袋设计, 便于存放工具
- 经久耐用, 携带方便
- Material: 1680D polyester
- Various pockets for tools
- Durable, easy to carry



Item no.	Size(mm)	
S023010	220x215x390	1

3件套工具挂包

Tool Bag

- 1680D涤纶面料
- 多口袋设计, 便于存放工具
- 经久耐用, 携带方便
- Material: 1680D polyester
- Various pockets for tools
- Durable, easy to carry



Item no.	Size(mm)	
S023004	630x265	1

双层工具包

Dual-layer Tool Bag

- 1680D防水涤纶复合面料
- 多口袋设计, 便于存放工具
- 经久耐用, 携带方便
- Material: 1680D polyester
- Various pockets for tools
- Durable, easy to carry



Item no.	Size(mm)	
S023007	380x150x320	1

工具围裙

Tool Apron

- 1680D防水涤纶复合面料
- 多口袋设计, 便于存放工具
- 经久耐用, 携带方便
- Material: 1680D polyester
- Various pockets for tools
- Durable, easy to carry



Item no.	L(mm)	H(mm)	
S023011	565	500	1

4袋式组合腰包

Tool bag

- 采用900D高级防水涤纶复合材料，结实耐用
- 支撑式口袋，独特剪裁设计，满足各种工具存放携带
- 加厚内衬，增加耐磨度，承重能力更强
- Material: 900D polyester, strong and durable
- Supporting bags and unique tailoring and design for easy storage and carrying of various tools
- Thickened lining, increased wear resistance and higher load carrying capacity

新品



Item no.	L(mm)	H(mm)	
S023015	240	120	1

工具腰带

Tool Belt

- 600D防水尼龙龙材料
- Material: 1680D polyester
- 经久耐用，携带方便
- Durable, easy to carry

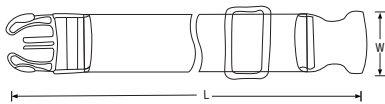

Item no.	L(mm)	w(mm)	
S023014	1220	50	10

强力塑料工具箱

Heavy-duty Plastic Tool Box

- 箱体采用强力PP材料，高强度，耐冲击
- 提手、锁扣采用ABS工程塑料，坚固耐用
- 内含托盘，采用组合式隔断结构，可自由拆卸、分割、组合进行储存
- Body adopts heavy-duty PP material, high strength, impact resistant
- Handle and latch use ABS engineering plastic, strong and durable
- With lift-out tray, removable dividers allow free combination of tools and small parts storage

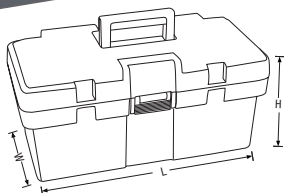

Item no.	Size	L(mm)	W(mm)	H(mm)	
S024004	15"	370	195	185	10

强力塑料工具箱

Heavy-duty Plastic Tool Box

- 箱体采用强力PP材料，高强度，耐冲击
- 提手、锁扣采用ABS工程塑料，坚固耐用
- 内含托盘，采用组合式隔断结构，可自由拆卸、分割、组合进行储存
- Body adopts heavy-duty PP material, high strength, impact resistant
- Handle and latch use ABS engineering plastic, strong and durable
- With lift-out tray, removable dividers allow free combination of tools and small parts storage

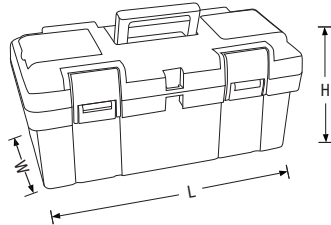

Item no.	Size	L(mm)	W(mm)	H(mm)	
S024005	17"	420	220	195	8
S024006	19"	450	245	210	6

塑料零件盒

Plastic Tool Box

- 采用优质环保材料制作，高透明度
- 内含可快速拆卸层板，方便组合，便于存放各种零件
- 具有防油、耐冲击、抗腐蚀等特点
- Transparent for quick identification of contents
- Built-in removable tray optimizes space
- Special material design, oil, impact-resistant & chemical resistant

产品不包含图片中零件
Accessories in the picture are not included



Item no.	Size(mm)	
S024011	140x75x27	12
S024012	167x126x62	12
S024013	205x140x45	12
S024014	234x168x62	12
S024015	300x200x62	12

手提工具箱

Hand-away Tool Box

- 全金属结构设计，表面砂漆，防锈能力强，抗刮擦，抗溶解
- 金属锁扣，提手牢固耐用
- Sand painting surface, high rust-proof ability, anti-friction, anti-dissolution
- All steel construction

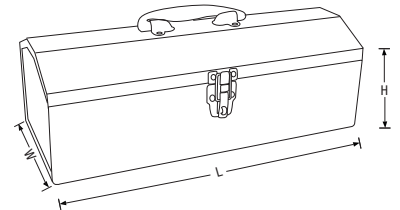

Item no.	Size	L(mm)	W(mm)	H(mm)	
S025001	14"	360	150	115	1

手提工具箱

Hand-away Tool Box

- 全金属结构设计，表面砂漆，防锈能力强，抗刮擦，抗溶解
- 金属锁扣，提手牢固耐用
- Sand painting surface, high rust-proof ability, anti-friction, anti-dissolution
- All steel construction

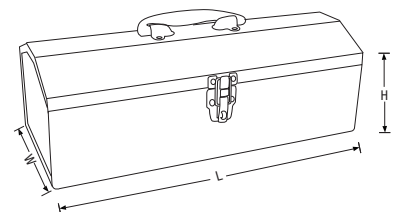

Item no.	Size	L(mm)	W(mm)	H(mm)	
S025002	17"	420	175	140	1

手提工具箱

Hand-away Tool Box

- 全金属结构设计，表面砂漆，防锈能力强，抗刮擦，抗溶解
- 内含层板，利于有序存放物品
- 金属锁扣，提手牢固耐用
- Sand painting surface, high rust-proof ability, anti-friction, anti-dissolution
- Partitioned tool tray
- All steel construction, heavy plated latches and durable plastic top handle



Item no.	Size	
S025003	20" (505x220x245mm)	1

3翻斗工具箱

3 Compartment Cantilever Tool Box

- 3翻斗隔板设计，利于有序存放工具
- 牢固耐用，使用便捷
- 表面烤漆，防锈能力强，抗刮擦，抗溶解
- 3 Storage Trays
- Durable & portable, easy to carry
- Powder coat paint for scratch and chemical resistance



Item no.	Size(mm)	
S025004	410x200x240	1

铝合金工具箱

Aluminium Tool Box

- 铝合金箱体，牢固耐用
- 内置隔板可调整储藏空间
- 抗电击
- Tough aluminum case
- Adjustable dividers
- Shock-resistant

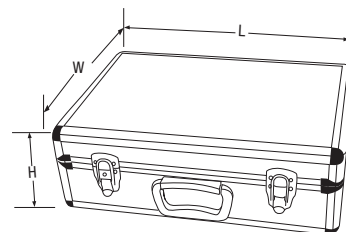

Item no.	L(mm)	W(mm)	H(mm)	
S026001	455	320	150	1

手提工具箱

Hand-away Tool Box

- 全金属结构设计，表面砂漆，防锈能力强，抗刮擦，抗溶解
- 金属锁扣，提手牢固耐用
- Sand painting surface, high rust-proof ability, anti-friction, anti-dissolution
- All steel construction



Item no.	Size	
S025013	14" (360x156x160mm)	1

5翻斗工具箱

5 Compartment Cantilever Tool Box

- 5翻斗隔板设计，利于有序存放工具
- 牢固耐用，使用便捷
- 表面烤漆，防锈能力强，抗刮擦，抗溶解
- 5 Storage Trays
- Durable & portable, easy to carry
- Powder coat paint for scratch and chemical resistance



Item no.	Size(mm)	
S025005	495x200x290	1

铝合金拉杆箱

Aluminium Toolbx Trolley

- 本色加厚全铝拉丝面板
- 内有两块工具板，可轻松放置工具，安全方便
- 内置伸缩拉杆，伸缩顺畅，坚固耐用
- 加强黑色尼龙脚轮，更长使用寿命
- Natural thick aluminum wire drawing panel, black plastic carrying handle
- There are two tool panels, safe and convenient
- Built-in telescopic rod, smooth and durable
- Heavy duty black nylon castors, longer service life

新品



Item no.	L(mm)	W(mm)	H(mm)	
S026002	470	240	350	1

手提工具箱

Hand-away Tool Box

- 全金属结构设计，表面砂漆，防锈能力强，抗刮擦，抗溶解
- 金属锁扣，提手牢固耐用
- Sand painting surface, high rust-proof ability, anti-friction, anti-dissolution
- All steel construction



Item no.	Size	
S025014	17" (435x156x160mm)	1

2抽屉工具箱

Tool Box

- 全金属结构设计，牢固耐用
- 双插销设计
- 抽屉采用滚珠滑轨
- 顶部可以存放工具
- All steel construction
- Double latch system
- Ball bearing glides on drawers
- Top storage area



Item no.	Size(mm)	
S025010	510x218x250	1

工业级重型工具仓储车 Industrial-grade Heavy Tool Trolley

新品

注：工具仓储车不包含单件工具



工具车顶部增加伸展挂板，可放置工具及文件、图纸，更加贴合实际使用环境需求
Increase extendable hanging plates on top of the trolley for storage of tools, documents and drawings, meet the need of practical use of the environment



工具车采用1.3mm厚冷轧钢板，保证强度，牢固结实
Body made from super-strength cold-rolled plate, ensure the intensity, solid and strong



一键式快速锁紧结构，只需轻按，即可快速锁紧整车抽屉，操作轻松、便捷，有效防止工具车推行过程中的抽屉滑脱现象
One-touch quick lock system, just one tap, you can quickly lock drawers, easy operation and convenient, to effectively prevent them from opening accidentally during trolley movement



工具车四角装配橡胶护角，防撞、耐冲击
Assemble rubber protectors on tool trolley corners, collision and impact resistance



抽屉采用重型专利复合材料导轨，推拉顺畅、自如且无噪音，抽屉可100%拉出，单个抽屉可承重85KG
Heavy duty patented composite drawer rails, sliding smoothly, freely and without noise, drawer can 100% pull out, each drawer features full length pulls and 85kg load bearing capacity



工业级重型结构设计，工具车侧面独有增加边柜储存结构，挂板增加挂孔，可根据各种工具外形自由搭配挂钩，有效利用空间，更好进行规整及管理
Industrial grade heavy duty structural design, unique tool cart side storage structure, hanging plates for increased hanging holes, hooks can be mixed according to various tool shapes, efficient use of space for better organized management



4个工业级重型脚轮，整体可承重600KG，专利结构刹车系统，使用便捷、锁紧牢固
4 industrial grade heavy duty castors with 600kg load bearing, patented brake system, easy to use and solid locking

Item no.	L(mm)	W(mm)	H(mm)	挂板高度	
S025015	1000	600	825	500	1

7抽屉工具车 Tool Trolley

升级

- 易滑、全伸展滚珠滑轨设计，抽屉伸展自如，圆弧形大饰条把手设计及安全护套，使用更舒适放心。
- 安全方便的内锁装置，专利型进口宝塔锁，保证使用者工具安全。
- 小抽屉承重20KG，大抽屉承重25KG。
- 工具车有2个固定脚轮，2个双刹方向轮，经久耐用，可承受500KG,超重型脚轮及加厚箱体保证工具车的牢固，软性TPR材料重型5"X2"脚轮，不仅承重力强，还能有效克服不平路面所带来的震动。
- 每只抽屉中均有保护衬垫，增加抽屛卡条，轻松达到产品分类。抽屛增加侧面自锁装置，防止工具车推行过程中抽屛自行打开，使用更安全。
- 顶部配有10mm护垫，更有效保护工具箱上表面操作台。
- 7 Ball-bearing drawers
- General locking for extra security
- 2 fixed castors & 2 swivel castors with total brake, 500kg load capacity
- Posi-Latch drawer securing system to keep drawers closed during moving
- 10mm cushion on top protect the working platform



专利型进口宝塔锁，锁控强劲，安全耐用。
Patent general locking for extra security



工具车整体钢板厚度增加33%；抽屛钢板厚度增加43%；
易滑、全伸展滚珠滑轨设计，抽屛伸展自如。
工具车颜色由原橘红色改为工业灰，更贴切使用环境。

The whole steel plate thickness increase 33%; drawer steel plate thickness increase 43%. Extra heavy duty ball-bearing slides for smooth operation
The original color orange was redesigned into industrial gray.



抽屛外观升级：抽屛饰条升级为圆弧形大饰条，更加坚固、美观；

Exterior upgrade: Upgrade drawer trim to curved molding, more sturdy and artistic;



导轨和轨道，由原卡点安装升级为铆接安装，抽屛固定更加牢固、顺滑；6、7、8抽工具车，底层的抽屛升级为双导轨，承重能力提升50%以上；

Structure upgrade: Slides and rails were upgraded for rivet installation; drawers are fixed more solid and smooth. For 6-Drawer, 7-Drawer and 8-drawer tool trolleys, bottom drawer was upgraded to dual rail, load-bearing capacity increase more than 50%.



脚轮升级为重型“风火轮”，承重能力提升15%。

Load-bearing upgrade: wheels were upgraded to heavy "hot wheels", load-bearing capacity increase 15%;

5抽屉工具车

Tool Trolley

- 5抽屉设计, 滚珠滑轨结构, 单个抽屉可承重35KG
- 表面烤漆, 防锈能力强, 抗刮擦, 抗溶解
- 5寸重型脚轮, 可承重300KG, 推行时无噪音, 使用寿命长
- 刹车系统安全可靠
- Designed with 5 drawers and ball sliding rail, each drawing max bears 35KG
- Baking finished surface, free from rust, scratch and dissolution
- 5 inch heavy duty caster with load bearing 300kg, no noise and long lifetime
- Safe and reliable braking system

新品

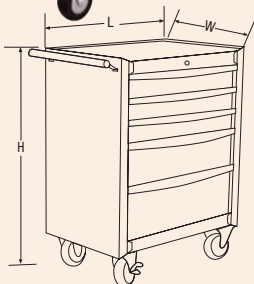

Item no.	L(mm)	W(mm)	H(mm)	
S025011	676	459	702	1

6抽屉工具车

Tool Trolley

- 6抽屉, 滚珠滑轨结构, 带自锁功能
- 表面烤漆, 防锈能力强, 抗刮擦, 抗溶解
- 刹车系统安全可靠
- 脚轮机动, 灵便, 耐用
- 6 Ball-bearing drawers
- Powder coat paint for superior scratch and chemical resistance
- Internal locking system for extra security
- Wheels for mobility, convenience & durable

升级



Item no.	L(mm)	W(mm)	H(mm)	
S025006	688	458	885	1

7抽屉工具车

Tool Trolley

- 7抽屉, 滚珠滑轨结构, 带自锁功能
- 表面烤漆, 防锈能力强, 抗刮擦, 抗溶解
- 刹车系统安全可靠
- 脚轮机动, 灵便, 耐用
- 7 Ball-bearing drawers
- Powder coat paint for superior scratch and chemical resistance
- Internal locking system for extra security
- Wheels for mobility, convenience & durable

升级

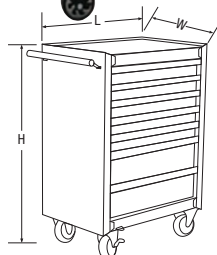

Item no.	L(mm)	W(mm)	H(mm)	
S025007	680	458	995	1

8抽屉工具车

Tool Trolley

- 顶部木质工作台面, 方便耐用
- 8抽屉, 滚珠滑轨设计, 带自锁功能
- 表面烤漆, 防锈能力强, 抗刮擦, 抗溶解
- 刹车系统安全可靠
- 脚轮机动, 灵便, 耐用
- Wood worktop
- 8 Ball-bearing drawers
- Powder coat paint for superior scratch and chemical resistance
- Internal locking system for extra security
- Wheels for mobility, convenience & durable

升级

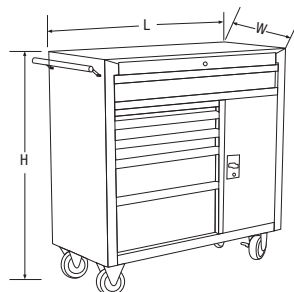

Item no.	L(mm)	W(mm)	H(mm)	
S025008	1035	458	1052	1

网格工具车

Plastic Tool Box

- 车身采用优质冷轧钢板, 内部采用钢丝网, 方便工具管理
- 顶部增加塑料托盘, 更加方便归整工具
- 卷帘门设计, 轻松方便
- 4个3寸橡胶承重脚轮, 便于推行
- 整体承重110KG
- Body made from super-strength cold-rolled steel tubes, use steel wire mesh to arrange tools easily
- external plastic plate designed for storing tools
- Crimp door designing, extending service life
- 3" 4 rubber wheel
- Capacity: 110KG

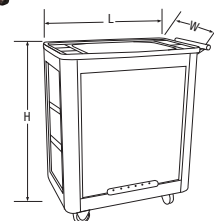

Item no.	L(mm)	W(mm)	H(mm)	
S025012	635	390	900	1

3层多用途工具推车

Tool Trolley

- 表面烤漆, 防锈能力强, 抗刮擦, 抗溶解
- 刹车系统安全可靠
- 脚轮机动, 灵便, 耐用
- Powder coat paint for superior scratch and chemical resistance
- Professional quality design is perfect for any garage or workplace
- Internal locking system for extra security
- Wheels for mobility, convenience & durable

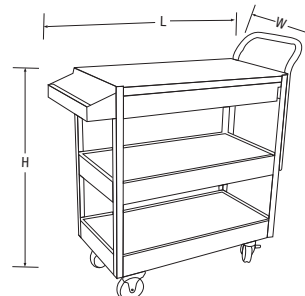

Item no.	L(mm)	W(mm)	H(mm)	
S025009	737	383	850	1

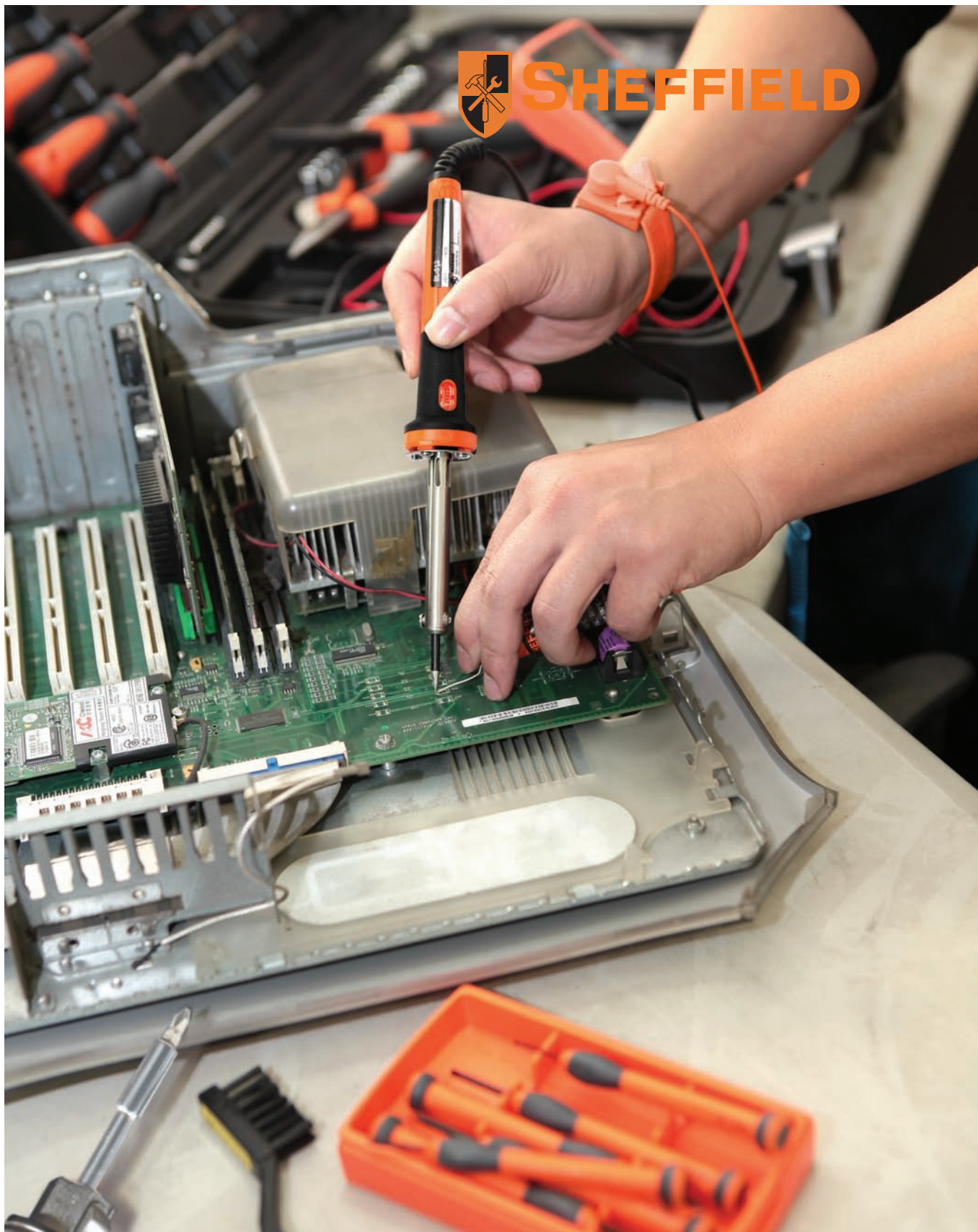

电子电工类工具 **ELECTRICAL TOOLS**

套装类、手电筒、万用表、测电类、镊子、电工电子钳、电缆剪、电工剪刀、精密螺丝批、电烙铁及附件
Tool Set, Flashlight, Tweezer, Voltage Tester, Pliers, Crimping Tool, Screwdriver, Electric Iron

57件套电讯维修组套

57 Pc Tool Set

- 采用优质铬钒钢 • Chrome-Vanadium steel
- 表面镀铬, 镜面抛光处理 • Chrome plated, mirror polished

CR-V

Item no.

S010057



1

- 13件 6.3mm系列公制六角标准套筒: 4, 4.5, 5, 5.5, 6, 7, 8, 9, 10, 11, 12, 13, 14mm
- 2件 6.3mm系列旋柄, 6.3mm系列旋具接头
- 1件 6"活扳手
- 3件 双色柄一字螺丝刀 3 x 75, 5 x 100, 6 x 100mm
- 3件 双色柄十字螺丝刀十字: PH0 x 75, PH1 x 100, PH2 x 150mm
- 1件 塑料零件盒 140x75x27MM
- 4件 迷你手电筒, 尖头镊子, 数显测电笔, 自动剥线钳
- 1件 8合1 铝合金手柄钟表螺丝批
- 2件 直刃电刀, 电工剪
- 3件 8"双色柄斜嘴钳, 6"双色柄尖嘴钳, 6"双色柄斜嘴钳
- 5件 电烙铁 30W/220V, 筒装焊锡丝, 全铝吸锡器, 电工绝缘胶带, 防静电刷子
- 8件 8件套折叠式公制内六角扳手 1.5, 2, 2.5, 3, 4, 5, 5.5, 6mm
- 3件 6.3mm系列25mm长十字旋具头: PH1, PH2, PH3
- 3件 6.3mm系列25mm长一字旋具头: 4, 5.5, 6.5mm
- 3件 6.3mm系列25mm长花型旋具头: T10, T15, T20
- 1件 18mm塑柄金属护套美工刀
- 1件 卷尺 3m

55件套电讯工具套装

55 Pc Tool Set

Item no.

S033001



1

- 1件 数显万用表
- 4件 双色柄十字螺丝刀: #1 x 75, #1 x 150, #2 x 45, #2 x 100mm
- 4件 双色柄一字螺丝刀: 3 x 75, 3 x 150, 6 x 40, 6 x 100mm
- 3件 橡塑卷尺 3.5m; 8"直刃电刀; 6"双色柄尖嘴钳
- 4件 6"双色柄斜嘴钳; 8"双色柄钢丝钳; 袖珍钢锯; 10"活扳手
- 3件 7"鹰嘴剥线钳; 迷你手电筒; 电工绝缘胶带
- 10件 链式内六角扳手: 1.5, 2, 2.5, 3, 4, 5, 5.5, 6, 8, 10mm
- 2件 6.3mm系列旋柄; 6.3mm系列起子变换头
- 13件 6.3mm系列公制六角标准套筒: 4, 4.5, 5, 5.5, 6, 7, 8, 9, 10, 11, 12, 13, 14mm
- 6件 精密钟表螺丝刀: #0, #1, 1.4mm, 1.8mm, 2.4mm, 3.0mm
- 5件 电烙铁 30W/220V; 焊锡丝; 吸锡器; 数显测电笔; 镊子

变形金刚超亮LED手电筒 LED Flashlight

- 外壳采用铝合金包塑特别设计, 结实耐用。
- 进口超亮CREE LED灯珠, 使用寿命100000小时以上。
- 特有防雨淋防震设计。



特殊橡塑材料, 设计, 抗压防震。
Rubberized aluminum case



专利开关设计, 舒适耐用。
Durable switch on/off button

Item no.	Power	LM	Battery	
S030006	1W	40	3节7#电池	6
S030007	1W	40	2节5#电池	6
S030008	3W	70	2节1#电池	6

21件套高级通用工具包

21 Pc Tool Set

Item no.

S033002



1

- 1件 6件套精密钟表螺丝刀
- 4件 8"钢丝钳; 6"尖嘴钳; 8"活动扳手; 割刀9mm
- 1件 测电螺丝刀(电笔) 100-500VAC, 150mm
- 1件 双色手柄一字头螺丝刀 3 x 100mm
- 1件 双色手柄十字头螺丝刀 #0 x 100mm
- 1件 双色手柄一字头螺丝刀 6.0 x 150mm
- 1件 双色手柄十字头螺丝刀 #2 x 150mm
- 2件 电烙铁 30W/220V; 强力型 3.5m 卷尺
- 1件 10件套链式内六角扳手: 1.5, 2, 2.5, 3, 4, 5, 5.5, 6, 8, 10mm
- 5件 木柄羊角锤 12oz; 袖珍钢锯; 迷你手电筒; 尖头镊子; 不锈钢剪刀
- 3件 电工绝缘胶带; 6"带刃口剥线钳; 筒装焊锡丝

23件电讯套装

23 Pc Tool Set

Item no.

S033003



1

- 5件 3米卷尺; 迷你数字万用表; 8"鲤鱼钳; 6"尖嘴钳; 8"活动扳手
- 10件 10件套内六角扳手: 1.5, 2, 2.5, 3, 4, 5, 5.5, 6, 8, 10mm
- 1件 十字双色柄螺丝刀: #1 x 100mm
- 1件 一字双色柄螺丝刀: 5 x 100mm
- 3件 数显测电笔; 迷你手电筒; 电工绝缘胶带
- 2件 弯刃电刀; 6"带刃口剥线钳
- 1件 尖头镊子

15件套电脑维修包

15 Pc Tool Set



Item no.

S033004

1

- 2件 4-1/2"迷你斜嘴钳; 4-1/2"迷你尖嘴钳
- 1件 十字双色柄螺丝刀: #0 x 75
- 1件 十字双色柄螺丝刀: #1 x 200
- 1件 一字双色柄螺丝刀: 3 x 75MM
- 1件 一字双色柄螺丝刀: 5 x 75MM
- 1件 双色柄花型螺丝刀T10 x 100MM
- 1件 双色柄花型螺丝刀T15 x 100MM
- 4件 6"带刃口剥线钳; 特尖头镊子; 防静电刷子; 筒装焊锡丝
- 3件 全铝吸锡器; 电烙铁 30W/220V; 可调试防静电手带

铝合金软管电筒

Aluminum Alloy Hose Flashlight

- 铝合金外壳, 氧化处理, 美观耐用
- 金属照明软管, 可任意弯曲, 适应各种狭小空隙照明
- Aluminum alloy shell, durable performance
- Metal lighting hose, adapt to a variety of small space
- Uses 2pcs AA batteries, white LED lumens than 6LM
- Belt buckle design, easy to carry



Item no.

S030016

Hose (L)

Handle(L)

10

高强度铝合金手电筒

Heavy Duty Flashlight

- 重型铝合金外壳, 结实牢固
- 采用优质LED灯珠
- 采用防雨淋防震设计
- Heavy duty aluminum body
- Super LED for extra brightness
- Water & shock resistant



Item no.

S030001

Bulb

LM

Battery

12

高强度铝合金手电筒

Heavy Duty Flashlight

- 重型铝合金外壳, 结实牢固
- 采用优质LED灯珠
- 采用防雨淋防震设计
- Heavy duty aluminum body
- Super LEDs for extra brightness
- Water & shock resistant



Item no.

S030003

Bulb

LM

Battery

6

S030004

20 LED

60

2D (2节1#电池)

6

S030005

20 LED

60

3D (3节1#电池)

6

3W超亮LED头灯

3W LED Headlamp

- 采用优质ABS工程塑料材质外壳, 坚固耐用
- 内含3W进口超亮CREE LED, 高亮度, 节能
- 灯头带可调棘轮装置, 镜头特有铝合金可伸缩调焦装置, 方便多角度, 多环境使用照明
- 使用3节AAA电池, 3档控制开关
- High impact-resistant ABS case
- Hi-intensity CREE LED bulb
- Pivoting aluminum head
- Zoom in/out to adjust focus-on
- Uses 3pcs AAA batteries, 3-position switch



Item no.

S030012

Power

LM

Battery

6

3W

70

3AAA (3节7#电池)

8LED头灯

LED Headlamp

- 采用ABS工程塑料材质外壳, 坚固耐用
- 内含8颗LED, 使用寿命长, 节能
- 使用3节AAA电池, 3档控制开关
- Durable high impact-resistant ABS case
- Super bright 8 LED bulbs for longer life, never need replacing
- Uses 3pcs AAA batteries, 3-position switch



Item no.

S030011

Bulb

Battery

6

8LED

3AAA(3节7#电池)

42LED充电式工作灯

Rechargeable 42LED Flashlight

- 产品采用ABS材质, 抗压耐摔
- 42LED灯珠, 高亮度, 节能
- 充电完成后, 可连续使用5个小时
- 照射范围: 5m范围以内
- ABS material, good for high drop number
- With 42 LED, high luminance & energy saving
- After charging is completed, can be used continuously for 5 hours
- Irradiation range: within the range of 5m

新品



Item no.

S030023

Power

IP(防水)

LM

10

42

65

150

充电式LED手电筒

Rechargeable LED Flashlight

- 采用优质航空铝合金材料, 表面氧化处理, 美观、防雨淋、耐用
- 进口超亮CREE LED灯珠, 使用寿命达100000小时, 照射距离可达100米
- 采用优质环保PC材质镜片, 高透明度, 耐压, 耐热
- 特殊设计开关, 舒适耐用
- 可车载及220V充电, 可连续使用3小时以上
- Aluminium alloy body, rust & water resistant
- 3 Watt CREE LED(USA) lifetime lasts up to 100,000 hours, effective illuminated distance: 100m
- PC environmental protection glass, high transparency, shock resistant
- Durable switch on/off button
- Battery run time: 3 hours (8 hours charge time)

升级



Item no.

S030010

Power

LM

6

3W

300

超亮充电式LED手电筒

Rechargeable LED Flashlight

- 采用优质航空铝合金材料, 表面氧化处理, 美观、防雨淋、耐用
- 进口超亮CREE LED灯珠, 使用寿命达100000小时, 照射距离可达100米
- 采用优质环保PC材质镜片, 高透明度, 耐压, 耐热
- 特殊设计开关, 舒适耐用
- 可车载及220V充电, 可连续使用3小时以上
- Aluminium alloy body, rust & water resistant
- 3 Watt CREE LED(USA) lifetime lasts up to 100,000 hours, effective illuminated distance: 100m
- PC environmental protection glass, high transparency, shock resistant
- Durable switch on/off button
- Battery run time: 3 hours (8 hours charge time)

新品



Item no.

S030017

Power

IP(防水)

LM

6

3W

65

300

多功能充电手电筒

Multifunctional Rechargeable Flashlight

- 重型铝合金外壳，结实耐用
- 内含进口超亮CREE LED，高亮度，节能
- 采用优质3.6V可充电锂电池，可连续使用9小时
- 三挡控制开关，强光，弱光，爆闪3种照明模式
- Heavy Aluminum alloy shell, durable performance
- Imported CREE LED, higher luminance with longer battery life
- High quality of 3.6V lithium battery, continuous usage to 9 hours
- Three modes of switch for strong light, weak light and flashing light

升级



Item no.	Power	LM	Battery	
S030014	1W	80	18650	6

磁性万向LED工作灯

Rotating Magnetic LED Work Light

- 采用优质铝合金材质外壳，表面阳极氧化处理，耐磨美观
- 内含超亮24颗LED，高亮度，节能
- 专利设计超强磁力万向底座，可轻松吸附金属表面使用
- Anodized aluminum case
- 24 super bright LED bulbs for longer life
- Patented strong magnetic base can attach any ferrous surface
- Aluminum lighted head rotates to adjust beam to needed angle.



Item no.	Bulb	Battery	
S030013	24LED	3AAA (3节7#电池)	6

多功能充电工作灯

Multi-function chargeable work light

- 主灯采用1.5W大功率LED灯珠，亮度高，节能灯罩采用3mm厚度透明钢化玻璃，高透明度，耐油，抗压
- 高性能3.7V可充锂电池，容量1500mAh，充电后，可连续使用3小时
- 防尘防雨淋设计，有效照射距离超过600M以上
- 三挡控制开关，强光，弱光，闪光
- 1.5W LED lamp, super brightness with less energy
- Lampshade is made of transparent roughened glass, resist oil and stress
- High-performance 3.7V rechargeable Lithium battery with 1500mAh capacity
- Can be continuously used for 3 hours
- Dustproof a waterproof, lighting distance can exceed 600M
- 3 position for switch :strong light, light and glitter



Item no.	Power	LM	
S030021	1W	65	6

外星人工作灯 Alien Work Light

- 360度可弯曲旋转支架
- 超强磁力支架底座，方便任意工作环境使用
- 弹性活动关节，可快捷任意转动或造型
- 4档开关控制，3种照明模式，操作方便
- 独特专利外观设计，美观新颖
- 超亮进口LED灯珠，节能耐用
- 360° degree Swivel joint tripod design, easy to stand with any angle or hold with pole
- Magnetic base, available with any metal surface
- 4 stage switch: 9LED light ON / 19 LED light ON / Emergency light ON / OFF
- 3 lighting models simplified operation
- Patented design
- Intensity LED light

**SHEFFIELD
专利产品**



Item no.	Bulb	Battery	
S030009	19 LED	3AAA (3节7#电池)	6

工业级360度全影像内窥镜 Industrial Endoscope

- 进口1m高清便携式双向旋转内窥镜，可向左/向右转弯，幅度达330度
- 45万像素，影像超清晰
- 软管可旋转360度
- 超高亮度LED灯，亮度可调整，黑暗角落也可清楚呈现
- IP67防水设计
- 内窥镜搭配1M长度软管
- 产品应用范围：汽车，发动机，机械维修检测管道，建筑结构查视，科学实验，户外探测，生命探测与救助
- 家庭辅助查视难以看到和接触到的位置
- 1m imported HD portable with two-way rotating mirror, can turn left / right, the magnitude of 330 degrees
- 450,000 pixels camera provides ultraclear view
- 360 degrees rotatable soft tube
- Ultra - bright LED lights with adjustable luminance to view even dark corners clearly
- Waterproof level: IP67
- Endoscopies go with 1 meter soft tube
- Application Automobile, engine, mechanical maintenance and inspection
- Pipeline, building structure inspection
- Scientific experiment
- Outdoor detection, life detection and rescue
- Assist to inspect domestic place that is difficult to see and access

此产品为非常规库存产品，需要一定的交货期

新品



功能特点参数：

图像传感器：	1/12"VGA 彩色感应器
像素：	720X525(N) / 720X625(P)
显示屏：	3.5"TFT LCD彩显屏
镜头和插入管尺寸：	Ø5.5mm x 1000mm
视场角：	67°
清晰视距：	1.5 - 10cm
光源：	4颗LED白光灯提供照明
储存介质：	2GB SD卡
视频输出 AV OUT：	有
防水/防油等级：	IP67
电池：	可充电锂电3.7V
电源：	100 - 240VAC输入
	5.5V VDC输出
工作保存温度：	-20 - -60 °C
充电温度：	0 - 40 °C
配件：	充电器，说明书，工具箱

Item no.	
S034005	1



套装类、手电筒、万用表、测电类、镊子、电工电子钳、电缆剪、电工剪刀、精密螺丝批、电烙铁及附件

数字万用表

Digital Multimeter

- 具备测量直流电压，交流电压，直流电流，交流电流，电阻，电容，频率，频响，占空比等功能。
- 同时还具备二极管，EF测试，三极管，通断蜂鸣。
- 全符号显示，低电压提示，数据保持，自动关机，夜视背光功能。
- 超大屏幕，大数字显示，高解析度模拟指针同步显示功能。
- 全量程过载保护设计，保证使用安全。
- 机身采用双色橡塑材料，美观，绝缘，抗压。
- This meter features an extra large display making it very easy to read. It has a multitude of useful features including transistor tester, capacitor, frequency and temperature ranges.
- When a range is selected the correct test lead connections are indicated on the display.
- The auto power off feature switches the unit off after 15 minutes of inaction, saving battery power.
- Bi-color rubber holster for impact-resistance



多功能测试设置，使用范围广。

超大LCD显示屏，大数字显示，读数方便。

Multiple test functions including voltage, current, resistance, capacitance, and frequency etc.

64×43mm LCD, 41-segment analogy bar graph



机身双色橡塑材料，美观，绝缘，抗压。
Rubber holster for impact-resistance

可调节支脚
Adjusting tilt stand

数字万用表

Digital Multimeter



基本功能	量程	基本精度
直流电压	40mV	
	400mV	±(0.8%+3)
	4V/40V/400V	±(0.5%+1)
	1000V	±(1.0%+3)
交流电压	40mV	
	400mV	±(1.2%+5)
	4V/40V/400V	±(1.0%+3)
	750V	±(1.2%+5)
直流电流	400uA/4000uA	±(1.0%+2)
	40mA/400mA	±(1.2%+3)
	4A/10A	±(1.5%+3)
		±(1.5%+3)
交流电流	400uA/4000uA	±(1.2%+5)
	40mA/400mA	±(1.5%+3)
	4A/10A	±(2.0%+5)
		±(2.0%+5)
电阻	400	±(1.2%+2)
	4K /40K /400K	±(1.0%+2)
	4M	±(1.2%+2)
	40M	±(1.5%+2)
电容	40nF	±(3.0%+5)
	400nF/4uF/40uF	±(3.0%+5)
	400uF	±(4.0%+5)
	4000uF	±(4.0%+5)
频率	10Hz - 10MHz	±(0.1%+4)
频响		45 ~ 400Hz
占空比	0.1% - 99.9%	

特殊功能

自动/手动量程	
二极管	
EF探测	
三极管	
通断蜂鸣	
数据保持	
最大值/最小值	
背景光	
相对测量	
自动关机	约15分钟
模拟条	41段
输入保护	
输入阻抗	10M
低电量显示	7.5V
最大显示	4000

一般特征

电源	9V电池 (6F22)
LCD尺寸	65 × 43mm
机身颜色	橙色 + 灰色
机身重量	370g
机身尺寸	180 × 87 × 47mm
标准配件	电池、表笔、转换插头、说明书、保修卡

货号
S034001

6

自动量程数字万用表

Digital Multimeter

本数字万用表是功能齐全，性能稳定，精度高，功耗低，结构新颖，安全可靠的小型手持式自动量程数字万用表，是广大用户的理想测量仪表。可用于家庭、学校、冶炼、通讯、制造、石油、国防、电力、化工等行业，是电路/电力设备检测、维护和维修的理想工具。

Measures AC/DC voltage and current

Also features resistance, audible continuity, capacitance, frequency
Bright backlit display for working in low lighting conditions



基本功能	量程	基本精度
直流电压	400mV/4V/40V/400V/500V	±(0.8%+1)
交流电压	400mV/4V/40V/400V/500V	±(1.2%+3)
直流电流	400uA/4mA/40mA/400mA/4A/10A	±(1.0%+2)
交流电流	400uA/4mA/40mA/400mA/4A/10A	±(1.2%+5)
电阻	400 /4K /40K /400K /4M /40M	±(1.0%+2)
电容	4nF/40nF/400nF/4uF/40uF/100uF	±(4.0%+3)
频率	10Hz - 10MHz	±(0.5%+3)
占空比	0.1% ~ 99.9%	

特殊功能

二极管测试	
通断蜂鸣	
自动关机	
低压显示	
“电压测量输入阻抗”	10M
数据保持	
最大显示	3999

一般特征

电源	9V电池 (6F22)
LCD尺寸	49 × 18mm
机身颜色	橙色 + 灰色
机身重量	200g
机身尺寸	72 × 137 × 35mm
标准配件	电池、表笔、说明书、保修卡

货号
S034002

6

迷你数字万用表

Mini Digital Multimeter

本产品是一款可随身携带的笔记本式3-3/4位自动量程数字万用表。它功能齐全，性能稳定，精度高，功耗低，结构新颖，安全可靠，是广大用户的理想测量仪表。

可用于家庭、学校、冶炼、通讯、制造、石油、国防、电力、化工等领域，是电路/电力设备维护和维修的理想工具。

Measures AC/DC voltage

Also features resistance, audible continuity, capacitance, frequency.

Bright backlit display for working in low lighting conditions



基本功能	量程	基本精度
直流电压	400mV/4V/40V/300V	±(0.8%+1)
交流电压	4V/40V/300V	±(1.2%+3)
电阻	400 /4K /40K /400K / 4M /40M	±(1.0%+2)
电容	4nF/40nF/400nF/4uF/40uF/ 200uF	±(4.0%+3)
频率	10Hz - 100KHz	±(0.5%+3)
占空比	0.1% - 99.9%	

特殊功能

自动量程
二极管测试
通断蜂鸣
相对值测量
数据保持
全符号显示
自动关机
低压显示
电压测量输入阻抗
最大显示

一般特征

电源 3V纽扣式电池 (CR2032)
LCD尺寸 43 × 22mm
机身颜色 橙色 + 灰色
机身重量 62g
机身尺寸 58 × 108 × 12mm
标准配件 皮套、电池、说明书、保修卡

货号

S034003



6

数字钳式万用表

Digital Multimeter

本产品是一款性能稳定、安全，可靠的3-1/2位数字钳式表。全量程过载保护和独特的外观设计，使之成为性能更为卓越的新一代实用电工测量仪表。

可用于冶炼、制造、石油、电力、化工等行业维护和维修的理想工具。

Measures AC/DC voltage and AC current

Also features resistance, audible continuity

Bright backlit display for working in low lighting conditions



技术指标

基本功能	量程	基本精度
直流电压	200mV/2V/20V/200V/600V	±(0.8%+1)
交流电压	2V/20V/200V/600V	±(1.2%+5)
交流电流	2A/20A/200A/400A	±(1.5%+5)
电阻	200 /2K /20K / 200K /2M /20M	±(1.0%+2)

特殊功能

自动量程
二极管测试
通断蜂鸣
最大值保持
数据保持
全符号显示
自动关机
低电量显示
电压测量输入阻抗
最大显示
钳头开口尺寸
被测导线尺寸

一般特征

电源 1.5V电池 (7#) × 2
LCD尺寸 35.6 × 18mm
机身颜色 橙色 + 灰色
机身重量 220g
机身尺寸 210 × 75.6 × 30mm
标准配件 表笔、电池、布包、说明书、保修卡

货号

S034004



6

测电螺丝刀

Voltage Tester

- 刀杆全硬热处理，经久耐用
- 测量范围：<500VAC
- 产品达到CE测试标准，安全可靠
- Heat treated for longer durability
- Capacity: <500VAC
- CE approved



Item no.	Size(mm)	Test	
S034010	150	100V-500V	20
S034011	180	100V-500V	20

数显测电笔

Digital Voltage Tester

- 测量范围：<220VAC
- 快速感应测试，安全方便
- LED显示屏电压显示
- 产品达到CE测试标准
- Capacity: <220VAC
- Non-contact AC voltage and current detection
- No battery needed, always ready to use
- LED screen display
- CE approved



Item no.	Size(mm)	Test	
S034012	150	12V-220V	12

高档数显测电笔

Digital Voltage Tester

- 测量范围：12 - 250V
- 快速感应测试，安全方便
- LED显示屏电压显示
- 产品达到CE测试标准
- Capacity: 12-250V
- Non-contact AC voltage and current detection
- No battery needed, always ready to use
- LED screen display
- CE approved



Item no.	Size(mm)	Test	
S034013	150	12V-250V	12

端子台工具

Punchdown Tool With 110 Blade

- 钳头采用独特刺刀头锁定结构
- 压力力度可以按需调整
- 精确压线同时切断多余的线头
- 刀头采用弹簧装载机构，
适合在110面板上快速精确操作
- Bayonet-style blade locking mechanism
- Adjustable impact pressure control
- Precisely inserts the wire for a corrosion resistant termination and trims off excess wire
- Spring-loaded blade for fast, accurate seating on standard 110 IDC connectors



Item no.	L(mm)	
S035039	150	10



套装类、手电筒、万用表、测电类、镊子、电工电子钳、电缆剪、电工剪刀、精密螺丝批、电烙铁及附件

尖头镊子

Tweezer

- 不锈钢制造
- 防磁
- Stainless steel
- Anti-magnetic



Item no.	Size(mm)	
S031001	125	12

钢丝钳

4-1/2" Linesman Pliers

- 钳体经锻造热处理, 坚固耐用
- 刃口经特殊处理, 剪切能力强
- 双沾塑手柄, 握持舒适
- 符合美国ANSI标准
- Drop forged steel for longer life and durability
- Heat treated
- Double dipped grip handle
- Meets ANSI standard in USA



Item no.	Size	Capacity(mm)	L(mm)	
S035001	4.5"	钢丝 1.0	116	6

塑料水口钳

Diagonal Pliers

- 钳体经锻造热处理, 坚固耐用
- 刃口经特殊处理, 剪切能力强
- 双沾塑手柄, 握持舒适
- 符合美国ANSI标准
- 适用于剪切塑料制品的浇口、毛边或软性的电线, 不适用于剪切钢丝
- Heat treated
- Double dipped grip handle
- Meets or exceeds ANSI standard
- Drop forged steel for longer life and durability
- Suitable for plastic and soft cable wire but not for steel wire



Item no.	Size	L(mm)	
S035005	5"	127	6
S035006	6"	152	6

特尖头长镊子

Tweezer

- 不锈钢制造
- 防磁
- Stainless steel
- Anti-magnetic



Item no.	Size(mm)	
S031002	135	12

尖嘴钳

4-1/2" Long Nose Pliers

- 钳体经锻造热处理, 坚固耐用
- 刃口经特殊处理, 剪切能力强
- 双沾塑手柄, 握持舒适
- 符合美国ANSI标准
- Drop forged steel for longer life and durability
- Double dipped grip handle
- Meets or exceeds ANSI standard in USA
- Heat treated



Item no.	Size	Capacity(mm)	L(mm)	
S035002	4.5"	钢丝 1.0	131	6

电子水口钳

Electronic Diagonal Pliers

- 采用优质60CR-V材质锻造, 剪切锋利、耐用
- 日式平刃款式, 带弹簧
- 刃口特殊高频淬火处理
- Drop forged with fine 60CR-V steel, sharp and durable
- Japanese flat cutting edge style with return spring
- High-frequency induction hardening to cutting edge



Item no.	Size	Capacity(mm)	
S035051	5"	塑料 3.0mm	12
S035052	6"	塑料 5.0mm	12

宽头镊子

Tweezer

- 不锈钢制造
- 防磁
- Stainless steel
- Anti-magnetic



Item no.	Size(mm)	
S031003	120	12

斜嘴钳

4-1/2" Diagonal Pliers

- 钳体经锻造热处理, 坚固耐用
- 刃口经特殊处理, 剪切能力强
- 双沾塑手柄, 握持舒适
- 符合美国ANSI标准
- Drop forged steel for longer life and durability
- Double dipped grip handle
- Meets or exceeds ANSI standard
- Heat treated



Item no.	Size	Capacity(mm)	L(mm)	
S035003	4.5"	钢丝 1.0	100	6

电子剪切钳

Electronic Cutting Pliers

- 采用优质60CR-V材质锻造, 剪切锋利、耐用
- 日式弯刃款式, 带弹簧
- 刃口特殊高频淬火处理
- Drop forged with fine 60CR-V steel, sharp and durable
- Japanese bent cutting edge style with return spring
- High-frequency induction hardening to cutting edge



Item no.	Size	Capacity(mm)	
S035053	4"	铜丝 1.8, 铁丝 1.0mm	12
S035054	5"	铜丝 2.0, 铁丝 1.2mm	12

弯头镊子

Tweezer

- 不锈钢制造
- 防磁
- Stainless steel
- Anti-magnetic



Item no.	Size(mm)	
S031004	118	12

扁嘴钳

4-1/2" Flat Nose Pliers

- 钳体经锻造热处理, 坚固耐用
- 刃口经特殊处理, 剪切能力强
- 双沾塑手柄, 握持舒适
- 符合美国ANSI标准
- Drop forged steel for longer life and durability
- Double dipped grip handle
- Meets or exceeds ANSI standard
- Heat treated



Item no.	Size	L(mm)	
S035004	4.5"	125	6

电子长嘴钳
Electronic Long Nose Pliers

- 采用优质60CR-V材质锻造, 剪切锋利、耐用
- 日式弯刃款式, 带弹簧
- 刃口特殊高频淬火处理
- Drop forged with fine 60CR-V steel, sharp and durable
- Japanese flat cutting edge style with spring loaded
- High-frequency induction hardening to cutting edge



Item no.	Size	Capacity(mm)	
S035055	5"	铜丝 2.6, 铁丝 1.5mm	12
S035056	6"	铜丝 2.6, 铁丝 1.5mm	12

省力型迷你钢丝钳5"
Mini Linesman's Pliers

- 采用优质55CR-Ni材质锻造, 剪切锋利, 耐用
- 手柄采用双色PP+TPR材质, 握感舒适
- 钳体采用内置弹簧结构, 使用便捷, 可用于高强度流水线作业
- 省力偏心结构, 较普通迷你钳明显省力
- Drop Forged with high quality Cr-Ni, durable and longer using life
- Double color with PP+TPR handle, comfortable foe holding
- Labour-saving spring structure can be used for high strength assembly line operations
- Eccentric shaft design, saving effort than ordinary mini pliers

升级

Item no.	Size	Capacity(mm)	刃口硬度	
S035043	5"	铜丝 \leq 1.5, 铁丝 \leq 1.5	HRC56~62	6
		硬钢丝 \leq 1.2		

省力型迷你顶切钳4.5"
Mini End Cutter Pliers

- 采用优质55CR-Ni材质锻造, 剪切锋利, 耐用
- 手柄采用双色PP+TPR材质, 握感舒适
- 钳体采用内置弹簧结构, 使用便捷, 可用于高强度流水线作业
- 省力偏心结构, 较普通迷你钳明显省力
- Drop Forged with high quality Cr-Ni, durable and longer using life
- Double color with PP+TPR handle, comfortable foe holding
- Labour-saving spring structure can be used for high strength assembly line operations
- Eccentric shaft design, saving effort than ordinary mini pliers

升级

Item no.	Size	Capacity(mm)	刃口硬度	
S035046	4.5"	铜丝 \leq 1.5	HRC56~62	6
		铁丝 \leq 1.5		
		硬钢丝 \leq 1.2		

省力型迷你尖嘴钳5.5"
Mini Long Nose Pliers

- 采用优质55CR-Ni材质锻造, 剪切锋利, 耐用
- 手柄采用双色PP+TPR材质, 握感舒适
- 钳体采用内置弹簧结构, 使用便捷, 可用于高强度流水线作业
- 省力偏心结构, 较普通迷你钳明显省力
- Drop Forged with high quality Cr-Ni, durable and longer using life
- Double color with PP+TPR handle, comfortable foe holding
- Labour-saving spring structure can be used for high strength assembly line operations
- Eccentric shaft design, saving effort than ordinary mini pliers

升级

Item no.	Size	Capacity(mm)	刃口硬度	
S035041	5.5"	铜丝 \leq 1.5	HRC56~62	6
		铁丝 \leq 1.5		
		硬钢丝 \leq 1.2		

省力型迷你弯嘴钳5.5"
Mini Bent Nose Pliers

- 采用优质55CR-Ni材质锻造, 剪切锋利, 耐用
- 手柄采用双色PP+TPR材质, 握感舒适
- 钳体采用内置弹簧结构, 使用便捷, 可用于高强度流水线作业
- 省力偏心结构, 较普通迷你钳明显省力
- Drop Forged with high quality Cr-Ni, durable and longer using life
- Double color with PP+TPR handle, comfortable foe holding
- Labour-saving spring structure can be used for high strength assembly line operations
- Eccentric shaft design, saving effort than ordinary mini pliers

升级

Item no.	Size	L(mm)	
S035044	5.5"	140	6

5合1多功能尖嘴电工钳
5-in-1 multifunctional nipper pliers

- 整体优质Cr-V钢锻造
- 精密剥线, 不损伤内芯
- 锋利剪切
- 铰刀式毛刺修复齿, 轻松除毛刺
- 钳口开合自如, 带锁紧装置
- 轻松压接10-22AWG非绝缘端子
- Chrome-vanadium steel
- Precision stripping, does not damage the inner core
- Sharp shear
- Repair of tooth type burr reamer
- The jaw severed, with locking device
- Easy to press 10-22AWG non insulation terminal

新品

Item no.	Size	Capacity	
S035057	8"	单股10,12,14,18AWG	12
		多股12,14,16,20 AWG	

省力型迷你斜嘴钳5.5"
Mini Diagonal Pliers

- 采用优质55CR-Ni材质锻造, 剪切锋利, 耐用
- 手柄采用双色PP+TPR材质, 握感舒适
- 钳体采用内置弹簧结构, 使用便捷, 可用于高强度流水线作业
- 省力偏心结构, 较普通迷你钳明显省力
- Drop Forged with high quality Cr-Ni, durable and longer using life
- Double color with PP+TPR handle, comfortable foe holding
- Labour-saving spring structure can be used for high strength assembly line operations
- Eccentric shaft design, saving effort than ordinary mini pliers

升级

Item no.	Size	Capacity(mm)	刃口硬度	
S035042	5.5"	铜丝 \leq 1.5	HRC56~62	6
		铁丝 \leq 1.5		
		硬钢丝 \leq 1.2		

省力型迷你扁嘴钳5.5"
Mini Flat Nose Pliers

- 采用优质55CR-Ni材质锻造, 剪切锋利, 耐用
- 手柄采用双色PP+TPR材质, 握感舒适
- 钳体采用内置弹簧结构, 使用便捷, 可用于高强度流水线作业
- 省力偏心结构, 较普通迷你钳明显省力
- Drop Forged with high quality Cr-Ni, durable and longer using life
- Double color with PP+TPR handle, comfortable foe holding
- Labour-saving spring structure can be used for high strength assembly line operations
- Eccentric shaft design, saving effort than ordinary mini pliers

升级

Item no.	Size	L(mm)	
S035045	5.5"	140	6

剥线钳
Wire Stripper

- 刃口可调整, 剥线范围为0.5-4mm
- 也可用于剪线、弯线
- 双沾握手柄, 握持舒适
- Adjustable blades from 0.5-4mm
- Easy to bend, shape, and pull wire
- Double dipped grip handle

升级

Item no.	Size	L(mm)	
S035007	5"	122	12

双色麻柄压线钳
Wire Stripper

- 可剥绝缘材料
- 可压线、剪线
- 可剪螺丝, 平整工件
- 沾握手柄握持舒适
- Crimps insulated terminals
- Easily cuts and strips wire
- Cleanly shears bolts
- Double dipped grip handle for comfort



Item no.	Size	L(mm)	
S035008	8"	205	6

双色柄压线钳

Wire Stripper

- 可剥绝缘材料
- 可压线、剪线
- 可剪螺丝，平整工件
- 沾塑手柄握持舒适
- Crimps insulated terminals
- Easily cuts and strips wire
- Cleanly shears bolts
- Double dipped grip handle



Item no.	Size	L(mm)	
S035009	8"	200	6

鹰嘴万用剥线钳

Wire Stripper

- 剥线范围: 直径0.2 - 6 mm的单股线或排线
- 剥线长度: 最大到25mm (1")
- 手柄握持舒适
- 剥线剪线2合1
- Cable cutter with wire stripper
- Capacity: 0.2 - 6 mm
- Length of strip: up to 25mm (1")
- Metal frame, comfort grip handle

升级



Item no.	Capacity	L(mm)	
S035050	0.2-6mm	168	6

6"带刃口剥线钳

Wire Stripper

- 专业剥皮剪线
- 轻松剥皮，并可剪螺丝
- 可理线、弯线
- 刻度清晰，便于操作
- 带弹簧手柄，操作更便捷
- Crimps insulated terminals
- Easily cuts and strips wire
- Cleanly shears bolts
- Easy-to-read gauge markings
- Wire looping and bending holes
- Spring loaded for self-opening action



Item no.	Capacity	L(mm)	
S035015	26, 24, 22, 20, 18, 16, AWG (0.4, 0.5, 0.6, 0.8, 1.0, 1.3mm)	150	6

套装压线钳

Crimping Tool Set

- 含多种常用配件
- 可剥绝缘材料
- 可压线、剪线
- 可剪螺丝，平整工件
- 压线钳手柄握持舒适
- Handy assortment accessories set for electrical repair
- Crimps insulated terminals
- Easily cuts and strips wire
- Cleanly shears bolts
- Comfort grip handle



Item no.	Size	L(mm)	
S035010	8"	200	6

8"带刃口剥线钳

Wire Stripper

- 专业剥皮剪线
- 轻松剥皮，并可剪螺丝
- 可理线、弯线
- 刻度清晰，便于操作
- Easily cuts and strips wire
- Cleanly shears bolts
- Easy-to-read gauge markings
- Wire looping and bending holes



Item no.	Capacity	L(mm)	
S035013	20, 18, 16, 14, 12, 10 AWG (0.8, 1.0, 1.3, 1.6, 2.0, 2.6 mm)	200	6

强力端子压接钳

Crimping Tool

- 高精度端子压接孔，适度压紧端子于电线上而不损伤端子
- 独特钳头压紧设计，方便各种端子使用
- 手柄握持舒适
- Professional quality crimping tool for non-insulated terminals
- Hardened steel for durability
- Comfort grip handle



Item no.	Capacity	L(mm)	
S035016	1.25, 2.0, 5.5, 8, 16mm ²	285	6
S035017	1.25, 2.0, 5.5, 8.0mm ²	285	6
S035018	5.5, 8.0, 14, 22mm ²	355	6

自动剥线钳

Automatic Wire Stripper

- 精确剥线，不损伤导线
- 剥线能力: 1-3.2mm, 剥离长度24mm
- 钳口开合自如，一步操作即可完成剥皮撕离作业
- 使用刻度盘来调节刀口，以便剥离不同厚度的绝缘层
- 手柄握持舒适
- Wire is automatically gripped and stripped with the same motion
- Capacity: 15-8 AWG(1-3.2mm), strips up to 24mm
- No nicking, cutting or fraying wire
- Comfort grip handle
- Adjustable dial



Item no.	Capacity	L(mm)	
S035011	1.0, 1.6, 2.0, 2.6, 3.2mm	168	6

6"带刃口剥线钳

Wire Stripper

- 专业剥皮剪线
- 轻松剥皮，并可剪螺丝
- 可理线、弯线
- 刻度清晰，便于操作
- 带弹簧手柄，操作更便捷
- Easily cuts and strips wire
- Cleanly shears bolts
- Easy-to-read gauge markings
- Wire looping and bending holes
- Spring loaded for self-opening action



Item no.	Capacity	L(mm)	
S035014	22, 20, 18, 16, 14, 12, 10AWG (0.6, 0.8, 1.0, 1.3, 1.6, 2.0, 2.6mm)	150	6

电讯接头压接钳

Modular Crimping Tool

- 高精度端子压接孔，适度压紧端子于电线上而不损伤端子
- 独特钳头压紧设计，方便各种端子使用，可以压接、剪线、剥皮三用
- 采用优质钢板制造，经久耐用
- 根据人体工程学设计的双色PP+TPR套柄，使用更舒适
- Professional crimping tool for non-insulated terminals
- Capacity: 6P6C 6P4C 6P2C 8P8C 8P6C 8P4C 8P2C
- Comfort bi-material grip handle
- Hardened steel for durability
- Crimping tool with stripper



Item no.	Capacity	L(mm)	
S035019	6P6C 6P4C 6P2C 8P8C 8P6C 8P4C 8P2C	200	6

绝缘端子压接钳

Crimping Tool For Insulated Terminals

- 用于压接绝缘端子, 高精度端子压接孔, 适度压紧端子于电线上而不损坏端子
- 压力调整钮设计, 方便各种端子使用, 独特压紧手柄即可张开钳口设计
- 采用优质钢板制造, 经久耐用
- 符合人体工程学设计的双色PP+TPR套柄, 使用更舒适
- Professional quality crimping tool for insulated terminals
- Comfort bi-material grip handle
- Adjustable thumb-screw dial
- Hardened steel for durability



压接形状:



Item no.	Capacity	L(mm)	
S035022	22-18,16-14,12-10 AWG (0.5-1.0,1.5-2.5,4-6mm ²)	230	6

欧式端子压接钳

Crimping Tool for Non-Insulated Terminals

- 高精度端子压接孔, 适度压紧端子于电线上而不损坏端子
- 压力调整钮设计, 方便各种端子使用, 独特压紧手柄即可张开钳口设计
- 采用优质钢板制造, 经久耐用
- 符合人体工程学设计的双色PP+TPR套柄, 使用更舒适
- Professional quality crimping tool for non-insulated terminals
- Adjustable thumb-screw dial
- Hardened steel for durability
- Comfort bi-material grip handle



压接形状:



Item no.	Capacity	L(mm)	
S035025	22, 20, 18, 16, 14, 12AWG (0.5, 0.75, 1.0, 1.5, 2.5, 4.0mm ²)	230	6
S035026	22-20, 18-16, 14, 12, 10AWG (0.5-0.75, 1.0-1.5, 2.5, 4.0, 6.0mm ²)	230	6

连续端子压接钳

Crimping Tool for Non-Insulated Terminals

- 高精度端子压接孔, 适度压紧端子于电线上而不损坏端子
- 压力调整钮设计, 方便各种端子使用, 独特压紧手柄即可张开钳口设计
- 采用优质钢板制造, 经久耐用
- 符合人体工程学设计的双色PP+TPR套柄, 使用更舒适
- Professional quality crimping tool for non-insulated terminals
- Adjustable thumb-screw dial
- Hardened steel for durability
- Comfort bi-material grip handle



压接形状:



Item no.	Capacity	L(mm)	
S035023	20-18,16-14,12-10AWG (1.5,2.5,6mm ²)	230	6

同轴端子压接钳

Crimping Tool For Non-Insulated Terminals

- 高精度端子压接孔, 适度压紧端子于电线上而不损坏端子。
- 压力调整钮设计, 方便各种端子使用, 独特压紧手柄即可张开钳口设计。
- 采用优质钢板制造, 经久耐用。
- 符合人体工程学设计的双色PP+TPR套柄, 使用更舒适。
- Professional quality crimping tool for non-insulated terminals
- Adjustable thumb-screw dial
- Hardened steel for durability
- Comfort bi-material grip handle



压接形状:



Item no.	Capacity	L(mm)	
S035027	15,13,10,9,8AWG (1.72, 2.54, 5.41, 6.48, 8.23mm ²)	230	6

裸端子压接钳

Crimping Tool for Non-Insulated Terminals

- 高精度端子压接孔, 适度压紧端子于电线上而不损坏端子
- 压力调整钮设计, 方便各种端子使用, 独特压紧手柄即可张开钳口设计
- 采用优质钢板制造, 经久耐用
- 符合人体工程学设计的双色PP+TPR套柄, 使用更舒适
- Professional quality crimping tool for non-insulated terminals
- Adjustable thumb-screw dial
- Hardened steel for durability
- Comfort bi-material grip handle



压接形状:



Item no.	Capacity	L(mm)	
S035024	20-18,16-14,12-10,8AWG (1.5,2.5,6,10mm ²)	230	6

6"手动电缆钳

Cable Cutter

- 刃口坚韧锋利, 持久耐用
- 锯齿状刃口, 剪切有力平整
- 可切割多股铜、铝芯电缆, 不适合剪铁丝、钢芯电缆等
- 双沾塑手柄, 握持舒适
- Hardened steel cutting blades for lasting
- For quick & easy copper and aluminum, not suitable for wire and steel-core cable cutting
- Double dipped grip handle
- strength and sharpness
- Serrated jaws
- cables cutting



Item no.	Capacity	L(mm)	
S035028	22mm ²	150	6

10"手动电缆钳

Cable Cutter

- 刃口坚韧锋利, 持久耐用
- 锯齿状刃口, 剪切有力平整
- 可切割多股铜、铝芯电缆, 不适合剪铁丝、钢芯电缆等
- 双沾塑手柄, 握持舒适
- Hardened steel cutting blades for lasting
- For quick & easy copper and aluminum, not suitable for wire and steel-core cable cutting
- Double dipped grip handle
- strength and sharpness
- Serrated jaws
- cables cutting



Item no.	Capacity	L(mm)	
S035029	60mm ²	240	6

手动电缆剪

Cable Cutter

- 刃口坚韧锋利, 持久耐用
- 锯齿状刃口, 剪切有力平整
- 可切割多股铜、铝芯电缆, 不适合剪铁丝、钢芯电缆等
- 手柄舒适
- Hardened steel cutting blades for lasting
- strength and sharpness
- Serrated jaws
- For quick & easy copper and aluminum cables cutting
- Steel handles with rubber grips

CR-MO 升级

Item no.	Size	Capacity	L(mm)	
S035031	18"	180mm ²	455	1
S035032	24"	250mm ²	600	1

铝合金手动电缆剪

Cable Cutter

- 刃口坚韧锋利, 持久耐用
- 锯齿状刃口, 剪切有力平整
- 可切割多股铜、铝芯电缆, 不适合剪铁丝、钢芯电缆等
- 铝合金钳身, 轻便耐用
- Hardened steel cutting blades for lasting
- For quick & easy copper and aluminum, not suitable for wire and steel-core cable cutting
- Double dipped grip handle
- strength and sharpness
- Serrated jaws
- cables cutting

CR-MO 升级

Item no.	Size	Capacity	L(mm)	
S035033	24"	325mm ²	455	1



套装类、手电筒、万用表、测电类、镊子、电工电子钳、电缆剪、电工剪刀、精密螺丝批、电烙铁及配件

棘轮式手动电缆剪

Ratcheting Cable Cutter

- 刃口坚韧锋利，持久耐用
 - 采用棘轮结构，有自锁功能，剪切更省力
 - Hardened steel cutting blades for lasting
 - Strength and sharpness
 - Ratchet-type jaws with shear-cut blades
 - For quick & easy copper and aluminum cables cutting
 - Steel handles with rubber grips
- ▲可切割多股铜、铝芯电缆，不适合剪铁丝、钢芯电缆等



Item no.	Size	Capacity	L(mm)	
S035034	10"	240mm ²	250	1
S035035	12.5"	400mm ²	320	1

电工剪

Electrician's Shear

- 采用优质合金钢制造
- 刃口坚韧锋利，持久耐用
- 凹槽便于剪切电缆
- 手柄握持舒适，抗溶解
- High alloy carbon steel, hardened
- Sturdy model, straight, very robust, micro-toothed cutting
- With cable notch
- Soft vinyl grip handles are oil and solvent resistant



Item no.	Size	L(mm)	
S036010	6"	150	12

塑柄直刃电工刀

Plastic Handle Cable Knife (Guard)

- 采用优质不锈钢材质，经特殊热处理加工双色
- PP+TPR手柄，握持舒适
- High-grade stainless steel, heat treated
- Bi-color soft grip handle for comfort

新品



Item no.	D(mm)	L(mm)	
S036003	40	160	30

钢索剪

Wire Rope Cutter

- 钳头采用优质钢材锻造，整体热处理
- 可剪钢丝绳、电缆等
- 双沾塑手柄，握持舒适
- Drop forged steel blade, heat treated
- Used to cut wire rope, steel wire, cable, etc
- Double dipped grip handle with comfort



Item no.	Size	Capacity	L(mm)	
S035036	8"	铁丝 3/16"(4.8mm) 弹簧 1/16"(1.6mm)	200	6

直刃电工刀

Electrician's Knife

- 采用特殊硬质钢材，经特殊热处理
- 刃口硬度大于HRC54
- 彩木柄，美观耐用
- Heat treated and tempered steel blade
- Hardened blade to HRC54
- Comfortable wood handle



Item no.	Size	L(mm)	
S036001	8"	205	10

多功能弯刃电缆剥刀

Multifunctional cable cutting knife

- 刀片采用优质钢材加工，锋利耐磨
- 弹簧及推钮采用铝合金材质，重量轻，便于携带
- 弹力压线方式，不须调整孔径大小，可适合不同绝缘厚度的线材剥线
- Razor-sharp tempered blade
- Aluminum alloy Spring and push button
- Suitable for different thickness of the insulation wire stripping

新品



Item no.	Capacity	L(mm)	
S036004	8-28mm	180	12

铝柄钢索剪

Wire Rope Cutter

- 钳头采用优质钢材锻造，整体热处理
- 可剪铁丝、钢索、电缆等
- 铝合金钳身，轻便耐用
- Drop forged steel blade, heat treated
- Used to cut steel and stainless steel wire rope
- Aluminum handles with rubber grips



Item no.	Size	Capacity	L(mm)	
S035037	24"	铁丝 9mm 钢索 12mm 电缆 150mm ²	600	1

弯刃电工刀

Electrician's Knife

- 采用特殊硬质钢材，经特殊热处理
- 刃口硬度大于HRC54
- 彩木柄，美观耐用
- Heat treated and tempered steel blade
- Hardened blade to HRC54
- Colorful wood handle, attractive & durable



Item no.	Size	L(mm)	
S036002	8"	200	10

6件套精密螺丝刀

6Pc Precision Screwdriver Set

- 适于钟表、眼镜及各种精密仪器的维护和修理
- 采用旋转式旋帽设计
- 手柄采用聚丙烯材料，握持舒适
- Swivel-head handles provide precision and reach
- Tough plastic shaft with soft cushion grip ensure greater comfort
- Ideal for precision equipment maintenance & fix



Item no.	
S037001	12
2件：十字：#0, #1	
4件：一字：1.4mm, 2.0mm, 2.4mm, 3.0mm	

6件套金属精密螺丝刀

6Pc Precision Screwdriver Set

- 采用旋转式旋帽设计
- 适于钟表、眼镜及各种精密仪器的维护和修理
- Swivel-head handles provide precision & fix
- Ideal for precision equipment maintenance



Item no.	Icon	Count
S037002		12
2件：十字：#0, #1		
4件：一字：1mm, 1.4mm, 1.8mm, 2.4mm		

双色柄十字精密螺丝刀

Precision Screwdriver Phillips

- 刀杆采用S2材质，雾面镀铬处理
- 刀杆头部采用特殊加硬发黑处理
- 双色PP+TPR手柄，尾部转动盖设计，握持舒适，可单手操作
- S2 blade, matte chrome plated
- Entirely hardened, black tip
- Bi-color PP+TPR molded handle, spinning endcap



Item no.	Size(mm)	L(mm)	Icon
S037111	PH000x50	142	12
S037112	PH00x50	142	12
S037113	PH0x50	142	12
S037114	PH1x50	142	12
S037116	PH00X75	142	12

6件套双色柄精密螺丝刀组套

6Pc Precision Screwdriver Set

- 刀杆采用S2材质，雾面镀铬处理
- 刀杆头部采用特殊加硬发黑处理
- 双色PP+TPR手柄，尾部转动盖设计，握持舒适，可单手操作
- S2 blade, matte chrome plated
- Entirely hardened, black tip
- Bi-color PP+TPR molded handle, spinning endcap



Item no.	Icon	Count
S037007		6
4件 一字：1.4x50、2.0x50、2.5x50、3.0x50mm		
2件 十字：PH00x 50、PH0x50mm		

8合1铝合金手柄钟表螺丝刀

8-in-1 Precision Screwdriver Set

- 采用旋转式旋帽设计
- 手柄采用铝合金材料，握持舒适
- 适于钟表、眼镜及各种精密仪器的维护和修理
- Swivel-head handles provide precision and reach
- Aluminum handles with soft cushion grip ensure greater comfort
- Ideal for precision equipment maintenance & fix



Item no.	Icon	Count
S037003		6
4件：十字：#1, #0, #00, #000		
4件：一字：1.5, 2.0, 2.5, 3.0mm		

双色柄六角精密螺丝刀

Precision Screwdriver Hex Key

- 刀杆采用S2材质，雾面镀铬处理
- 刀杆头部采用特殊加硬发黑处理
- 双色PP+TPR手柄，尾部转动盖设计，握持舒适，可单手操作
- S2 blade, chrome plated
- Entirely hardened, black tip
- Bi-color PP+TPR molded handle, spinning endcap



Item no.	Size(mm)	L(mm)	Icon
S037121	0.9x50	142	12
S037122	1.3x50	142	12
S037123	1.5x50	142	12
S037124	2.0x50	142	12

7件套双色柄精密螺丝刀组套

7Pc Precision Screwdriver Set

- 刀杆采用S2材质，雾面镀铬处理
- 刀杆头部采用特殊加硬发黑处理
- 双色PP+TPR手柄，尾部转动盖设计，握持舒适，可单手操作
- S2 blade, chrome plated
- Entirely hardened, black tip
- Bi-material molded handle, spinning endcap



Item no.	Icon	Count
S037008		6
4件 一字：1.4 x 50, 2.0 x 50, 2.5 x 50, 3.0 x 50mm		
3件 十字：PH000 x 50, PH00 x 50, PH0 x 50mm		

双色柄一字精密螺丝刀

Precision Screwdriver Slotted

- 刀杆采用S2材质，雾面镀铬处理
- 刀杆头部采用特殊加硬发黑处理
- 双色PP+TPR手柄，尾部转动盖设计，握持舒适，可单手操作
- S2 blade, matte chrome plated
- Entirely hardened, black tip
- Bi-material molded handle, spinning endcap



Item no.	Size(mm)	L(mm)	Icon
S037101	1.0x50	142	12
S037102	1.4x50	142	12
S037103	1.6x50	142	12
S037104	2.0x50	142	12
S037105	2.5x50	142	12
S037106	3.0x50	142	12
S037107	2.0x75	169	12
S037108	3.5x50	142	12

双色柄花型精密螺丝刀

Precision Screwdriver Torx

- 刀杆采用S2材质，雾面镀铬处理
- 刀杆头部采用特殊加硬发黑处理
- 双色PP+TPR手柄，尾部转动盖设计，握持舒适，可单手操作
- S2 blade, chrome plated
- Entirely hardened, black tip
- Bi-material molded handle, spinning endcap



Item no.	Size(mm)	L(mm)	Icon
S037125	T3x50	142	12
S037126	T4x50	142	12
S037127	T5x50	142	12
S037128	T6x50	142	12

15件套双色柄精密螺丝刀组套

15Pc Precision Set

- 刀杆采用S2材质，雾面镀铬处理
- 刀杆头部采用特殊加硬发黑处理
- 双色PP+TPR手柄，尾部转动盖设计，握持舒适，可单手操作
- S2 blade, matte chrome plated
- Entirely hardened, black tip
- Bi-color PP&TPR molded handle, spinning endcap



Item no.	Icon	Count
S037015		6
4件 一字：1.0x50、2.0x50、3.0x50、3.5x50mm		
3件 十字：PH000x50、PH00x50、PH0x50mm		
4件 花型：T3x50、T4x50、T5x50、T6x50mm		
4件 六角：0.9x50、1.3x50、1.5x50、2.0x50mm		

6合1多用螺丝批

6-In-1 Screwdriver Set

- 刀杆采用优质CR-V-MO材质，雾面镀铬处理，美观耐用
- 双色PP+TPR耐油手柄，握持舒适
- Chrome Vanadium Molybdenum steel blade, chrome plated
- PP&TPR comfort anti-slip grip handle

CR-V-MO



Item no.

S037004

12

一字：2.0, 3.0, 4.0

十字：PH00, PH0, PH1

筒装焊锡丝

Rosin Core Solder

- 适于各种电子电工类的焊锡作业
- 不易生锈，绝缘
- 可快速焊锡，融结性良好
- 融解温度：182°C - 190°C (360°F - 375°F)
- 成分：60%锡，40%铅
- Designed for electrical & electronic work, flux residue
- Non-corrosive & non-conductive
- Fast soldering, long lasting bond
- Melting Point: 360°F - 375°F (182°C - 190°C)
- Component: 60% Tin & 40% Lead



Item no.

S038037

Size

10g

5

防静电刷子

ESD Brush

- 用于清洁电子零部件及相关产品表面，去除产品表面静电
- Ideal for cleaning electronic components, removing static electricity



Item no.

S038047

Size(mm)

175

12

12合1多用螺丝批

12-In-1 Screwdriver Set

- 刀杆采用优质S2材质，雾面镀铬处理，美观耐用
- 双色PP+TPR耐油手柄，握持舒适
- S2 blade, matte chrome plated
- PP&TPR comfort anti-slip grip handle

S2



Item no.

S037005

12

一字：1.5, 2.5

花型：T4, T5, T6, T7, T8, T10

十字：PH00, PH0

六角：H1.5, H2.0

全铝吸锡器

Desoldering Pump

- 采用优质铝材，吸嘴防静电，耐高温
- 带弹簧活塞装置，去除焊锡更快速方便
- 吸嘴可更换
- Aluminum body and anti-static, heat-resistant tip
- Spring loaded piston quickly removed solder from circuit board
- Replaceable tip



Item no.

S038038

Size(mm)

202

12

六件套助焊工具

6Pc Soldering Kit

- 六件套助焊工具可广泛的应用于印刷电路板 (PCB) 的焊接组装和维修作业，形状各异的端子可实现下列功能：
- 元件定位端子：可以方便地调整表面贴装元器件的引脚，在焊盘或金手指上的位置。
- 弯针：可用来调整贴片IC, PLCC等元器件的引脚。
- 钩子：可以钩出元器件的引脚和导线。
- 叉子：固定或调整元件的引脚和连接线。
- 锥子：清洁或扩大焊盘的孔。
- 刮刀：去除残留的焊锡和助焊剂，清除焊盘或金手指上的氧化层。
- 刀：可切割印刷电路板上的敷铜连线。
- 刷子：焊接前清洁被焊接部位的粉尘和残留物。



Item no.

S038041

Size(mm)

180

12

外热式电烙铁

Electric Iron

- 220V, 50Hz
- 长寿命电烙铁头，可更换发热芯
- 手柄握持舒适安全
- 220V, 50Hz
- Long life replaceable tip heating core
- Impact resistance handle

升级



Item no.

S038010

Voltage

220V

Power

30W

6

S038011

220V

40W

6

S038012

220V

50W

6

S038013

220V

60W

6

PLCC起拔器

PLCC Extractor

- 适合拆装PLCC元器件
- 金属件采用耐酸不锈钢
- 可起拔PLCC的尺寸：20-84针脚
- Perfect for removing and installing PLCC chips
- Stainless steel, Anti-acid
- PLCC size: 20-84 pin



Item no.

S038039

Capacity

20-84 针脚

12

电工绝缘胶带

Electrical Tape

- 19mm 宽, 9m长
- 通过UL认证
- 19mm x 9m
- UL Listed



Item no.

S038042

Size

19mm x 9m

Color

Black (黑色)

50

S038043

19mm x 9m

Red (红色)

50

S038044

19mm x 9m

Yellow (黄色)

50

S038045

19mm x 9m

Green (绿色)

50

双重防静电手柄斜嘴钳5"
5" Double anti-static handle diagonal cutting pliers

- 手柄采用防静电TPE材料制作, 适用于特殊要求防静电工作场合
- 最大剪切线径: $\leq 1.3\text{mm}$, 防静电范围: 防静电电阻 $10^6 - 10^{11}$
- 钳体厚度2.5mm, 表面采用防静电特氟龙处理
- 请勿剪切钢线和铁线
- Anti-static TPE handle, suitable for workplace requiring anti-static safety Max.wire gauges 1.3mm , Anti-static range. Anti-static resistance $10^6 - 10^{11}$
- Body thickness : 2.5mm with anti-static teflon treatment.
- Do not cut steel wire & iron wire.



Item no.	Size	L(mm)	
S170001	5"	125	6

重型防静电手柄斜嘴钳5"
5" Heavy-duty anti-static handle diagonal cutting pliers

- 手柄采用防静电TPE材料制作, 适用于特殊要求防静电工作场合
- 最大剪切线径: $\leq 1.6\text{mm}$, 防静电范围: 防静电电阻 $10^6 - 10^{11}$
- 钳体厚度3.0mm, 表面采用防静电特氟龙处理
- 请勿剪切钢线和铁线
- Anti-static TPE handle, suitable for workplace requiring anti-static safety Max.wire gauges 1.6mm , Anti-static range. Anti-static resistance $10^6 - 10^{11}$
- Body thickness : 3.0mm with anti-static teflon treatment.
- Do not cut steel wire & iron wire.



Item no.	Size	L(mm)	
S170002	5"	125	6

双重防静电手柄安全挡片斜嘴钳5"
5" Double anti-static handle diagonal cutting pliers with lock

- 手柄采用防静电TPE材料制作, 适用于特殊要求防静电工作场合
- 最大剪切线径: $\leq 1.3\text{mm}$, 防静电范围: 防静电电阻 $10^6 - 10^{11}$
- 钳体厚度2.5mm, 表面采用防静电特氟龙处理
- 细形刀口带安全挡片
- 请勿剪切钢线和铁线
- Anti-static TPE handle, suitable for workplace requiring anti-static safety Max.wire gauges 1.3mm , Anti-static range. Anti-static resistance $10^6 - 10^{11}$
- Designed with lock to ensure security
- Body thickness : 2.5mm with anti-static teflon treatment.



Item no.	Size	L(mm)	
S170003	5"	125	6

双重防静电手柄尖嘴钳5"
5" Double anti-static handle needle-nose pliers

- 手柄采用防静电TPE材料制作, 适用于特殊要求防静电工作场合
- 最大剪切线径: $\leq 1.3\text{mm}$, 防静电范围: 防静电电阻 $10^6 - 10^{11}$
- 钳体厚度2.5mm, 表面采用防静电特氟龙处理
- 细形刀口带安全挡片
- 请勿剪切钢线和铁线
- Anti-static TPE handle, suitable for workplace requiring anti-static safety
- Max.wire gauges 1.3mm , Anti-static range. Anti-static resistance $10^6 - 10^{11}$
- Body thickness : 2.5mm with anti-static teflon treatment with lock to ensure security
- Do not cut steel/iron wire



Item no.	Size	L(mm)	
S170004	5"	125	6

防静电碳纤维尖头镊子
Anti-static carbon fiber tip tweezers

- 采用优质不锈钢材质制造, 可持久保持镊体弹性
- 头部采用碳纤维材质, 高弹性, 韧性好, 耐腐蚀
- 适用于特殊要求防静电工作场合
- Made from high quality stainless steel to keep the tweezers flexible
- The head part of tweezers made from carbon fiber material, flexible and anti-corrosion
- Suitable for workplace requiring anti-static safety



Item no.	L(mm)	
S170011	130	12

防静电碳纤维宽头镊子
Anti-static carbon fiber tip tweezers

- 采用优质不锈钢材质制造, 可持久保持镊体弹性
- 头部采用碳纤维材质, 高弹性, 韧性好, 耐腐蚀
- 适用于特殊要求防静电工作场合
- Made from high quality stainless steel to keep the tweezers flexible
- The head part of tweezers made from carbon fiber material, flexible and anti-corrosion
- Suitable for workplace requiring anti-static safety



Item no.	L(mm)	
S170012	130	12

防静电碳纤维弯头镊子
Anti-static carbon fiber bend-nose tweezers

- 采用优质不锈钢材质制造, 可持久保持镊体弹性
- 头部采用碳纤维材质, 高弹性, 韧性好, 耐腐蚀
- 适用于特殊要求防静电工作场合
- Made from high quality stainless steel to keep the tweezers flexible
- The head part of tweezers made from carbon fiber material, flexible and anti-corrosion
- Suitable for workplace requiring anti-static safety



Item no.	L(mm)	
S170013	130	12

防静电酒精瓶
Alcohol Bottle

- 瓶口采用独特不锈钢泵, 单手即可操作
- 瓶身采用高密度聚乙烯材料, 可盛放各种清洁剂、去油剂、乙醇、甲醇、丙酮等溶剂
- 带精密阀门的不锈钢泵头, 防止溶剂挥发和侵蚀
- 不锈钢盖带铰链, 可防止杂物污染瓶口
- One-handed operating pump top bottle
- Made of molded polyethylene and will not react with such solvents as TCE or alcohol
- Stainless steel one-touch pump with an airtight valve for volatilization-resistance and corrosion-resistance
- Stainless steel lid with hinge



Item no.	Capacity(ml)	
S038048	150	12

可调试防静电手腕带
Anti-Static Wrist Strap

- 手带柔软有弹性
- 手带长度可调, 带鳄鱼夹
- 使用时手带戴在手腕上, 鳄鱼夹夹在地线上, 可快速消除静电, 防止损坏电子零部件
- Soft elastic band for comfort
- Adjustable wrist strap with alligator clip tip
- Simply wrap strap around wrist and clip to a grounded source, prevent static shock in dry environment keep static from damaging electronic parts and equipments



Item no.	Size(mm)	Test	
S038046	150	100V-500V	12

套装类、手电筒、万用表、测电类、镊子、电工电子钳、电缆剪、电工剪刀、精密螺丝批、电烙铁及附件



VDE绝缘类工具 **VDE Insulated Tools**

套装类、螺丝批、钳类、扳手、套筒、电工刀、锯架、线夹及镊子
Tool Set, Screwdriver, Pliers, Wrenches, Sockets, Electrician's Knife, Saws, Nose Plier and Tweezer

66件套新能源汽车维修工具箱组套

66pc maintain tool set cabinet for new source vehicle

- 通过VDE认证和10000V高压测试，耐压1000V
- 优质CR-V材质整体锻造
- 手柄特殊保护处理，使用安全
- VDE approved Insulated voltage range:0-1000V by 10000V high voltage test
- High-grade forged CR-V steel
- Special protection treatment for handles to guarantee security



Item no.	LXWXH(mm)	
S158023	676X459X1021	1
10件 12.5mm系列绝缘公制六角套筒10、11、12、13、14、16、17、19、22、24mm		
5件 12.5mm系列绝缘公制六角旋具套筒4、5、6、8、10mm		
1件 12.5mm系列双色柄绝缘双向棘轮扳手		
1件 12.5mm系列双色柄绝缘T性套筒扳手		
2件 12.5mm系列绝缘套筒加长接杆5'、10'		
7件 10mm系列绝缘公制六角套筒10、12、13、14、16、17、18mm		
1件 10mm系列双色柄绝缘双向棘轮扳手		
2件 10mm系列绝缘套筒加长接杆5'、10'		
6件 双色绝缘螺丝批 一字：2.5x75mm、4x100mm、5.5x125mm；十字：PH0x75mm、PH1x75mm、PH2x100mm		
13件 双色柄绝缘开口扳手		
13件 双色柄绝缘梅花扳手		
1件 双色柄绝缘斜嘴钳8"		
1件 双色柄绝缘钢丝钳8"		
1件 双色柄绝缘尖嘴钳8"		
1件 双色柄绝缘活动扳手8"		
1件 注塑型双色绝缘护套式直平型电缆刀50x180mm		



66件套新能源汽车维修工具箱组套

66pc maintain tool set box for new source vehicle

- 通过VDE认证和10000V高压测试，耐压1000V
- 优质CR-V材质整体锻造
- 手柄特殊保护处理，使用安全
- VDE approved Insulated voltage range:0-1000V by 10000V high voltage test
- High-grade forged CR-V steel
- Special protection treatment for handles to guarantee security

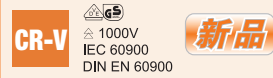

Item no.	LXWXH(mm)	
S158022	480x380x190	1
10件 12.5mm系列绝缘公制六角套筒10、11、12、13、14、16、17、19、22、24mm		
5件 12.5mm系列绝缘公制六角旋具套筒4、5、6、8、10mm		
1件 12.5mm系列双色柄绝缘双向棘轮扳手		
1件 12.5mm系列双色柄绝缘T性套筒扳手		
2件 12.5mm系列绝缘套筒加长接杆5'、10'		
7件 10mm系列绝缘公制六角套筒10、12、13、14、16、17、18mm		
1件 10mm系列双色柄绝缘双向棘轮扳手		
2件 10mm系列绝缘套筒加长接杆5'、10'		
6件 双色绝缘螺丝批 一字：2.5x75mm、4x100mm、5.5x125mm；十字：PH0x75mm、PH1x75mm、PH2x100mm		
13件 双色柄绝缘开口扳手		
13件 双色柄绝缘梅花扳手		
1件 双色柄绝缘斜嘴钳8"		
1件 双色柄绝缘钢丝钳8"		
1件 双色柄绝缘尖嘴钳8"		
1件 双色柄绝缘活动扳手8"		
1件 注塑型双色绝缘护套式直平型电缆刀50x180mm		



套装类、螺丝批、钳类、扳手、套筒、电刀、锯架、线夹及镊子

20件套12.5mm系列绝缘套筒组套

20pc 12.5mm Series Isolate Sleeves Set

- 通过VDE认证和10000V高压测试，耐压1000V
- 优质CR-V材质整体锻造
- 手柄特殊保护处理，使用安全
- VDE approved Insulated voltage range:0-1000V, by 10000V high voltage test
- High-grade forged CR-V steel
- Special protection treatment for handles to guarantee security



Item no.	LXWXH(mm)	↑
S158021	460x330x100	1
12件 12.5mm系列绝缘公制六角套筒10、11、12、13、14、17、19、22、24、27、30、32mm		
4件 12.5mm系列绝缘公制六角旋具套筒4、5、6、8mm		
1件 12.5mm系列双色柄绝缘双向棘轮扳手		
1件 12.5mm系列双色柄绝缘T性套筒扳手		
2件 12.5mm系列绝缘套筒加长接杆5"、10"		

19件套综合绝缘组套

19pc VDE Tools Set

- 通过VDE认证和10000V高压测试，耐压1000V
- 优质CR-V材质整体锻造
- 手柄特殊保护处理，使用安全
- VDE approved Insulated voltage range:0-1000V, by 10000V high voltage test
- High-grade forged CR-V steel
- Special protection treatment for handles to guarantee security



Item no.	LXWXH(mm)	↑
S158024	460x330x100	1
3件 绝缘钢丝钳7"、绝缘尖嘴钳6"、绝缘斜嘴钳6"		
7件 一字绝缘螺丝刀3X75mm, 4X100mm, 5.5X125mm, 6.5X150mm, 十字绝缘螺丝刀PH0X75, PH1X80, PH2X100		
6件 绝缘平头六角螺丝批H2.5X75mm, H3X75mm, H4X75mm, H5X75mm, H6X100mm, H8X100mm		
2件 绝缘胶带、绝缘测电笔		
1件 绝缘活动扳手8"		

7件套双色绝缘螺丝批组套

7PC Insulated Screwdriver

- 通过VDE认证和10000V高压测试，耐压1000V
- 优质CR-V材质整体锻造
- 双色PP+TPR手柄，美观舒适
- 刀杆采用优质CR-V材质
- VDE approved Insulated voltage range:0-1000V, by 10000V high voltage test
- Bi-color soft grip handle for comfort
- Chrome vanadium steel blade



Item no.	↑
S057002	1
十字 / Phillips: PH0x75mm, PH1x80mm, PH2x100mm	
一字 / Slotted: 3x75mm, 4x100mm, 5.5x125mm, 6.5x150mm	

双色柄绝缘一字螺丝批

VDE Slotted Screwdriver

- 通过VDE认证和10000V高压测试，耐压1000V
- 优质CR-V材质整体锻造
- 双色PP+TPR手柄，美观舒适
- 刀杆采用优质CR-V材质
- VDE approved Insulated voltage range:0-1000V, by 10000V high voltage test
- Bi-color soft grip handle for comfort
- Chrome vanadium steel blade



Item no.	↑	↑	↑	↑	↑	↑
S057301	0.5	3.0	3.0	75	145	12
S057302	0.8	4.0	4.0	100	190	12
S057303	1.0	5.5	5.5	125	225	12
S057304	1.2	6.5	6.5	150	250	12

双色绝缘十字螺丝刀

Insulated Phillips Serewdriver

- 通过VDE认证和10000V高压测试，耐压1000V
- 优质CR-V材质整体锻造
- 双色PP+TPR手柄，美观舒适
- 刀杆采用优质CR-V材质
- VDE approved Insulated voltage range:0-1000V, by 10000V high voltage test
- Bi-color soft grip handle for comfort
- Chrome vanadium steel blade
- Insulated voltage range:0-1,000V



Item no.	↑	↑	↑	↑	↑
S057401	PH0	3.0	75	145	12
S057402	PH1	5.0	80	168	12
S057403	PH2	6.0	100	200	12
S057404	PH3	8.0	150	250	12

双色柄绝缘米字螺丝批

VDE Pozi Screwdriver

- 通过VDE认证和10000V高压测试，耐压1000V
- 优质CR-V材质整体锻造
- 双色PP+TPR手柄，美观舒适
- 刀杆采用优质CR-V材质
- VDE approved Insulated voltage range:0-1000V, by 10000V high voltage test
- Bi-color soft grip handle for comfort
- Chrome vanadium steel blade



Item no.	↑	↑	↑	↑	↑
S151006	PZ0	3.0	60	95x25	153 12
S151007	PZ1	5.0	80	105x30	200 12
S151008	PZ2	6.0	100	115x35	235 12
S151009	PZ3	8.0	150	115x35	260 12

双色柄绝缘平头六角螺丝批

VDE HEX Screwdriver

- 通过VDE认证和10000V高压测试，耐压1000V
- 优质CR-V材质整体锻造
- 双色PP+TPR手柄，美观舒适
- 刀杆采用优质CR-V材质
- VDE approved Insulated voltage range:0-1000V, by 10000V high voltage test
- Bi-color soft grip handle for comfort
- Chrome vanadium steel blade



Item no.	↑	↑	↑	↑	↑
S151011	H2.5	S2.5	75	95x25	170 12
S151012	H3.0	S3.0	75	95x25	170 12
S151013	H4.0	S4.0	75	105x30	180 12
S151014	H5.0	S5.0	75	105x30	180 12
S151015	H6.0	S6.0	100	115x35	215 12
S151016	H8.0	S8.0	100	115x35	215 12

双色柄绝缘花型螺丝批

VDE Torx Screwdriver

- 通过VDE认证和10000V高压测试，耐压1000V
- 优质CR-V材质整体锻造
- 双色PP+TPR手柄，美观舒适
- 刀杆采用优质CR-V材质
- VDE approved Insulated voltage range:0-1000V, by 10000V high voltage test
- Bi-color soft grip handle for comfort
- Chrome vanadium steel cutter arbor



Item no.	Icon	Icon	Icon	Icon	Icon	Icon
S151001	T10	3.0	70	95x25	165	12
S151002	T15	4.0	80	105x30	185	12
S151003	T20	4.0	100	105x30	205	12
S151004	T25	5.0	125	105x30	230	12
S151005	T30	6.0	130	115x35	245	12

双色柄绝缘带孔螺帽螺丝批

VDE Nut Screwdriver

- 通过VDE认证和10000V高压测试，耐压1000V
- 优质CR-V材质整体锻造
- 双色PP+TPR手柄，美观舒适
- 刀杆采用优质CR-V材质
- VDE approved Insulated voltage range:0-1000V, by 10000V high voltage test
- Bi-color soft grip handle for comfort
- Chrome vanadium steel cutter arbor



Item no.	Icon	Icon	Icon	Icon	Icon	Icon
S151021	4	7.2	125	31	105x30	230 12
S151022	5	7.2	125	31	105x30	230 12
S151023	5.5	7.2	125	31	105x30	230 12
S151024	6	7.2	125	31	105x30	230 12
S151025	7	7.2	125	31	105x30	230 12
S151026	8	7.2	125	31	105x30	230 12
S151027	9	7.2	125	31	105x30	230 12
S151028	10	7.2	125	31	105x30	230 12
S151029	11	8.1	125	31	105x30	230 12
S151030	12	8.1	125	31	105x30	230 12
S151031	13	8.1	125	31	105x30	230 12
S151032	14	8.1	125	31	105x30	230 12

双色柄绝缘十字精密螺丝批

VDE Precision Phillips Screwdriver

- 通过VDE认证和10000V高压测试，耐压1000V
- 优质CR-V材质整体锻造
- 双色PP+TPR手柄，美观舒适
- 刀杆采用优质CR-V材质
- VDE approved Insulated voltage range:0-1000V, by 10000V high voltage test
- Bi-color soft grip handle for comfort
- Chrome vanadium steel cutter arbor



Item no.	Icon	Icon	Icon	Icon	Icon	Icon
S151051	PH00	3.0	50	95x18	145	12
S151052	PH0	3.0	50	95x18	145	12
S151053	PH1	3.0	50	95x18	145	12

双色柄绝缘一字精密螺丝批

VDE Precision Slotted Screwdriver

- 通过VDE认证和10000V高压测试，耐压1000V
- 优质CR-V材质整体锻造
- 双色PP+TPR手柄，美观舒适
- 刀杆采用优质CR-V材质
- VDE approved Insulated voltage range:0-1000V, by 10000V high voltage test
- Bi-color soft grip handle for comfort
- Chrome vanadium steel cutter arbor



Item no.	Icon	Icon	Icon	Icon	Icon	Icon
S151041	0.23	1.5	3.0	50	95x18	145 12
S151042	0.3	1.8	3.0	50	95x18	145 12
S151043	0.4	2.0	3.0	50	95x18	145 12
S151044	0.4	2.5	3.0	50	95x18	145 12
S151045	0.5	3.0	3.0	50	95x18	145 12

双色柄绝缘花型精密螺丝批

VDE Precision Torx Screwdriver

- 通过VDE认证和10000V高压测试，耐压1000V
- 优质CR-V材质整体锻造
- 双色PP+TPR手柄，美观舒适
- 刀杆采用优质CR-V材质
- VDE approved Insulated voltage range:0-1000V, by 10000V high voltage test
- Bi-color soft grip handle for comfort
- Chrome vanadium steel cutter arbor



Item no.	Icon	Icon	Icon	Icon	Icon	Icon
S151061	T6	3.0	50	95x18	145	12
S151062	T8	3.0	50	95x18	145	12
S151063	T10	3.0	50	95x18	145	12
S151064	T15	4.0	50	95x18	145	12
S151065	T20	4.0	50	95x18	145	12

3件套绝缘钳套装

3Pc Insulated Pliers Set

- 通过VDE认证和10000V高压测试，耐压1000V
- 优质CR-V材质整体锻造
- 采用优质铬钒钢锻造，坚固耐用
- 双材料手柄，握持舒适
- 手柄特别保护设计，使用更安全
- VDE approved Insulated voltage range:0-1000V, by 10000V high voltage test
- Chrome-Vanadium steel
- Dual-material comfort grip handle
- Integral guards help prevent hand contact with conductive parts



Item no.	Icon
S046001	6
7" linesman pliers / 7" 绝缘钢丝钳	
7" diagonal pliers / 7" 绝缘斜嘴钳	
8" Long Nose Pliers / 8" 绝缘尖嘴钳	

绝缘钢丝钳

Insulated Linesman Pliers

- 通过VDE认证和10000V高压测试，耐压1000V
- 优质CR-V材质整体锻造
- 采用优质铬钒钢锻造，坚固耐用
- 双材料手柄，握持舒适
- 手柄特别保护设计，使用更安全
- VDE approved Insulated voltage range:0-1000V, by 10000V high voltage test
- Chrome-Vanadium steel
- Dual-material comfort grip handle
- Integral guards help prevent hand contact with conductive parts



Item no.	Size	Capacity(mm)	L(mm)	Icon
S046010	6"	钢丝 2.0	150	6
S046011	7"	钢丝 2.0	175	6
S046012	8"	钢丝 2.3	200	6



套装类、螺丝批、钳类、扳手、套筒、电工刀、锯架、线夹及镊子

绝缘尖嘴钳

Insulated Long Nose Pliers

- 通过VDE认证和10000V高压测试，耐压1000V
- 优质CR-V材质整体锻造
- 采用优质铬钒钢锻造，坚固耐用
- 双材料手柄，握持舒适
- 手柄特别保护设计，使用更安全
- VDE approved Insulated voltage range:0-1000V, by 10000V high voltage test
- Chrome-Vanadium steel
- Dual-material comfort grip handle
- Integral guards help prevent hand contact with conductive parts

CR-V **升级**
 △ 1000V
 IEC 60900
 DIN EN 60900



Item no.	Size	Capacity(mm)	L(mm)	
S046013	6"	钢丝 1.6	150	6
S046014	8"	钢丝 1.6	200	6

绝缘剥线钳

Insulated Wire Stripper

- 通过VDE认证和10000V高压测试，耐压1000V
- 优质CR-V材质整体锻造
- 采用优质铬钒钢锻造，坚固耐用
- 双材料手柄，握持舒适
- 手柄特别保护设计，使用更安全
- VDE approved Insulated voltage range:0-1000V, by 10000V high voltage test
- Chrome-Vanadium steel
- Dual-material comfort grip handle
- Integral guards help prevent hand contact with conductive parts

CR-V
 △ 1000V
 IEC 60900
 DIN EN 60900



Item no.	Size	L(mm)	
S046017	6"	150	6

VDE绝缘圆嘴钳

VDE Insulated Round -nose Pliers

- 通过VDE认证和10000V高压测试，耐压1000V
- 优质CR-V材质整体锻造
- 钳体采用优质CR-V锻造，坚固耐用
- 手柄特殊保护处理，使用安全
- VDE approved Insulated voltage range:0-1000V, by 10000V high voltage test
- Forged with CR-V steel
- Special protection treatment for handles to guarantee security

CR-V
 △ 1000V
 IEC 60900
 DIN EN 60900



Item no.	Size	
S150098	6"	6

绝缘斜嘴钳

Insulated Diagonal Pliers

- 通过VDE认证和10000V高压测试，耐压1000V
- 优质CR-V材质整体锻造
- 采用优质铬钒钢锻造，坚固耐用
- 双材料手柄，握持舒适
- 手柄特别保护设计，使用更安全
- VDE approved Insulated voltage range:0-1000V, by 10000V high voltage test
- Chrome-Vanadium steel
- Dual-material comfort grip handle
- Integral guards help prevent hand contact with conductive parts

CR-V **升级**
 △ 1000V
 IEC 60900
 DIN EN 60



Item no.	Size	Capacity(mm)	L(mm)	
S046015	6"	钢丝 2.0	150	6
S046016	7"	钢丝 2.0	180	6

VDE绝缘扁嘴钳

VDE Insulated Flat Nose Pliers

- 通过VDE认证和10000V高压测试，耐压1000V
- 优质CR-V材质整体锻造
- 钳体采用优质CR-V锻造，坚固耐用
- 手柄特殊保护处理，使用安全
- VDE approved Insulated voltage range:0-1000V, by 10000V high voltage test
- Forged with CR-V steel
- Special protection treatment for handles to guarantee security

CR-V
 △ 1000V
 IEC 60900
 DIN EN 60900



Item no.	Size	
S150097	6"	6

VDE绝缘弯嘴钳

VDE Insulated Bent Nose Pliers

- 通过VDE认证和10000V高压测试，耐压1000V
- 优质CR-V材质整体锻造
- 钳体采用优质CR-V锻造，坚固耐用
- 手柄特殊保护处理，使用安全
- VDE approved Insulated voltage range:0-1000V, by 10000V high voltage test
- Forged with CR-V steel, long life and durability
- Special protection treatment for handles to guarantee security

CR-V
 △ 1000V
 IEC 60900
 DIN EN 60900



Item no.	Size	
S150099	6"	6
S150100	8"	6

绝缘电缆钳

Injection Insulated Cable Shears

- 通过VDE认证和10000V高压测试，耐压1000V
- 优质CR-V材质整体锻造
- 刃口采用优质铬钒钢锻造，坚韧锋利，持久耐用
- 双色PP+TPR手柄，美观舒适
- VDE approved Insulated voltage range:0-1000V, by 10000V high voltage test
- Edge made from Chrome-Vanadium
- Bi-material soft grip handle for comfort



Item no.	L(mm)	mm ²	
S150001	150	22	3
S150002	250	80	3

绝缘棘轮式电缆剪

Insulated Injection Cable Cutters

- 通过VDE认证和10000V高压测试，耐压1000V
- 优质CR-V材质整体锻造
- 刃口采用优质钢材锻造，坚韧锋利，持久耐用
- 采用棘轮结构，自锁功能设计，省力，便捷
- 双色PP+TPR手柄，美观舒适
- VDE approved Insulated voltage range:0-1000V, by 10000V high voltage test
- Edge made from High-grade forged steel
- Built-in ratchet & self-locking function
- Bi-material soft grip handle for comfort



⚠ 可切割多股铜、铝芯电缆，不适合剪铁丝、钢芯、电缆等

For quick & easy copper & aluminum cables cutting, not suitable for wire & steel core cable cutting.



Item no.	Size	mm	mm ²	
S150003	10"	32	240	1
S150004	12.5"	52	380	1

双色柄绝缘电缆剪

Bi-color handle Insulated Cable Cutters

- 通过VDE认证和10000V高压测试，耐压1000V
- 优质CR-V材质整体锻造
- 刃口采用优质钢材锻造，坚韧锋利，持久耐用
- 双色PP+TPR手柄，美观舒适
- VDE approved Insulated voltage range:0-1000V, by 10000V high voltage test
- Edge made from High-grade forged steel
- Bi-material soft grip handle for comfort



Item no.	Size(mm)	L(mm)	
S150051	250	610	1
S150052	500	805	1

双色柄绝缘电缆剪

VDE Insulated Shears

- 通过VDE认证和10000V高压测试，耐压1000V
- 优质CR-V材质整体锻造
- 刃口采用优质钢材锻造，坚韧锋利，持久耐用
- 双色PP+TPR手柄，美观舒适
- VDE approved Insulated voltage range:0-1000V, by 10000V high voltage test
- Edge made from High-grade forged steel
- Bi-material soft grip handle for comfort



Item no.	L(mm)	
S150070	150mm	12

VDE绝缘断线钳

VDE Bolt Insulated Cutter

- 通过VDE认证和10000V高压测试，耐压1000V
- 优质CR-V材质整体锻造
- 钳头采用优质CR-V材质锻造，刃口硬度达到HRC58
- VDE approved Insulated voltage range:0-1000V, by 10000V high voltage test
- Forged with CR-V steel, blade hardness up to HRC58



Item no.	Size(mm)	
S150092	600	1

双色柄绝缘活动扳手

Insulated Injection Adjustable Wrench

- 通过VDE认证和10000V高压测试，耐压1000V
- 优质CR-V材质整体锻造
- 双色PP+TPR注塑工艺手柄
- VDE approved Insulated voltage range:0-1000V, by 10000V high voltage test
- High-grade forged CR-V steel
- Bi-material injection molded handle



Item no.	Size	
S154008	8"	3
S154010	10"	3
S154012	12"	3

双色柄绝缘开口扳手

Bi-color handle Insulated Open Jaw Wrench

- 通过VDE认证和10000V高压测试，耐压1000V
- 优质CR-V材质整体锻造
- 双色PP+TPR注塑工艺手柄
- VDE approved Insulated voltage range:0-1000V, by 10000V high voltage test
- High-grade forged CR-V steel
- Bi-material injection molded handle

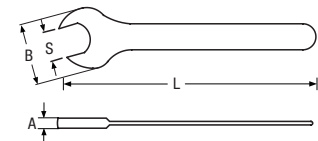

Item no.	S(mm)	A(mm)	B(mm)	L(mm)	
S152006	6	7	21.8	89.5	6
S152007	7	7.5	24	89.5	6
S152008	8	7.5	25.3	99.5	6
S152009	9	7.5	27.4	99.5	6
S152010	10	8	31	110	6
S152011	11	8.5	34	120	6
S152012	12	8.5	36	130	6
S152013	13	10.5	39	140	6
S152014	14	10.5	40	150	6
S152015	15	11.5	42	160	6
S152016	16	11.5	43	165	6
S152017	17	12.5	47	165	6
S152018	18	13	50	175	6
S152019	19	14	53	180	6
S152021	21	14	55	195	6
S152022	22	14	58	205	6
S152024	24	14	62	230	3
S152027	27	13.8	60	250	3
S152030	30	14.6	64	310	3
S152032	32	15.7	68	320	3



套装类、螺丝批、钳类、扳手、套筒、电刀、锯架、线夹及镊子

双色柄绝缘梅花扳手

Insulated Injection Ring Wrench

- 通过VDE认证和10000V高压测试，耐压1000V
- 优质CR-V材质整体锻造
- 双色PP+TPR注塑工艺手柄
- VDE approved Insulated voltage range:0-1000V, by 10000V high voltage test
- High-grade forged CR-V steel
- Bi-material injection molded handle

CR-V
 △ 1000V
 IEC 60900
 DIN EN 60900

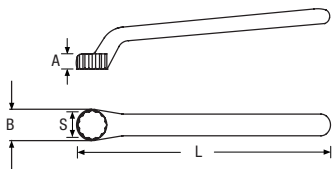

Item no.	S(mm)	A(mm)	B(mm)	L(mm)	
S153006	6	7	21.8	153	6
S153007	7	7	24	153	6
S153008	8	7.5	25.3	153	6
S153009	9	7.5	27.4	162	6
S153010	10	9	21	170	6
S153011	11	10	22.5	180	6
S153012	12	10	22.5	190	6
S153013	13	11	26.5	200	6
S153014	14	12	28	210	6
S153015	15	12	29	215	6
S153016	16	12	31	215	6
S153017	17	13	32	220	6
S153018	18	13	35	230	6
S153019	19	14	36	240	6
S153021	21	14	39	250	6
S153022	22	15	41	260	6
S153024	24	16	44	280	3
S153027	27	17	46	290	3
S153030	30	18	49	310	3
S153032	32	19	52	320	3

VDE绝缘棘轮扳手

VDE Ratchet Combination Wrench

- 通过VDE认证和10000V高压测试，耐压1000V
- 本体采用优质CR-V材质锻造
- 双向72齿棘轮结构，操作方便
- VDE approved Insulated voltage range:0-1000V, by 10000V high voltage test
- Forged with CR-V steel
- Reversible 72-tooth ratcheting structure, easy operation

CR-V
 △ 1000V
 IEC 60900
 DIN EN 60900



Item no.	Size(mm)	
S150085	10	3
S150086	11	3
S150087	12	3
S150088	13	3
S150089	14	3
S150090	15	3
S150091	16	3

双色柄绝缘T型套筒扳手

Bi-color handle Insulated T-handle Nut Screwdriver

- 通过VDE认证和10000V高压测试，耐压1000V
- 优质CR-V材质整体锻造
- 双色PP+TPR注塑工艺手柄
- VDE approved Insulated voltage range:0-1000V, by 10000V high voltage test
- High-grade forged CR-V steel
- Bi-material injection molded handle

1/2" 3/8" CR-V
 △ 1000V
 IEC 60900
 DIN EN 60900

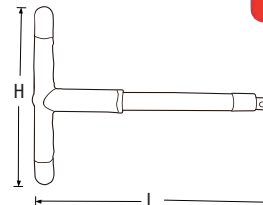

Item no.	Drive	H(mm)	L(mm)	
S155015	3/8"	165	200	6
S156018	1/2"	165	200	6

双色柄绝缘内六角

VDE Bi-color handle Insulated Hex Key

- 通过VDE认证和10000V高压测试，耐压1000V
- 优质CR-V材质整体锻造
- 双色PP+TPR注塑工艺手柄
- VDE approved Insulated voltage range:0-1000V, by 10000V high voltage test
- High-grade forged CR-V steel
- Bi-material injection molded handle

CR-V
 △ 1000V
 IEC 60900
 DIN EN 60900



Item no.	Size(mm)	
S150063	3	12
S150064	4	12
S150065	5	12
S150066	6	12
S150068	8	12
S150060	10	12
S150062	12	6

双色柄绝缘双向棘轮扳手

Insulated Reversible Ratchet

- 通过VDE认证和10000V高压测试，耐压1000V
- 优质CR-V材质整体锻造
- 快速脱落双向调节，36齿棘轮，使用便捷
- 双色PP+TPR注塑工艺手柄
- VDE approved Insulated voltage range:0-1000V, by 10000V high voltage test
- High-grade forged CR-V steel
- Dr. ratchet, reversible, 36-teeth gear
- Bi-material injection molded handle

1/2" 3/8" CR-V
 △ 1000V
 IEC 60900
 DIN EN 60900



Item no.	Drive	L(mm)	
S154045	1/4"	145	6
S155018	3/8"	200	6
S156016	1/2"	250	6

VDE绝缘尖尾棘轮扳手

VDE Construction Ratchet Wrench

- 通过VDE认证和10000V高压测试，耐压1000V
- 本体采用优质CR-V材质锻造
- 双向36齿棘轮结构，操作方便
- VDE approved Insulated voltage range:0-1000V, by 10000V high voltage test
- Forged with CR-V steel
- Reversible 36-teeth ratcheting structure, easy operation

CR-V
 △ 1000V
 IEC 60900
 DIN EN 60900



Item no.	Size(mm)	
S150082	13x17	3
S150083	17x19	3
S150084	19x24	3

1/2"绝缘六角旋具套筒

Injection Insulated Hexagon Socket

- 通过VDE认证和10000V高压测试，耐压1000V
- 优质CR-V材质整体锻造
- 旋具头采用S2高级合金钢，更耐用
- 注塑工艺加工
- VDE approved Insulated voltage range:0-1000V, by 10000V high voltage test
- High-grade forged CR-V steel
- S2 body for durability & longer life
- Injection molding process

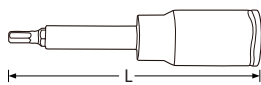

Item no.	Size(mm)	L(mm)	
S158001	4	120	6
S158002	5	120	6
S158003	6	120	6
S158004	8	120	6
S158005	10	120	6

3/8"绝缘六角旋具套筒

3/8" Insulated Hexagon Socket

- 通过VDE认证和10000V高压测试，耐压1000V
- 优质CR-V材质整体锻造
- 旋具头采用S2高级合金钢，更耐用
- 注塑工艺加工
- VDE approved Insulated voltage range:0-1000V, by 10000V high voltage test
- S2 body for durability & longer life
- High-grade forged CR-V steel
- Injection molding process

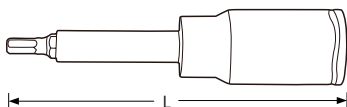

Item no.	Size(mm)	L(mm)	
S157001	4	75	6
S157002	5	75	6
S157003	6	75	6
S157004	8	75	6

绝缘套筒加长接杆

Injection Insulated Extension Bar

- 通过VDE认证和10000V高压测试，耐压1000V
- 优质CR-V材质整体锻造
- 注塑工艺加工
- VDE approved Insulated voltage range:0-1000V, by 10000V high voltage test
- High-grade forged CR-V steel
- Injection molding process

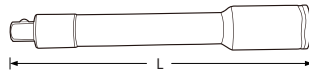

Item no.	Drive	L(mm)	
S155016	3/8"	125	6
S155017	3/8"	250	6
S156019	1/2"	125	6
S156020	1/2"	250	6

绝缘T型套筒扳手

Dipped Insulated T-Socket Wrench

- 通过VDE认证和10000V高压测试，耐压1000V
- 优质CR-V材质整体锻造
- VDE approved Insulated voltage range:0-1000V, by 10000V high voltage test
- High-grade forged CR-V steel
- Insulated voltage range:0-1000V

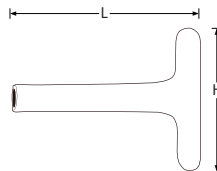

Item no.	Size(mm)	L(mm)	H(mm)	
S150026	8	200	90	6
S150027	10	200	155	6
S150028	12	200	155	6
S150029	13	200	155	6
S150030	14	200	155	6
S150031	16	200	155	6
S150032	17	200	155	6
S150033	18	200	155	6
S150034	19	200	155	6
S150035	8	300	90	6
S150036	10	300	155	6
S150037	12	300	155	6
S150038	13	300	155	6
S150039	14	300	155	6
S150040	16	300	155	6
S150041	17	300	155	6
S150042	18	300	155	6
S150043	19	300	155	6

绝缘T型内六角扳手

Dipped Insulated T-socket Wrench

- 通过VDE认证和10000V高压测试，耐压1000V
- 优质CR-V材质整体锻造
- 旋具头采用S2高级合金钢，更耐用
- VDE approved Insulated voltage range:0-1000V, by 10000V high voltage test
- S2 body for durability & longer life
- High-grade forged CR-V steel

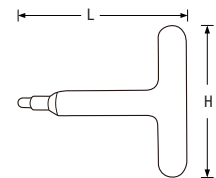

Item no.	Size(mm)	L(mm)	H(mm)	
S150019	5	120	90	6
S150020	6	120	90	6
S150021	8	120	90	6
S150022	10	120	90	6
S150023	5	250	90	6
S150024	6	250	90	6
S150025	8	250	90	6

1/4"绝缘公制六角套筒

1/4" VDE Hexagon Socket

- 通过VDE认证和10000V高压测试，耐压1000V
- 优质CR-V材质整体锻造
- 注塑工艺加工
- VDE approved Insulated voltage range:0-1000V, by 10000V high voltage test
- High-grade forged CR-V steel
- Injection molding process

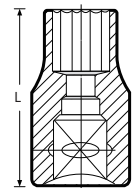

Item no.	Size(mm)	L(mm)	
S154024	4	42	6
S154026	5	42	6
S154027	5.5	42	6
S154028	6	42	6
S154029	7	42	6
S154030	8	42	6
S154031	9	42	6
S154032	10	42	6
S154033	11	42	6
S154034	12	42	6
S154035	13	42	6
S154036	14	42	6



3/8"绝缘公制六角套筒

3/8" VDE Hexagon Socket

- 通过VDE认证和10000V高压测试，耐压1000V
- 优质CR-V材质整体锻造
- 注塑工艺加工
- VDE approved Insulated voltage range:0-1000V by 10000V high voltage test
- High-grade forged CR-V steel
- Injection molding process

3/8" CR-V

1000V
IEC 60900
DIN EN 6090

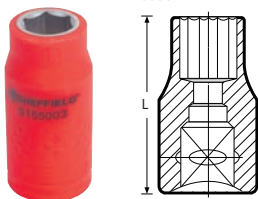

Item no.	Size(mm)	L(mm)	
S155001	8	44	6
S155002	10	44	6
S155003	11	44	6
S155004	12	44	6
S155005	13	44	6
S155006	14	44	6
S155007	16	44	6
S155008	17	44	6
S155009	18	44	6
S155010	19	46	6
S155011	21	46	6
S155012	22	46	6

双色柄绝缘直平型电缆刀

Insulated Cable Knife (Straight)

- 通过VDE认证和10000V高压测试，耐压1000V
- 采用优质不锈钢材质，经特殊热处理加工
- 刃口特殊处理，硬度大于HRC54
- 双色PP+TPR手柄，美观舒适
- VDE approved Insulated voltage range:0-1000V by 10000V high voltage test
- High-grade stainless steel, heat treated
- Bi-material soft grip handle for comfort

1000V
IEC 60900
DIN EN 60900

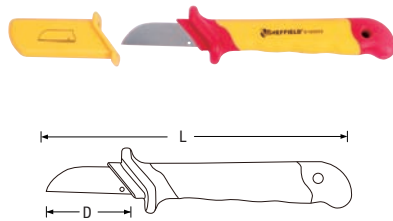

Item no.	D(mm)	L(mm)	
S150005	50	150	6

双色柄绝缘镰刀型电缆刀

Insulated Cable Knife (Long hook)

- 通过VDE认证和10000V高压测试，耐压1000V
- 采用优质不锈钢材质，经特殊热处理加工
- 刃口特殊处理，硬度大于HRC54度
- 双色PP+TPR手柄，美观舒适
- VDE approved Insulated voltage range:0-1000V by 10000V high voltage test
- High-grade stainless steel, heat treated
- Specid treatment for blade, blade hardness up to HRC54
- Bi-color soft grip handle for comfort

1000V
IEC 60900
DIN EN 60900

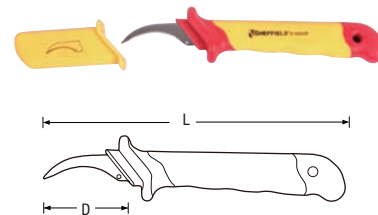

Item no.	D(mm)	L(mm)	
S150007	50	180	6

1/2"绝缘公制六角套筒

1/2" VDE Hexagon Socket

- 通过VDE认证和10000V高压测试，耐压1000V
- 优质CR-V材质整体锻造
- 注塑工艺加工
- VDE approved Insulated voltage range:0-1000V by 10000V high voltage test
- High-grade forged CR-V steel
- Injection molding process

1/2" CR-V

1000V
IEC 60900
DIN EN 60900

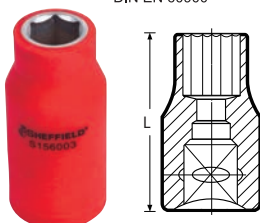

Item no.	Size(mm)	L(mm)	
S156001	10	54	6
S156002	11	54	6
S156003	12	54	6
S156004	13	54	6
S156005	14	54	6
S156006	16	54	6
S156007	17	54	6
S156008	18	54	6
S156009	19	54	6
S156010	21	54	6
S156011	22	54	6
S156012	24	54	3
S156013	27	58	3
S156014	30	59	3
S156015	32	59	3

双色柄绝缘小圆型电缆刀

Insulated Dismantling Knife (Semicircle)

- 通过VDE认证和10000V高压测试，耐压1000V
- 采用优质不锈钢材质，经特殊热处理加工
- 刃口特殊处理，硬度大于HRC54度
- 双色PP+TPR手柄，美观舒适
- VDE approved Insulated voltage range:0-1000V by 10000V high voltage test
- High-grade stainless steel, heat treated
- Specid treatment for blade, blade hardness up to HRC54
- Bi-color soft grip handle for comfort

1000V
IEC 60900
DIN EN 60900

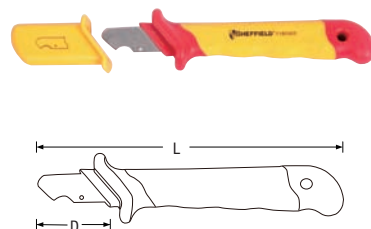

Item no.	D(mm)	L(mm)	
S150006	28	155	6

VDE绝缘电工胶带

VDE Insulated Technician Tape

- 通过VDE认证和10000V高压测试，耐压1000V
- VDE approved Insulated voltage range:0-1000V by 10000V high voltage test

1000V
IEC 60900
DIN EN 60900



Item no.	Size	
S150075	9mx19mm	50

双色柄绝缘护套直平型电缆刀

Bi-color handle Insulated Cable Knife (Guard)

- 通过VDE认证和10000V高压测试，耐压1000V
- 采用优质不锈钢材质，经特殊热处理加工
- 刃口特殊处理，硬度大于HRC54度
- 双色PP+TPR手柄，美观舒适
- VDE approved Insulated voltage range:0-1000V by 10000V high voltage test
- High-grade stainless steel, heat treated
- Specid treatment for blade, blade hardness up to HRC54
- Bi-color soft grip handle for comfort

 ▲ 1000V
 IEC 60900
 DIN EN 60900

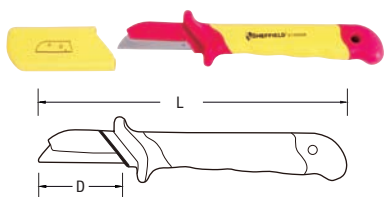

Item no.	D(mm)	L(mm)	
S150008	50	180	6

双色柄绝缘护套钩镰型电缆刀片

Insulated Dismantling Knife (brushhook)

- 通过VDE认证和10000V高压测试，耐压1000V
- 采用优质不锈钢材质，经特殊热处理加工
- 刃口特殊处理，硬度大于HRC54度
- VDE approved Insulated voltage range:0-1000V by 10000V high voltage test
- High-grade stainless steel, heat treated
- Specid treatment for blade, blade hardness up to HRC54

 ▲ 1000V
 IEC 60900
 DIN EN 60900



Item no.	
S150050	6

双色柄绝缘护套钩镰型电缆刀

Insulated Dismantling Knife (brushhook)

- 通过VDE认证和10000V高压测试，耐压1000V
- 采用优质不锈钢材质，经特殊热处理加工
- 刃口特殊处理，硬度大于HRC54度
- 双色PP+TPR手柄，美观舒适
- VDE approved Insulated voltage range:0-1000V by 10000V high voltage test
- High-grade stainless steel, heat treated
- Specid treatment for blade, blade hardness up to HRC54
- Bi-material soft grip handle for comfort

 ▲ 1000V
 IEC 60900
 DIN EN 60900

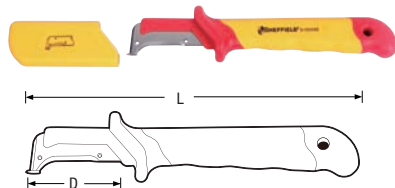

Item no.	D(mm)	L(mm)	
S150009	38	155	6

双色柄绝缘直平可换式电缆刀

Injection Insulated Cable Knife (Changable)

- 通过VDE认证和10000V高压测试，耐压1000V
- 采用优质不锈钢材质，经特殊热处理加工
- 刃口特殊处理，硬度大于HRC54度
- 双色PP+TPR手柄，美观舒适
- VDE approved Insulated voltage range:0-1000V by 10000V high voltage test
- Specid treatment for blade, blade hardness up to HRC54
- High-grade stainless steel, heat treated
- Bi-material soft grip handle for comfort

 ▲ 1000V
 IEC 60900
 DIN EN 60900



Item no.	D(mm)	L(mm)	
S150010	58	185	6

双色柄绝缘锯架

Insulated Junior Hacksaw

- 通过VDE认证和10000V高压测试，耐压1000V
- 金属材料锯架，重型设计款式，坚固耐用
- 锯条采用优质HSS材质，更加锋利
- 双色PP+TPR手柄，美观舒适
- VDE approved Insulated voltage range:0-1000V by 10000V high voltage test
- Heavy duty metal frame for durability & longer life
- Blade made of high quality HSS more material shaper
- Bi-material soft grip handle for comfort

 ▲ 1000V
 IEC 60900
 DIN EN 60900

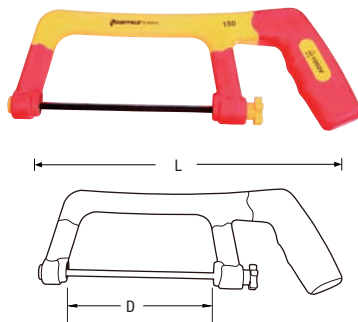

Item no.	D(mm)	L(mm)	
S150016	150	280	6

绝缘塑料圆头线夹

Insulated Plastic Clamp

- 通过VDE认证和10000V高压测试，耐压1000V
- 高硬度弹簧，确保使用夹持力
- 特殊增加护套设计，使用更加安全
- VDE approved Insulated voltage range:0-1000V by 10000V high voltage test
- reinforced spring ensure maximum clamping capacity
- Soft padded jaws to protect work piece

 ▲ 1000V
 IEC 60900
 DIN EN 60900



Item no.	L(mm)	
S150017	150	12

绝缘塑料尖头线夹

Insulated Plastic Flat Nose Plier

- 通过VDE认证和10000V高压测试，耐压1000V
- 高硬度弹簧，确保使用夹持力
- 特殊增加护套设计，使用更加安全
- VDE approved Insulated voltage range:0-1000V by 10000V high voltage test
- reinforced spring ensure maximum clamping capacity
- Soft padded jaws to protect work piece

 ▲ 1000V
 IEC 60900
 DIN EN 60900



Item no.	L(mm)	
S150018	200	12

绝缘塑料滑套

Insulated Plastic Slip-on Caps

- 通过VDE认证和10000V高压测试，耐压1000V
- 优质绝缘橡胶材料制造
- VDE approved Insulated voltage range:0-1000V by 10000V high voltage test
- Insulated rubberized plastic body

 ▲ 1000V
 IEC 60900
 DIN EN 60900



Item no.	L(mm)	
S150044	80	12
S150045	80	12
S150046	80	12



套装类、螺丝批、钳类、扳手、套筒、电刀、锯架、线夹及镊子

绝缘塑料自动夹紧滑套

Insulated Self-clamping Slip On Caps

- 通过VDE认证和10000V高压测试，耐压1000V
- 优质绝缘橡胶材料制造
- VDE approved Insulated voltage range:0-1000V by 10000V high voltage test
- Insulated rubberized plastic body



1000V
IEC 60900
DIN EN 60900



Item no.	L(mm)	
S150047	10	12
S150048	20	12
S150049	30	12

双色柄绝缘微尖横齿镊子

Injection Insulated Precision Tweezers

- 通过VDE认证和10000V高压测试，耐压1000V
- 采用优质不锈钢材质制造，防磁
- VDE approved Insulated voltage range:0-1000V by 10000V high voltage test
- Hi-quality stainless steel, anti-magnetic



1000V
IEC 60900
DIN EN 60900



Item no.	L(mm)	
S150013	150	6

VDE绝缘扭力扳手

VDE Torque Wrench

- 通过VDE认证和10000V高压测试，耐压1000V
- 本体精密钢材锻造，精抛磨光加工处理，保证配件精度，精度±3%
- 视窗刻度盘，双刻度显示，操作简单，示值精确
- VDE approved Insulated voltage range:0-1000V by 10000V high voltage test
- with precision steel, mirror-polished to guarantee precision, Accuracy: ±3%
- Window dial, twin dials display, easy operation, accurate display



1000V
IEC 60900
DIN EN 60900



Item no.	Drive	N.m	
S150093	1/4"	5-25N.m	1
S150094	3/8"	5-25N.m	1
S150095	3/8"	10-50N.m	1
S150096	1/2"	10-50N.m	1

高压测电笔

Voltage Insulated Tester

- 刀杆采用优质CR-V材质，经久耐用
- 最大测量范围：1000V
- CR-V blade for durability & long life
- Measuring range: 0-1000V



1000V
IEC 60900
DIN EN 60900



Item no.	L(mm)	
S150011	70	6

双色柄绝缘弯尖横齿镊子

Injection Insulated Precision Tweezers

- 通过VDE认证和10000V高压测试，耐压1000V
- 采用优质不锈钢材质制造，防磁
- VDE approved Insulated voltage range:0-1000V by 10000V high voltage test
- Hi-quality stainless steel, anti-magnetic



45°



1000V
IEC 60900
DIN EN 60900



Item no.	L(mm)	
S150014	150	6

VDE绝缘十字轮胎扳手

VDE Lug Wrench

- 通过VDE认证和10000V高压测试，耐压1000V
- 本体采用优质CR-V材质锻造
- VDE approved Insulated voltage range:0-1000V by 10000V high voltage test
- Forged with CR-V steel



1000V
IEC 60900
DIN EN 60900



Item no.	Size(mm)	
S150080	13,14,17,19	3

双色柄绝缘针尖无齿镊子

Insulated Precision Tweezers (No gear)

- 通过VDE认证和10000V高压测试，耐压1000V
- 采用优质不锈钢材质制造，防磁
- VDE approved Insulated voltage range:0-1000V by 10000V high voltage test
- Hi-quality stainless steel, anti-magnetic



1000V
IEC 60900
DIN EN 60900



Item no.	L(mm)	
S150012	130	6

双色柄绝缘宽头横齿镊子

Insulated Precision Tweezers

- 通过VDE认证和10000V高压测试，耐压1000V
- 采用优质不锈钢材质制造，防磁
- VDE approved Insulated voltage range:0-1000V by 10000V high voltage test
- Hi-quality stainless steel, anti-magnetic



1000V
IEC 60900
DIN EN 60900



Item no.	L(mm)	
S150015	142	6

VDE绝缘可换头安装锤

VDE Insulated Finishing Hammer

- 通过VDE认证和10000V高压测试，耐压1000V
- 锤头采用聚氨酯材料制造，软性半透明
- 有效防震，敲击无火花
- VDE approved Insulated voltage range:0-1000V by 10000V high voltage test
- Soft half-transparent
- Non-rebounding, non-spark



1000V
IEC 60900
DIN EN 60900



Item no.	Size(mm)	
S150081	30	3



液压类工具 **HYDRAULIC TOOLS**

液压压线钳、液压断线钳、液压拉马
Hydraulic Crimping Tool, Hydraulic Cutting Tool, Hydraulic Puller

液压压线钳

Hydraulic Crimping Tool

- 头部采用合金钢锻造加工，表面镀铬处理
- FRP手柄，橡胶胶套，绝缘耐压，握持舒适
- 快速液压控制系统，压接泄压回位迅速，操作方便省力
- 配备9副压接口模:50,70,95,120,150,185,240,300,400mm²
- 压接头部可以180度旋转，内置安全液压阀，有效防止超负荷使用，最大压力达到13吨
- Forged alloy steel for head,chrome plated
- FRP handle with rubber,insulated suitable for handing
- Quick Hydraulic control system,automatic pressure relief,easy maintenance and operation
- 9 pairs of standard interchangeable dies: 50,70,95,120,150,185,240,300,400mm²
- 180°swivel head work for a variety of angles, build-in safety valve to prevent overloading. Max crimping force:130Ton

压接头部采用合金钢锻造加工
表面镀铬处理，坚固耐用
Forged alloy steel for head,chrome plated



配备9副压接口模
方便使用
9 pairs of standard interchangeable dies

压接头部可以180度旋转
180°swivel head work for a variety of angles



快速液压控制系统，压接泄压回位迅速，操作方便省力，内置安全液压阀，有效防止超负荷使用，最大压力达到13吨

Quick Hydraulic control system,automatic pressure relief,easy maintenance and operation,build-in safety valve to prevent overloading.Max crimping force:130 Ton

Item no.	Capacity(mm ²)	
S160001	50, 70, 95, 120, 150, 185, 240, 300, 400	1

液压压线钳

Hydraulic Crimping Tool

- 头部采用合金钢锻造加工，表面镀铬处理
- 快速液压控制系统，压接泄压回位迅速，操作方便省力
- 配备10副压接口模:16,25,35,50,70,95,120,150,185,240mm²
- 压接头部可以180度旋转，内置安全液压阀，有效防止超负荷使用，最大压力达到10吨
- Forged alloy steel for head,chrome plated
- Quick Hydraulic control system,automatic pressure relief,easy maintenance and operation
- 10 pairs of standard interchangeable dies:16,25,35,50,70,95,120,150,185,240mm²
- 180°swivel head work for a variety of angles,build-in safety valve to prevent overloading.Max crimping force:100KN

⚠ 使用前请务必认真阅读说明书，按说明书要求操作
Please be sure to read the instructions carefully before use, operate according to the specification.



Item no.	Capacity(mm ²)	
S160002	16,25, 35, 50, 70, 95, 120, 150, 185, 240	1

液压断线钳

Hydraulic Cutting Tool

- 头部采用合金钢锻造加工，表面磷化发黑处理
- 剪切刃口采用优质合金钢锻造，高频热处理，锋利耐用
- 头部可以90°旋转，便于不同工位使用操作
- 360°可旋转油泵头，快速液压控制系统，压接泄压回位迅速，操作方便省力
- 内置安全液压阀，有效防止超负荷使用，最大压力达到5T
- 使用范围：硬铜绞线φ28mm，铝绞线φ38mm，电力电缆线φ85mm
- Forged alloy steel for head, black finishing for surface
- Forged alloy steel for cutting edge,heat treatment,sharp and durable
- 90°swivel head for different angles required.
- Quick Hydraulic control system,automatic pressure relief,easy maintenance and operation
- build-in safety valve to prevent overloading.Max crimping force:5T
- φ28mm following copper wire,φ38 following all copper aluminium conductor,φ85mm following winding wire

⚠ 使用前请务必认真阅读说明书，按说明书要求操作
Please be sure to read the instructions carefully before use, operate according to the specification.



Item no.	Capacity	
S160004	85mm	1

液压断线钳

Hydraulic Cutting Tool

- 头部采用合金钢锻造加工，表面磷化发黑处理
- 剪切刃口采用优质合金钢锻造，高频热处理，锋利耐用
- 头部可以90°旋转，便于不同工位使用操作
- 快速液压控制系统，压接泄压回位迅速，操作方便省力
- 内置安全液压阀，有效防止超负荷使用，最大压力达到6T
- 使用范围：钢筋φ16mm，钢芯铝线φ30mm（800mm平方），钢丝绳φ25mm，XLPE电力电缆φ30mm，通信电缆φ30mm
- Forged alloy steel for head black finishing for surface
- Forged alloy steel for cutting edge,heat treatment,sharp and durable.
- 90°swivel head for different angles required.
- Quick Hydraulic control system,automatic pressure relief,easy maintenance and operation
- Build-in safety valve to prevent overloading.Max crimping force:6T
- Crimping range: 16mm following copper wire, 30mm(800mm²) following steel-reinforced aluminium conductors 25mm following Cable line, 30mm(600mm²) following all copper aluminium conductor 30mm following winding wire

⚠ 使用前请务必认真阅读说明书，按说明书要求操作
Please be sure to read the instructions carefully before use, operate according to the specification.

升级



Item no.	Capacity	
S160003	30mm	1

液压拉马

Hydraulic Puller

- 拉爪采用合金钢整体锻造，2爪、3爪通用底座，操作灵活，更换快速
- 手柄采用优质冷轧钢管，表面镀铬处理，防锈耐腐蚀
- 360°可旋转油泵头，快速液控控制系统，回位迅速，操作方便省力
- 内置安全液压阀，有效防止超负荷使用
- 内部独特配备安全防护网
- made from high strength forged alloy steel,Three-pawl ,two-pawl simultaneously control.Flexible operation convenience use
- Pulling jaws made from super-strength cold-rolled steel tubes ,chromate plated,anti-corrosion
- 360°swivel pump work for a variety of angles,Quick Hydraulic control system,automatic pressure relief,easy maintenance and operation
- Build-in safety valve to prevent overloading.
- Unique configuration safety protective device

⚠ 使用前请务必认真阅读说明书，按说明书要求操作
Please be sure to read the instructions carefully before use, operate according to the specification.



Item no.	Size	Stroke(mm)	Spread(mm)	
S160005	6T	70	330	1
S160006	8T	85	350	1
S160007	12T	85	375	1
S160008	20T	111	520	1
S160009	30T	111	550	1



夹持类工具 **HOLDING TOOLS**

台虎钳、F夹、普通钳、挡圈钳、大力钳
Vise, F-Clamp, Pliers, Locking Pliers

平口钳

4" Drill Press Vise

- 钳体采用铸铁制造
- 钳头经热处理
- 摇柄表面镀铬处理
- 适合铣床作业
- 最大开口100mm
- Durable cast iron construction
- Hardened steel jaws
- Chrome plated, cold rolled steel screws
- For securing work on flat table drill presses
- Jaw opening: 4"(100mm)

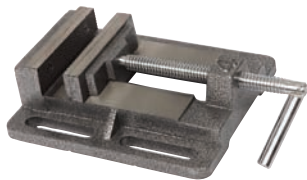

Item no.	Size	Maximum opening(mm)	
S040000	4"	100	1

重型T柄F夹

Heavy Duty T-Handle F-Clamps

- 优质钢材整体锻造
- 特殊热处理加工，确保夹持硬度
- Forged steel, Heat-treated, hardened
- Specied heat treatment, ensure the clamping hardness.

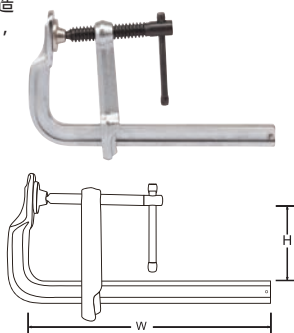

Item no.	Size(mm)	H(mm)	W(mm)	ClampPressure(kg)	
S049101	80X160	160	80	250	4
S049102	120X200	120	200	370	4
S049104	120X300	120	300	370	4
S049105	120X400	120	400	370	4
S049106	120X500	120	500	370	4
S049107	120X600	120	600	370	4

重型管子台虎钳

Yoke Vise

- 钳体采用铸铁制造
- 齿块锻压经热处理，夹持稳固耐用
- Durable cast iron construction yoke and base
- Hardened steel jaws for sure grip and durability



Item no.	Size	Maximum opening(mm)	
S040002	2"	50	1
S040003	3"	75	1

重型快速F夹

Heavy Duty T-Handle F-Clamps

- 优质钢材整体锻造，特殊热处理加工，确保夹持硬度
- 独特快速锁紧结构，使用方便，省力
- Forged steel, heat-treated
- Quick-release design for easy operation

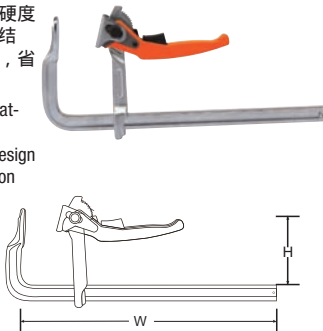

Item no.	Size(mm)	H(mm)	W(mm)	ClampPressure(kg)	
S049201	100X200	100	200	250	6
S049202	120X250	120	250	275	4
S049203	120X300	120	300	335	4
S049204	120X400	120	400	335	4
S049205	120X500	120	500	335	4
S049206	120X600	120	600	335	4

重型台虎钳

Heavy Duty Bench Vise

- 采用铸铁制造
- Durable cast iron construction



Item no.	Size	N.W.(kg)	Maximum Opening(mm)	Clamping Force(kg)	Angle of Rotation(°)	
S040004	4"	9.5	100	1200	270°	1
S040005	5"	13.5	125	1600	270°	1
S040006	6"	20	150	2200	270°	1
S040007	7"	24	175	2600	270°	1
S040008	8"	29.5	200	3000	360°	1

G型夹钳

G-Clamp

- 采用优质玛钢锻造，加强筋设计，夹持力更高使用更安全
- 螺杆表面发黑
- 活动夹持头，有效夹持工件
- 适合木工、金属加工作业
- Drop forged malleable steel frame
- Black finish screw
- Swivel pad
- Ideal for most woodworking and metalworking applications

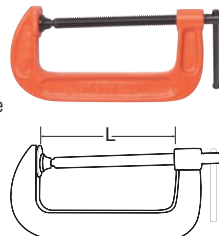

Item no.	Size	L(mm)	ClampPressure(kg)	
S049001	1"	25	200	12
S049002	2"	50	550	12
S049003	3"	75	950	6
S049004	4"	100	950	6
S049006	6"	150	1200	6
S049008	8"	200	1400	6

迷你不锈钢多用钳

Mini Multi-Purpose Pliers

- 采用优质不锈钢制造
- 可以折叠，携带方便
- Stainless steel
- Foldable, Easy to carry

送牛漆袋



Item no.	
S041001	6

尖嘴钳，标准钳，钢丝剪，剥皮孔，指甲钳，开罐器，中号一字螺丝刀，开瓶器，大号一字螺丝刀，锯齿刀，刀片，十字螺丝刀，小号一字螺丝刀
Long nose pliers, Regular pliers, Wire cutter, Wire stripper, Nail File, Can opener, Medium slotted screwdriver, Bottle opener, Large slotted screwdriver, Serrated knife, Blade, Phillips screwdriver, Small slotted screwdriver

18合1不锈钢多用钳

18-in-1 Multi-Purpose Tool

- 采用优质不锈钢制造
- 可以折叠，携带方便
- Stainless steel
- Foldable, Easy to carry

送牛漆袋



Item no.	
S041002	6

尖嘴钳，标准钳，钢丝剪，剥皮孔，3合1锉刀，锯，开罐器，十字螺丝刀，去钩器，开瓶器，锯齿刀，电缆刀，大号一字螺丝刀，中号一字螺丝刀，小号一字螺丝刀
Long nose pliers, Regular pliers, Wire cutter, Wire stripper, Meat/Wood File, Saw, Can opener, Phillips screwdriver, Bottle opener, Hook remover, Serrated knife, Large blade, Large slotted screwdriver, Medium slotted screwdriver, Small slotted screwdriver

12合1不锈钢多用钳

12-in-1 Multi-Purpose Tool

- 采用优质不锈钢制造
- 可以折叠，携带方便
- Stainless steel
- Foldable, Easy to carry

送牛漆袋



Item no.	
S041003	6

尖嘴钳，标准钳，钢丝剪，剥皮孔，开罐器，十字螺丝刀，剪刀，一字螺丝刀，刀，LED灯，钥匙扣
Long nose pliers, Regular pliers, Wire cutter, Wire stripper, Can opener, Phillips screwdriver, Scissors, Medium slotted screwdriver, Large blade, LED light, Key ring

高档美式钢丝钳

Linesman Pliers

- 钳体经锻造热处理, 坚固耐用
- 刃口经特殊处理, 剪切能力强
- TPR+PP双材料手柄
- 符合美国ANSI标准
- Drop forged steel for longer life and durability
- Heat treated blade, strong shear capacity
- TPR+PP double dipped grip handle
- Meets or exceeds ANSI standard

升级

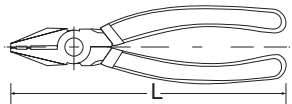

Item no.	Size	Capacity(mm)	L(mm)	
S044001	6"	钢丝 2.0	150	6
S044002	7"	钢丝 2.0	175	6
S044003	8"	钢丝 2.3	200	6

高档美式尖嘴钳

Long Nose Pliers

- 钳体经锻造热处理, 坚固耐用
- 刃口经特殊处理, 剪切能力强
- TPR+PP双材料手柄
- 符合美国ANSI标准
- Drop forged steel for longer life and durability
- Heat treated blade, strong shear capacity
- TPR+PP double dipped grip handle
- Meets or exceeds ANSI standard

升级

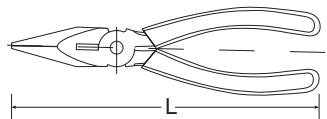

Item no.	Size	Capacity(mm)	L(mm)	
S044005	6"	钢丝 1.6	150	6
S044006	8"	钢丝 1.6	200	6

高档美式斜嘴钳

Diagonal Pliers

- 钳体经锻造热处理, 坚固耐用
- 刃口经特殊处理, 剪切能力强
- TPR+PP双材料手柄
- 符合美国ANSI标准
- Drop forged steel for longer life and durability
- Heat treated blade, strong shear capacity
- TPR+PP double dipped grip handle
- Meets or exceeds ANSI standard

升级

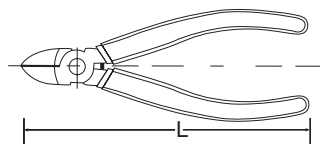

Item no.	Size	Capacity(mm)	L(mm)	
S044008	6"	钢丝 2.0	150	6
S044009	7"	钢丝 2.0	175	6

鲤鱼钳

Slip Joint Pliers

- 钳体经锻造热处理, 坚固耐用
- 刃口经特殊处理, 剪切能力强
- 双沾塑手柄, 握持舒适
- 符合美国ANSI标准
- Drop forged steel for longer life and durability
- Heat treated blade, strong shear capacity
- Double dipped grip handle
- Meets or exceeds ANSI standard

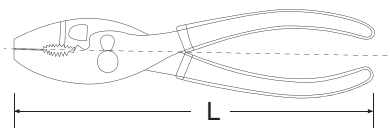

Item no.	Size	L(mm)	
S044010	6"	150	6
S044011	8"	200	6

水泵钳

Water Pump Pliers

- 钳体经锻造热处理, 坚固耐用
- 双沾塑手柄, 握持舒适
- 符合美国ANSI标准
- Drop forged steel for longer life and durability
- Double dipped grip handle
- Meets or exceeds ANSI standard

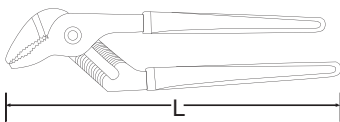

Item no.	Size	L(mm)	
S044014	8"	200	6
S044012	10"	250	6
S044013	12"	300	6

7寸顶切钳

7" end-cutting pliers

- 钳体经锻造热处理, 坚固耐用
- 刃口特殊处理, 剪切能力强
- 双沾塑手柄, 握持舒适
- Drop forged steel for longer life and durability
- Heat treated blade, strong shear capacity
- Double dipped grip handle

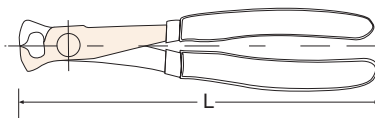

Item no.	Size	L(mm)	
S044015	7"	175	6

双色柄钢丝钳

Linesman Pliers

- 钳体采用CR-NI锻造, 坚固耐用
- 刃口经特殊处理, 剪切能力强
- TPR+PP双材料套柄, 握持舒适
- 符合美DIN标准
- Drop forged CR-NI steel for longer life and durability
- Heat treated blade, strong shear capacity
- Bi-material comfort grip handle
- Meets or exceeds DIN standard

CR-NI 升级

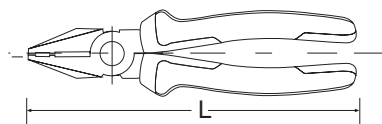

Item no.	Size	Capacity(mm)	L(mm)	
S045001	6"	钢丝 2.0	150	6
S045002	7"	钢丝 2.0	175	6
S045003	8"	钢丝 2.3	200	6

双色柄尖嘴钳

Long Nose Pliers

- 钳体采用CR-NI锻造，坚固耐用
- 刃口经特殊处理，剪切能力强
- TPR+PP双材料套柄，握持舒适
- 符合DIN 标准
- Drop forged CR-NI steel for longer life and durability
- Heat treated blade, strong shear capacity
- Bi-material comfort grip handle
- Meets or exceeds DIN standard

CR-NI 升级

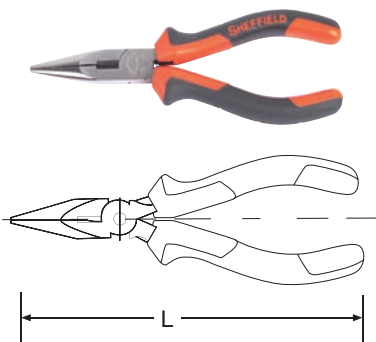

Item no.	Size	Capacity(mm)	L(mm)	
S045004	6"	钢丝 1.6	150	6
S045005	8"	钢丝 1.6	200	6

双色柄扁嘴钳

Flat Nose Pliers

- 钳体采用铬钒钢锻造，坚固耐用
- TPR+PP双材料套柄，握持舒适
- 符合DIN标准
- Drop forged CR-V steel for longer life and durability
- Bi-material comfort grip handle
- Meets or exceeds DIN standard

CR-V

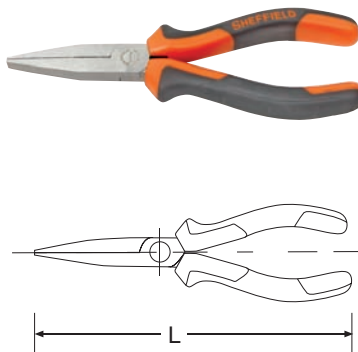

Item no.	Size	L(mm)	
S045008	6"	150	6

双色柄弯嘴钳

Bent Nose Pliers

- 钳体采用铬钒钢锻造，坚固耐用
- 刃口经特殊处理，剪切能力强
- TPR+PP双材料套柄，握持舒适
- 符合DIN 标准
- Drop forged CR-V steel for longer life and durability
- Heat treated blade, strong shear capacity
- Bi-material comfort grip handle
- Meets or exceeds DIN standard

CR-V

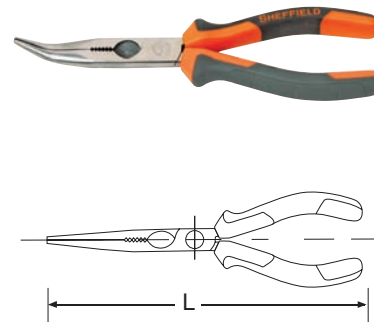

Item no.	Size	Capacity(mm)	L(mm)	
S045011	6"	钢丝 1.6	150	6
S045012	8"	钢丝 1.6	200	6

双色柄斜嘴钳

Diagonal Pliers

- 钳体采用CR-NI 锻造，坚固耐用
- 刃口经特殊处理，剪切能力强
- TPR+PP双材料套柄，握持舒适
- 符合DIN 标准
- Drop forged CR-NI steel for longer life and durability
- Heat treated blade, strong shear capacity
- Bi-material comfort grip handle
- Meets or exceeds DIN standard

CR-NI 升级

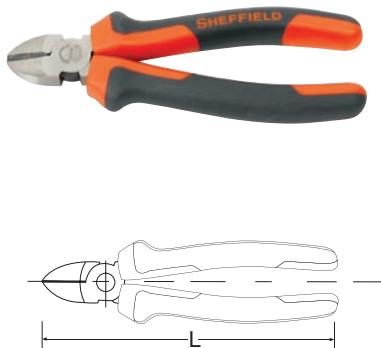

Item no.	Size	Capacity(mm)	L(mm)	
S045006	6"	钢丝 2.0	150	6
S045007	7"	钢丝 2.0	175	6

双色柄水泵钳

Groove Joint Pliers

- 钳体采用铬钒钢锻造，坚固耐用
- TPR+PP双材料套柄，握持舒适
- 符合美国ANSI标准
- Drop forged CR-V steel for longer life and durability
- Bi-material comfort grip handle
- Meets or exceeds ANSI standard

CR-V

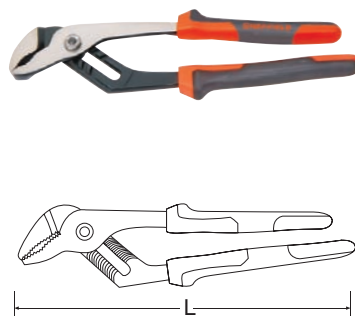

Item no.	Size	L(mm)	
S045009	10"	250	6

双色柄多用斜嘴钳

Diagonal Pliers

- 钳体采用铬钒钢锻造，坚固耐用
- 刃口经特殊处理，剪切能力强
- TPR+PP双材料手柄，握持舒适
- Drop forged steel for longer life and durability
- Heat treated blade, strong shear capacity
- Bi-material comfort grip handle

新品

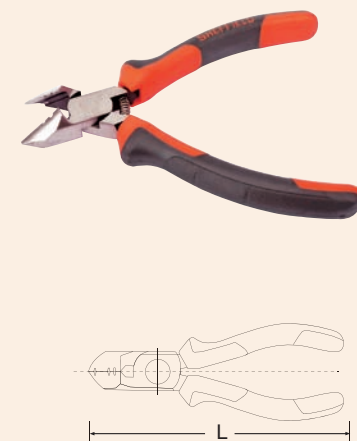

Item no.	Size	L(mm)	
S045015	6"	150	6

双色柄多用尖嘴钳

Long Nose Pliers

- 钳体采用铬钒钢锻造，坚固耐用
- 刃口经特殊处理，剪切能力强
- TPR+PP双材料手柄，握持舒适
- Drop forged steel for longer life and durability
- Heat treated blade, strong shear capacity
- Bi-material comfort grip handle

新品

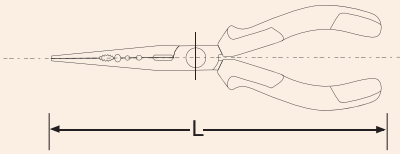

Item no.	Size	L(mm)	
S045016	6"	150	6

专业日式圆腮尖嘴钳

Long Nose Pliers

- 采用优质CR-V材质锻造
- 刃口特殊高频热处理加工，有效保证剪切力及使用寿命
- 钳体精抛光，表面经特殊防锈处理工艺加工，耐用防腐蚀
- 双色PP+TPR手柄，美观舒适
- Made of high quality of Cr-V steel
- Heat treated blade, Strong shear capacity
- body finishing polishing and black finish treatment. durable and anti-corrosion
- Bi-material soft grip handle for comfort

新品



Item no.	Size	L(mm)	
S043004	6"	150	6
S043005	8"	200	6

专业日式钢丝钳

Linesman Pliers

- 采用优质CR-V材质锻造
- 刃口特殊高频热处理加工，有效保证剪切力及使用寿命
- 钳体精抛光，表面经特殊防锈处理工艺加工，耐用防腐蚀
- 双色PP+TPR手柄，美观舒适
- Made of high quality of Cr-V steel
- Heat treated blade, Strong shear capacity
- body finishing polishing and black finish treatment. durable and anti-corrosion
- Bi-material soft grip handle for comfort

新品



Item no.	Size	L(mm)	
S043001	6"	150	6
S043002	7"	175	6
S043003	8"	200	6

专业日式斜嘴钳

Diagonal Pliers

- 采用优质CR-V材质锻造
- 刃口特殊高频热处理加工，有效保证剪切力及使用寿命
- 钳体精抛光，表面经特殊防锈处理工艺加工，耐用防腐蚀
- 双色PP+TPR手柄，美观舒适
- Made of high quality of Cr-V steel
- Heat treated blade, Strong shear capacity
- body finishing polishing and black finish treatment. durable and anti-corrosion
- Bi-material soft grip handle for comfort

新品



Item no.	Size	L(mm)	
S043006	6"	150	6
S043007	7"	175	6
S043008	8"	200	6

重型省力偏心钢丝钳

Heavy Duty Linesman Pliers

- 采用优质CR-NI材质整体锻造，使用寿命比普通钳子更长
- 偏心轴设计，剪切力较普通钳子更加省力
- 依据人体握持习惯，专利设计的不对称工程学手柄，极大提高使用舒适度，减少工作疲劳
- 刃口特殊高频热处理，剪切硬度由普通钳子的HRC35提高至HRC43
- Longer service life than ordinary Pliers.
- Cutting force more efficient than common pliers.
- Ergonomic handle which provides a comfortable and secure grip.
- Heat treatment for blade, hardness improved from HRC35 to HRC43

CR-NI

刃口特殊高频热处理，
剪切硬度由原先HRC35提高至HRC43
Heat treatment for blade, hardness improved
from HRC35 to HRC43



偏心轴设计，剪切更加省力
Eccentric shaft design



依据人体握持习惯，专利设计的
不对称工程学手柄，极大提高使
用舒适度，减少工作疲劳
Ergonomic handle which provides a
comfortable and secure grip

优质CR-NI材质整
体锻造，坚实耐用
use life longer than ordinary Pliers.

Item no.	Size	Capacity(mm)	
S042005	6"	钢丝 2.0	6
S042006	7"	钢丝 2.0	6
S042007	8"	钢丝 2.3	6

重型省力偏心尖嘴钳

Heavy Duty long Nose Pliers

- 采用优质CR-NI材质整体锻造，坚实耐用
- 偏心轴设计，刃口特殊高频热处理，剪切更加省力
- 独特设计双色PP+TPR手柄，握持舒适
- Body forged with high quality CR-NI, durable and longer using life
- Eccentric shaft design, high frequency heat treatment process for cutting edge, much convenient for cutting
- Double color with PP+TPR handle, comfortable for holding

CR-NI

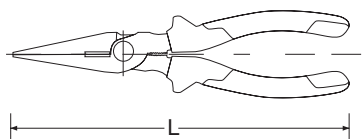

Item no.	Size	Capacity(mm)	
S042001	6"	钢丝 1.6	6
S042002	8"	钢丝 1.6	6

5件套卡簧钳

5-in-1 Circlip Pliers

- 钳头采用优质钢材精加工而成
- 轴用/孔用(45~90度)，范围在10 - 50mm
- 优质橡塑手柄，握持舒适
- Precision-machined high-carbon steel heads
- Interchangeable tips, access from 10 to 50mm, angled at 45 deg, 90 deg and 180 deg
- High grade plastic and Soft grip handle

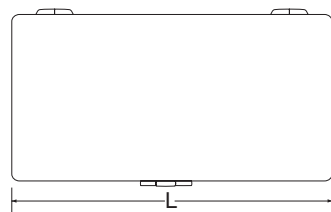

Item no.	Size	L(mm)	
S047001	6"	152	6

德式轴用弯嘴卡簧钳(外卡簧)

Circlip Pliers

- 采用优质铬钒钢锻造，精抛光，发黑处理
- 沾塑手柄，握持舒适
- 符合DIN 5254标准
- Chrome-Vanadium steel, fully polished, black finish
- Double dipped grip handle
- Meets DIN 5254 standard

CR-V

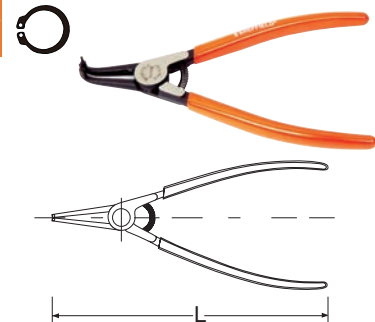

Item no.	Size	L(mm)	Tip Diameter (mm)	Ring Range (mm)	
S047007	7"	175	1.8	19-60	6

德式孔用直嘴卡簧钳(内卡簧)

Circlip Pliers

- 采用优质铬钒钢锻造，精抛光，发黑处理
- 沾塑手柄，握持舒适
- 符合DIN 5254标准
- Chrome-Vanadium steel, fully polished, black finish
- Double dipped grip handle
- Meets DIN 5254 standard

CR-V

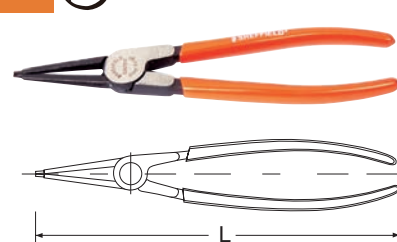

Item no.	Size	L(mm)	Tip Diameter (mm)	Ring Range (mm)	
S047011	7"	175	1.8	19-60	6

重型省力偏心斜嘴钳

Heavy Duty long Nose Pliers

- 采用优质CR-NI材质整体锻造，坚实耐用
- 偏心轴设计，刃口特殊高频热处理，剪切更加省力
- 独特设计双色PP+TPR手柄，握持舒适
- Body forged with high quality CR-NI, durable and longer using life
- Eccentric shaft design, high frequency heat treatment process for cutting edge, much convenient for cutting
- Double color with PP+TPR handle, comfortable for using

CR-NI

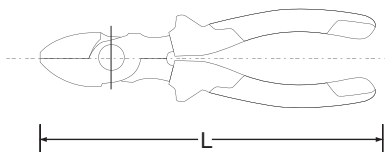

Item no.	Size	Capacity(mm)	
S042003	6"	钢丝 2.0	6
S042004	8"	钢丝 2.0	6

德式轴用直嘴卡簧钳(外卡簧)

Circlip Pliers

- 采用优质铬钒钢锻造，精抛光，发黑处理
- 沾塑手柄，握持舒适
- 符合DIN 5254标准
- Chrome-Vanadium steel, fully polished, black finish
- Double dipped grip handle
- Meets DIN 5254 standard

CR-V

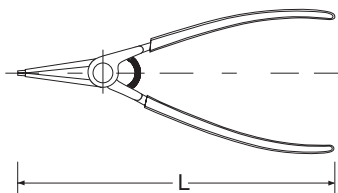

Item no.	Size	L(mm)	Tip Diameter (mm)	Ring Range (mm)	
S047003	7"	175	1.8	19-60	6

德式孔用弯嘴卡簧钳(内卡簧)

Circlip Pliers

- 采用优质铬钒钢锻造，精抛光，发黑处理
- 沾塑手柄，握持舒适
- 符合DIN 5254标准
- Chrome-Vanadium steel, fully polished, black finish
- Double dipped grip handle
- Meets DIN 5254 standard

CR-V

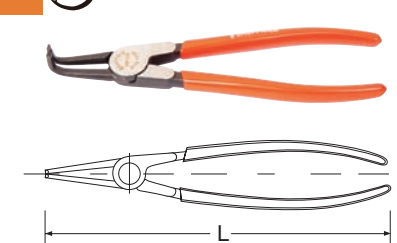

Item no.	Size	L(mm)	Tip Diameter (mm)	Ring Range (mm)	
S047015	7"	175	1.8	19-60	6

美式轴用曲口卡簧钳 (外卡簧)

Circlip Pliers

- 采用优质CR-V材质制造
- 钳体精抛光, 表面发黑处理, 耐用防腐蚀
- 沾塑手柄, 握持舒适
- Made of high quality of CR-V steel
- body finishing polishing and black finish treatment. durable and anti-corrosion.
- dipping handle, grip with comfort

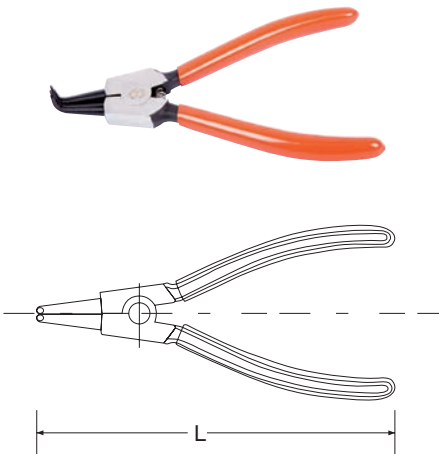

Item no.	Size	Ring Range(mm)	L(mm)	
S047021	5"	8-10	125	6
S047022	7"	19-60	175	6
S047023	9"	32-80	225	6
S047024	13"	65-140	325	6

美式穴用直口卡簧钳 (内卡簧)

Circlip Pliers

- 采用优质CR-V材质制造
- 钳体精抛光, 表面发黑处理, 耐用防腐蚀
- 沾塑手柄, 握持舒适
- Made of high quality of CR-V steel
- body finishing polishing and black finish treatment. durable and anti-corrosion.
- dipping handle, grip with comfort

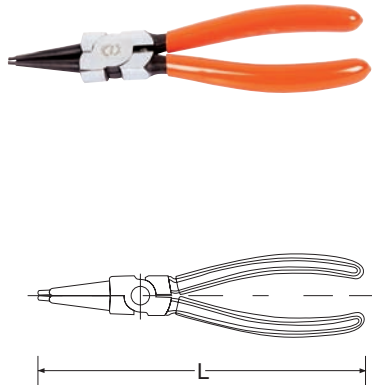

Item no.	Size	Ring Range(mm)	L(mm)	
S047029	5"	8-10	125	6
S047030	7"	19-60	175	6
S047031	9"	32-80	225	6
S047032	13"	65-140	325	6

弧齿大力钳

Curved Jaw Locking Pliers

- 钳口采用优质铬钒钢锻造, 韧性好
- 手柄可快速锁定和释放, 夹持工件不变形
- 安全释放结构保证工作更安全
- 锯齿形钳口带剪切功能
- 螺杆微调钮, 容易调整到最佳尺寸且不变形
- Chrome-Vanadium steel jaw for durability
- Quick, easy locking and release action
- Guarded release helps keep work fast and safe
- Curved jaws with wire cutters
- Turn screw to adjust holding pressure and fit work no deformation

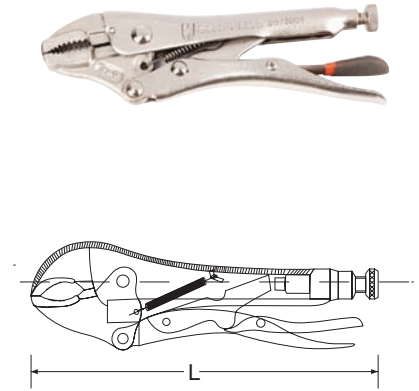

Item no.	Size	L(mm)	
S048001	5"	125	6
S048002	7"	175	6
S048003	10"	250	6

美式轴用直口卡簧钳 (外卡簧)

Circlip Pliers

- 采用优质CR-V材质制造
- 钳体精抛光, 表面发黑处理, 耐用防腐蚀
- 沾塑手柄, 握持舒适
- Made of high quality of CR-V steel
- body finishing polishing and black finish treatment. durable and anti-corrosion.
- dipping handle, grip with comfort

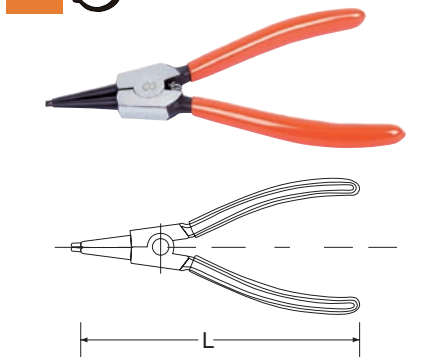

Item no.	Size	Ring Range(mm)	L(mm)	
S047025	5"	8-10	125	6
S047026	7"	19-60	175	6
S047027	9"	32-80	225	6
S047028	13"	65-140	325	6

美式穴用曲口卡簧钳 (内卡簧)

Circlip Pliers

- 采用优质CR-V材质制造
- 钳体精抛光, 表面发黑处理, 耐用防腐蚀
- 沾塑手柄, 握持舒适
- Made of high quality of CR-V steel
- body finishing polishing and black finish treatment. durable and anti-corrosion.
- dipping handle, grip with comfort

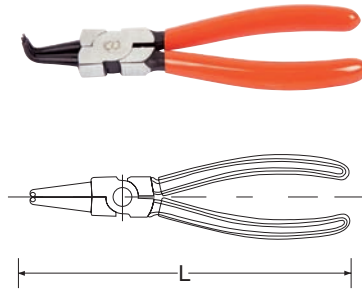

Item no.	Size	Ring Range(mm)	L(mm)	
S047033	5"	8-10	125	6
S047034	7"	19-60	175	6
S047035	9"	32-80	225	6
S047036	13"	65-140	325	6

直齿大力钳

Straight Jaw Locking Pliers

- 钳口采用优质铬钒钢锻造, 韧性好
- 手柄可快速锁定和释放, 夹持工件不变形
- 安全释放结构保证工作更安全
- 螺杆微调钮, 容易调整到最佳尺寸且不变形
- Chrome-Vanadium steel jaw for maximum durability
- Quick, easy locking and release action
- Guarded release helps keep work fast and safe
- Turn screw to adjust holding pressure and fit work no deformation

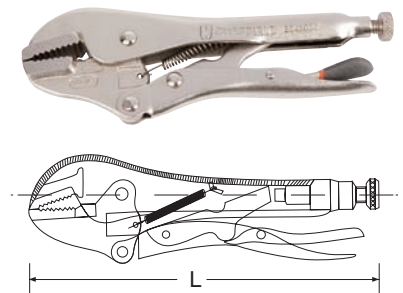

Item no.	Size	L(mm)	
S048004	7"	175	6
S048005	10"	250	6

焊接用大力钳

Welding Locking Pliers

- 钳口采用优质铬钒钢锻造，韧性好
- 手柄可快速锁定和释放，夹持工件不变形
- 安全释放结构保证工作更安全
- 螺杆微调钮，容易调整到最佳尺寸且不变形
- Chrome-Vanadium steel jaw for maximum durability
- Quick, easy locking and release action
- Guarded release helps keep work fast and safe
- Turn screw to adjust holding pressure and fit work no deformation

CR-V

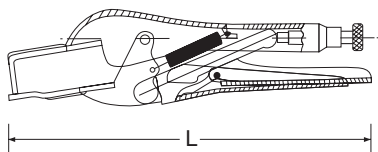

Item no.	Size	L(mm)	
S048008	10"	250	6

铁皮大力钳

Sheet Locking Pliers

- 钳口采用优质铬钒钢锻造，韧性好
- 手柄可快速锁定和释放，夹持工件不变形
- 安全释放结构保证工作更安全
- 螺杆微调钮，容易调整到最佳尺寸且不变形
- Chrome-Vanadium steel jaw for maximum durability
- Quick, easy locking and release action
- Guarded release helps keep work fast and safe
- Turn screw to adjust holding pressure and fit work no deformation

CR-V

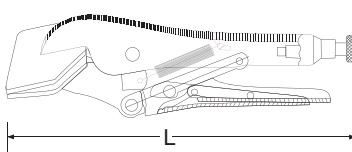

Item no.	Size	L(mm)	
S048009	8"	200	6

链条式大力钳

Chain Clamp Locking Pliers

- 钳口采用优质铬钒钢锻造，韧性好
- 手柄可快速锁定和释放，夹持工件不变形
- 安全释放结构保证工作更安全
- 螺杆微调钮，容易调整到最佳尺寸且不变形
- 适合夹持圆形物体
- Chrome-Vanadium steel jaw for maximum durability
- Quick, easy locking and release action
- Guarded release helps keep work fast and safe
- Turn screw to adjust holding pressure and fit work no deformation
- Secure clamp for round objects

CR-V

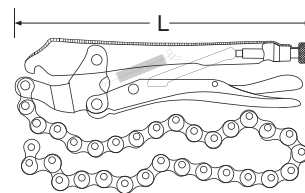

Item no.	Size	L(mm)	
S048011	19"	475	6

尖嘴带刃大力钳

Straight Jaw Locking Pliers

- 钳口采用优质铬钒钢锻造，韧性好
- 长直钳口设计适用狭小工作空间
- 钳口带剪切功能
- 手柄可快速锁定和释放，夹持工件不变形
- 安全释放结构保证工作更安全
- 螺杆微调钮，容易调整到最佳尺寸且不变形
- Chrome-Vanadium steel jaw for maximum durability
- Long nose provides easy access in hard-to-reach places
- Straight jaw with wire cutter
- Quick, easy locking and release action
- Guarded release helps keep work fast and safe
- Turn screw to adjust holding pressure and fit work no deformation

CR-V

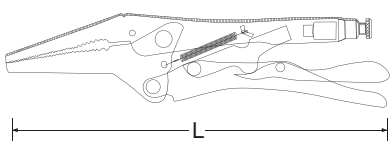

Item no.	Size	L(mm)	
S048006	6.5"	163	6
S048007	9"	225	6

C型大力钳

C-clamp Locking Pliers

- 钳口采用优质铬钒钢锻造，韧性好
- 手柄可快速锁定和释放，夹持工件不变形
- 安全释放结构保证工作更安全
- 螺杆微调钮，容易调整到最佳尺寸且不变形
- Chrome-Vanadium steel jaw for maximum durability
- Quick, easy locking and release action
- Guarded release helps keep work fast and safe
- Turn screw to adjust holding pressure and fit work no deformation

CR-V

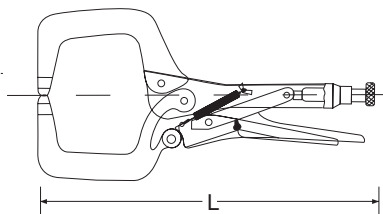

Item no.	Size	L(mm)	
S048010	11"	275	6



大力钳夹持力测试



钢丝钳剪切寿命测试



SHEFFIELD

紧固类工具 **FASTENING TOOLS**

内六角扳手、拉铆枪、硅胶枪、螺丝刀系列、旋具头
Hex Key, Riveter, Cartridge Gun, Screwdriver, Bits

7件套公制标长球头内六角扳手

7Pc Ball End Hex Key Set

- 表面细喷砂镀铬，美观耐磨
- 球形头设计利于多角度操作
- 采用S2优质钢材
- Satin finish, chrome plated
- Ball ends for angled applications
- S2 high quality steel blade

S2



Item no.	Size	
S050001	1.5, 2, 2.5, 3, 4, 5, 6mm	6

9件套公制标长内六角扳手

9Pc Hex Key Set

- 采用S2优质钢材
- 表面细喷砂镀铬，美观耐磨
- S2 high quality steel blade
- Satin finish, chrome plated

S2



Item no.	Size	
S050004	1.5, 2, 2.5, 3, 4, 5, 6, 8, 10mm	6

9件套公制加长球头内六角扳手

9Pc Long Arm Ball End Hex Key Set

- 采用S2优质钢材
- 表面细喷砂镀铬，美观耐磨
- 长刀杆设计，适用狭小空间作业
- 球形头设计利于多角度操作
- S2 high quality steel blade
- Satin finish, chrome plated
- Long design for hard to reach places
- Ball ends for angled applications

S2



Item no.	Size	
S050007	1.5, 2, 2.5, 3, 4, 5, 6, 8, 10mm	6

7件套公制标长内六角扳手

7Pc Hex Key Set

- 表面细喷砂镀铬，美观耐磨
- 采用S2优质钢材
- Satin finish, chrome plated
- S2 high quality steel blade

S2



Item no.	Size	
S050002	1.5, 2, 2.5, 3, 4, 5, 6mm	6

7件套公制加长球头内六角扳手

7Pc Long Arm Ball End Hex Key Set

- 采用S2优质钢材
- 表面细喷砂镀铬，美观耐磨
- 长刀杆设计，适用狭小空间作业
- 球形头设计利于多角度操作
- S2 high quality steel blade
- Satin finish, chrome plated
- Long design for hard-to-reach places
- Ball ends for angled applications

S2

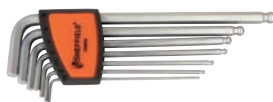

Item no.	Size	
S050005	1.5, 2, 2.5, 3, 4, 5, 6mm	6

9件套公制加长内六角扳手

9Pc Long Arm Hex Key Set

- 采用S2优质钢材
- 表面细喷砂镀铬，美观耐磨
- 长刀杆设计，适用狭小空间作业
- S2 high quality steel blade
- Satin finish, chrome plated
- Long design for hard to reach places

S2



Item no.	Size	
S050008	1.5, 2, 2.5, 3, 4, 5, 6, 8, 10mm	6

9件套公制标长球头内六角扳手

9Pc Ball End Hex Key Set

- 采用S2优质钢材
- 表面细喷砂镀铬，美观耐磨
- 球形头设计利于多角度操作
- S2 high quality steel blade
- Satin finish, chrome plated
- Ball ends for angled applications

S2



Item no.	Size	
S050003	1.5, 2, 2.5, 3, 4, 5, 6, 8, 10mm	6

7件套公制加长内六角扳手

7Pc Long Arm Hex Key Set

- 采用S2优质钢材
- 表面细喷砂镀铬，美观耐磨
- 长刀杆设计，适用狭小空间作业
- S2 high quality steel blade
- Satin finish, chrome plated
- Long design for hard to reach places

S2



Item no.	Size	
S050006	1.5, 2, 2.5, 3, 4, 5, 6mm	6

7件套公制特长球头内六角扳手

7Pc Extra-Long Arm Ball End Hex Key Set

- 采用S2优质钢材
- 表面细喷砂镀铬，美观耐磨
- 长刀杆设计，适用狭小空间作业
- 球形头设计利于多角度操作
- S2 high quality steel blade
- Satin finish, chrome plated
- Long design for hard to reach places
- Ball ends for angled applications

S2



Item no.	Size	
S050009	1.5, 2, 2.5, 3, 4, 5, 6mm	6

7件套公制特长内六角扳手
7Pc Extra-Long Arm Hex Key Set

- 采用S2优质钢材
- 表面细喷砂镀铬, 美观耐磨
- 长刀杆设计, 适用狭小空间作业
- S2 high quality steel blade
- Satin finish, chrome plated
- Long design for hard to reach places

S2

Item no.	Size	
S050010	1.5, 2, 2.5, 3, 4, 5, 6mm	6

12件套英制加长球头内六角扳手
12Pc Long Arm Ball End Hex Key Set

- 采用S2优质钢材
- 表面细喷砂镀铬, 美观耐磨
- 长刀杆设计, 适用狭小空间作业
- 球形头设计利于多角度操作
- S2 high quality steel blade
- Satin finish, chrome plated
- Long design for hard to reach places
- Ball ends for angled applications

S2

Item no.	Size	
S050013	1/16", 5/64", 3/32", 7/64", 1/8", 9/64", 5/32", 3/16", 7/32", 1/4", 5/16", 3/8"	6

9件套加长L型扳手
9Pc Long Arm Torx Key Set

- 采用S2优质钢材
- 表面细喷砂镀铬, 美观耐磨
- 长刀杆设计, 适用狭小空间作业
- S2 high quality steel blade
- Satin finish, chrome plated
- Long design for hard to reach places

S2

Item no.	Size	
S050016	T10, T15, T20, T25, T27, T30, T40, T45, T50	6

9件套公制特长球头内六角扳手
9Pc Extra-Long Arm Ball End Hex Key Set

- 采用S2优质钢材
- 表面细喷砂镀铬, 美观耐磨
- 长刀杆设计, 适用狭小空间作业
- 球形头设计利于多角度操作
- S2 high quality steel blade
- Satin finish, chrome plated
- Long design for hard to reach places
- Ball ends for angled applications

S2

Item no.	Size	
S050011	1.5, 2, 2.5, 3, 4, 5, 6, 8, 10mm	6

12件套英制加长内六角扳手
12Pc Long Hex Key Set

- 采用S2优质钢材
- 表面细喷砂镀铬, 美观耐磨
- 长刀杆设计, 适用狭小空间作业
- S2 high quality steel blade
- Satin finish, chrome plated
- Long design for hard to reach places

S2

Item no.	Size	
S050014	1/16", 5/64", 3/32", 7/64", 1/8", 9/64", 5/32", 3/16", 7/32", 1/4", 5/16", 3/8"	6

8件套迷你型内六角扳手
8Pc Mini Hex Key Set

- 采用S2优质钢材
- 表面细喷砂镀铬, 美观耐磨
- S2 high quality steel blade
- Satin finish, chrome plated

S2

Item no.	Size	
S050017	0.7, 0.9, 1.3, 1.5, 2, 2.5, 3, 4mm	12

8件套链式内六角扳手
8Pc Hex Keys on Ring

- 采用优质铬钒钢
- 表面发黑处理
- Chrome-Vanadium steel blade
- Black finish

CR-V

Item no.	Size	
S050018	1.5, 2, 2.5, 3, 4, 5, 5.5, 6mm	12

9件套公制特长内六角扳手
9Pc Extra-Long Arm Hex Key Set

- 采用S2优质钢材
- 表面细喷砂镀铬, 美观耐磨
- 长刀杆设计, 适用狭小空间作业
- S2 high quality steel blade
- Satin finish, chrome plated
- Long design for hard to reach places

S2

Item no.	Size	
S050012	1.5, 2, 2.5, 3, 4, 5, 6, 8, 10mm	6

8件套加长L型扳手
8Pc Long Arm Torx Key Set

- 采用S2优质钢材
- 表面细喷砂镀铬, 美观耐磨
- 长刀杆设计, 适用狭小空间作业
- S2 high quality steel blade
- Satin finish, chrome plated
- Long design for hard to reach places

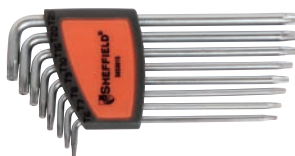
S2

Item no.	Size	
S050015	T6, T7, T8, T9, T10, T15, T20, T25	12

10件套链式内六角扳手
10Pc Hex Keys on Ring

- 采用优质铬钒钢
- 表面发黑处理
- Chrome-Vanadium steel blade
- Black finish

CR-V

Item no.	Size	
S050019	1.5, 2, 2.5, 3, 4, 5, 5.5, 6, 8, 10mm	12

9合1多功能加长球头内六角扳手 9-in-1 Long Arm Ball End Hex Key

- 内六角塑架采用优质材料，多功能设计，增加T柄功能，更便于使用。
- 尾端倒角方便插入螺帽，球型头方便在各种狭窄空间角度使用。
- 整体S2材质制造，硬度、扭力比CR-V更高。
- 雾面镀铬处理外形美观，防锈佳。
- 符合ANSI和DIN标准。
- Hex key holder with T-handle
- Long arm design for hard-to-reach places
- Ball ends for angled applications
- S2 high quality steel blade
- Satin finish, chrome plated
- Meets ANSI & DIN standard

S2



T柄设计，方便使用。
Hex key holder with T-handle



球头设计，方便插入。
Ball ends for angled applications



T型柄功能。
T-handle

Item no.	Size	
S050023	2, 2.5, 3, 4, 5, 6, 7, 8, 10mm	6

8件套折叠式公制球头内六角扳手

- 8Pc Folding Hex Key Set
- 采用优质铬钒钢
 - 表面细喷砂镀铬，美观耐磨
 - Chrome-Vanadium steel blade
 - Satin finish, Chrome plated

CR-V



Item no.	Size	
S050020	1.5, 2, 2.5, 3, 4, 5, 6, 8mm	12

8件套折叠式公制内六角扳手

- 8Pc Folding Hex Key Set
- 采用优质铬钒钢
 - 表面细喷砂镀铬，美观耐磨
 - Chrome-Vanadium steel blade
 - Satin finish, Chrome plated

CR-V



Item no.	Size	
S050021	1.5, 2, 2.5, 3, 4, 5, 6, 8mm	12

8件套折叠式花形内六角扳手

- 8Pc Folding Torx Key Set
- 采用优质铬钒钢
 - 表面细喷砂镀铬，美观耐磨
 - Chrome-Vanadium steel blade
 - Satin finish, chrome plated

CR-V



Item no.	Size	
S050022	T9, T10, T15, T20, T25, T27, T30, T40	12

12件套公制加长球头内六角扳手

- 12Pc Long Arm Ball End Hex Key Set
- 表面细喷砂镀铬，美观耐磨
 - 长刀杆设计，适用狭小空间作业
 - 球形头设计利于多角度操作
 - 采用S2优质钢材
 - Satin finish, chrome plated
 - Extra long design for hard-to-reach places
 - Ball ends for angled applications
 - S2 high quality steel blade

S2



Item no.	Size	
S050024	1.5, 2, 2.5, 3, 4, 5, 6, 7, 8, 10, 12, 14mm	6

12件套公制加长内六角扳手

- 12Pc Long Arm Hex Key Set
- 表面细喷砂镀铬，美观耐磨
 - 长刀杆设计，适用狭小空间作业
 - 采用S2优质钢材
 - Satin finish, chrome plated
 - Extra long design for hard-to-reach places
 - S2 high quality steel blade

S2



Item no.	Size	
S050025	1.5, 2, 2.5, 3, 4, 5, 6, 7, 8, 10, 12, 14mm	6

10件套公制加长球头内六角扳手

- 10Pc Long Arm Ball End Hex Key Set
- 采用S2优质钢材
 - 表面细喷砂镀铬，美观耐磨
 - 长刀杆设计，适用狭小空间作业
 - 球形头设计利于多角度操作
 - S2 blade high quality steel
 - Satin finish, chrome plated
 - Extra long design for hard-to-reach places
 - Ball ends for angled applications

S2



Item no.	Size	
S050026	3, 4, 5, 5.5, 6, 8, 10, 12, 14, 17mm	6

10件套公制加长内六角扳手
10Pc Long Arm Hex Key Set

- 采用S2优质钢材
- 表面细喷砂镀铬，美观耐磨
- 长刀杆设计，适用狭小空间作业
- S2 high quality steel blade
- Satin finish, chrome plated
- Extra long design for hard-to-reach places

S2

Item no.	Size	
S050027	3, 4, 5, 5.5, 6, 8, 10, 12, 14, 17mm	6

公制加长内六角扳手
Long Arm Hex Key

- 采用S2优质钢材
- 表面细喷砂镀铬，美观耐磨
- 长刀杆设计，适用狭小空间作业
- S2 high quality steel blade
- Satin finish, chrome plated
- Long design for hard-to-reach places

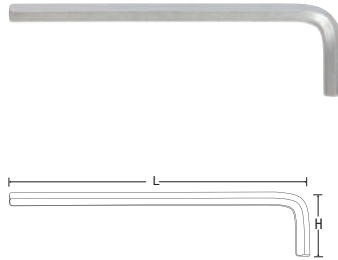
S2

Item no.	Size(mm)	L(mm)	H(mm)	
S050415	1.5	77	13.5	6
S050402	2	82	15.5	6
S050425	2.5	88.5	17.5	6
S050403	3	98.5	19	6
S050404	4	104	24	6
S050405	5	116	27	6
S050455	5.5	126.5	29	6
S050406	6	138	31	6
S050407	7	148	33	6
S050408	8	158	35	6
S050410	10	167	39	3

公制特长内六角扳手
Extra-Long Arm Hex Key

- 采用S2优质钢材
- 表面细喷砂镀铬，美观耐磨
- 长刀杆设计，适用狭小空间作业
- S2 high quality steel blade
- Satin finish, chrome plated
- Extra long design for hard-to-reach places

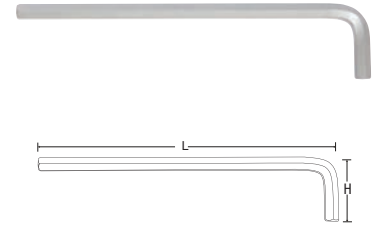
S2

Item no.	Size(mm)	L(mm)	H(mm)	
S050215	1.5	89	13	6
S050202	2	99	15	6
S050225	2.5	111	17	6
S050203	3	125	19	6
S050204	4	139	24	6
S050205	5	159	27	6
S050206	6	179	31	6
S050207	7	189	33	6
S050208	8	199	35	6
S050210	10	223	39	3

公制标长内六角扳手
Hex Key

- 采用S2优质钢材
- 表面细喷砂镀铬，美观耐磨
- S2 high quality steel blade
- Satin finish, chrome plated

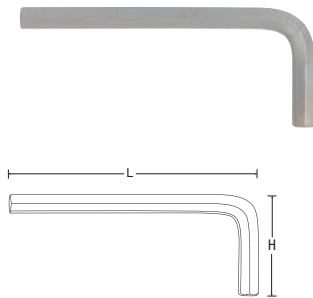
S2

Item no.	Size(mm)	L(mm)	H(mm)	
S050615	1.5	45	14	6
S050602	2	50	16	6
S050625	2.5	56	18	6
S050603	3	63	20	6
S050604	4	70	25	6
S050605	5	80	28	6
S050606	6	90	32	6
S050607	7	95	34	6
S050608	8	100	36	6
S050610	10	112	40	3

公制大规格加长内六角扳手
Long Arm Hex Key

- 采用CR-V优质钢材
- 表面细喷砂镀铬，美观耐磨
- 长刀杆设计，适用狭小空间作业
- CR-V high quality steel blade
- Satin finish, chrome plated
- Long design for hard-to-reach places

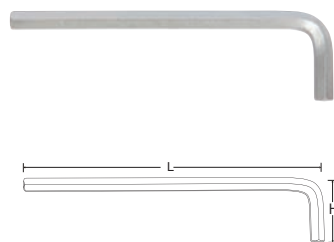
CR-V

Item no.	Size(mm)	L(mm)	H(mm)	
S050412	12	209	44	3
S050414	14	233	54.5	2
S050416	16	240	58.5	6
S050417	17	246	61.5	6
S050418	18	261	64.5	6
S050419	19	276	68.5	6
S050422	22	330	78	12
S050424	24	370	88	12
S050427	27	410	97.5	12

公制标长球头内六角扳手
Ball End Hex Key

- 采用S2优质钢材
- 表面细喷砂镀铬，美观耐磨
- 球形头设计利于多角度操作
- S2 high quality steel blade
- Satin finish, Chrome plated
- Ball ends for angled applications

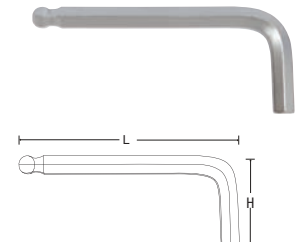
S2

Item no.	Size(mm)	L(mm)	H(mm)	
S050515	1.5	45	14	6
S050502	2	50	16	6
S050525	2.5	56	18	6
S050503	3	63	20	6
S050504	4	70	25	6
S050505	5	80	28	6
S050506	6	90	32	6
S050507	7	95	34	6
S050508	8	100	36	6
S050510	10	112	40	3



内六角扳手、拉铆枪、硅胶枪、螺丝刀系列、旋具头

公制加长球头内六角扳手

Long Arm Ball End Hex Key

- 采用S2优质钢材
- 表面细喷砂镀铬, 美观耐磨
- 长刀杆设计, 适用狭小空间作业
- 球形头设计利于多角度操作
- S2 high quality steel blade
- Satin finish, chrome plated
- Long design for hard-to-reach places
- Ball ends for angled applications

S2

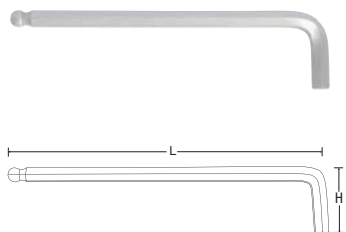

Item no.	Size(mm)	L(mm)	H(mm)	
S050315	1.5	77	13.5	6
S050302	2	82	15.5	6
S050325	2.5	88.5	17.5	6
S050303	3	98.5	19	6
S050304	4	104	24	6
S050305	5	116	27	6
S050355	5.5	126.5	29	6
S050306	6	138	31	6
S050307	7	148	33	6
S050308	8	158	35	6
S050310	10	167	39	3

公制特长球头内六角扳手

Extra-Long Arm Ball End Hex Key

- 采用S2优质钢材
- 表面细喷砂镀铬, 美观耐磨
- 长刀杆设计, 适用狭小空间作业
- 球形头设计利于多角度操作
- S2 high quality steel blade
- Satin finish, chrome plated
- Extra long design for hard-to-reach places
- Ball ends for angled applications

S2

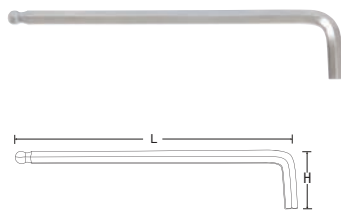

Item no.	Size(mm)	L(mm)	H(mm)	
S050115	1.5	89	13	6
S050102	2	99	15	6
S050125	2.5	111	17	6
S050103	3	125	19	6
S050104	4	139	24	6
S050105	5	159	27	6
S050106	6	179	31	6
S050107	7	189	33	6
S050108	8	199	35	6
S050110	10	223	39	3

加长L型带中孔花形扳手

Long Arm Torx Key

- 刀杆带中孔设计
- 采用S2优质钢材
- 表面细喷砂镀铬, 美观耐磨
- 长刀杆设计, 适用狭小空间作业
- Hollow tamperproof torx keys
- S2 blade
- Satin finish, chrome plated
- Design for hard-to-reach places

S2

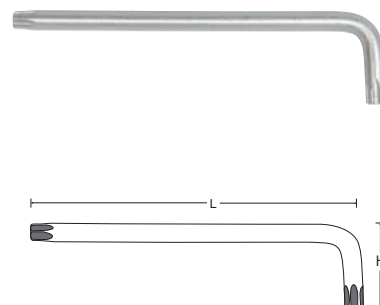

Item no.	Size	L(mm)	H(mm)	
S050706	T6	70	13	6
S050707	T7	74	14	6
S050708	T8	78	15	6
S050709	T9	82	16	6
S050710	T10	86	17	6
S050715	T15	90	18	6
S050720	T20	95	19	6
S050725	T25	100	20	6
S050727	T27	105	21	6
S050730	T30	114	24	6
S050740	T40	124	26	6
S050745	T45	133	29	6
S050750	T50	152	32	6
S050755	T55	171	35	3

公制大规格加长球头内六角扳手

Long Arm Ball End Hex Key

- 采用CR-V优质钢材
- 表面细喷砂镀铬, 美观耐磨
- 长刀杆设计, 适用狭小空间作业
- 球形头设计利于多角度操作
- CR-V high quality steel blade
- Satin finish, chrome plated
- Long design for hard-to-reach places
- Ball ends for angled applications

CR-V

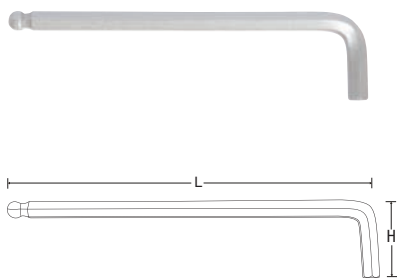

Item no.	Size(mm)	L(mm)	H(mm)	
S050312	12	209	44	3
S050314	14	233	54.5	2
S050317	17	246	61.5	6

英制加长球头内六角扳手

Long Arm Ball End Hex Key

- 采用S2优质钢材
- 表面细喷砂镀铬, 美观耐磨
- 长刀杆设计, 适用狭小空间作业
- 球形头设计利于多角度操作
- Satin finish, chrome plated
- Design for hard-to-reach places
- Ball ends for angled applications
- S2 blade

S2

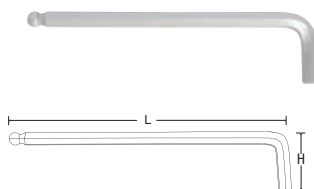

Item no.	Size	L(mm)	H(mm)	
S051004	1/16"	76	14	6
S051005	5/64"	81	15	6
S051006	3/32"	86	17	6
S051007	7/64"	90	18	6
S051008	1/8"	95	19	6
S051009	9/64"	100	20	6
S051010	5/32"	105	21	6
S051012	3/16"	114	24	6
S051014	7/32"	124	26	6
S051016	1/4"	135	28	6
S051020	5/16"	152	32	6
S051024	3/8"	171	35	3



公制T型内六角扳手

T Handle Hex Key

- 采用S2优质钢材
- T型手柄使扭力更强
- 表面细喷砂镀铬，美观耐磨
- 手柄握持舒适
- S2 blade
- T-handle gives extra torque power
- Satin finish, chrome plated
- Bi-Material comfort grip handle

S2

Item no.	Size(mm)	
S050902	2	12
S050925	2.5	12
S050903	3	12
S050904	4	12
S050905	5	12
S050906	6	12
S050907	7	12
S050908	8	12
S050910	10	12

双把手拉铆枪

Heavy Duty Riveter

- 铝合金拉铆枪头
- 铬钼钢爪片
- 加长手柄，操作更省力
- 塑料瓶用于存放拉断的铆钉
- 适用铆钉尺寸：3.2mm, 4.0mm, 4.8mm, 6.0mm, 6.4mm
- 配有用于更换铆嘴的扳手
- Aluminum alloy steel head
- Chrome moly jaws
- Extra long handles provide excellent leverage
- Lightweight plastic bottle catches rivet stems
- Fits rivet sizes: 1/8", 5/32", 3/16", 7/32", and 1/4"
- Equipped with replacement a wrench

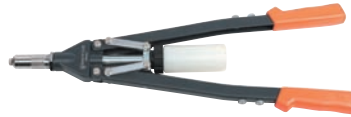

Item no.	Size(mm)	
S052001	3.2, 4.0, 4.8, 6.0, 6.4	1

铝合金拉铆枪

Aluminum Riveter

- 铬钼钢爪片
- 铝合金本体，人体工程学手柄套加厚加长
- 带弹簧手柄能自如压出铆钉
- 适用铆钉尺寸：2.4mm, 3.2mm, 4.0mm, 4.8mm
- 手柄内侧配有用于更换铆嘴的扳手
- Chrome moly jaws
- Aluminum alloy construction with ergonomic grip handle
- Spring loaded handle ejects rivet stem automatically
- Fits rivet sizes: 3/32", 1/8", 5/32", and 3/16"
- One wrench stored in handle



Item no.	Size(mm)	
S052003	2.4, 3.2, 4.0, 4.8	6

公制T型球头内六角扳手

T Handle Ball End Hex Key

- 采用S2优质钢材
- T型手柄使扭力更强
- 表面细喷砂镀铬，美观耐磨
- 球形头设计利于多角度操作
- 手柄握持舒适
- S2 blade
- T-handle gives extra torque power
- Satin finish, chrome plated
- Ball ends for angled applications
- Bi-Material comfort grip handle

S2

Item no.	Size(mm)	
S050802	2	12
S050825	2.5	12
S050803	3	12
S050804	4	12
S050805	5	12
S050806	6	12
S050807	7	12
S050808	8	12
S050810	10	12

拉铆枪

Riveter

- 铬钼钢爪片
- 人体工程学手柄套加厚加长
- 带弹簧手柄能自如压出铆钉
- 适用铆钉尺寸：2.4mm, 3.2mm, 4.0mm, 4.8mm
- 手柄内侧配有用于更换铆嘴的扳手
- Chrome moly jaws
- Steel construction with ergonomic grip handle
- Spring loaded handle ejects rivet stem automatically
- Fits rivet sizes: 3/32", 1/8", 5/32", and 3/16"
- One wrench stored in handle



Item no.	Size(mm)	
S052002	2.4, 3.2, 4.0, 4.8	6

轻型双把手拉铆枪

Hand Riveter

- 三片式铬钼合金钢材爪片，使用寿命长，强度大
- 枪头采用优质钢材，手柄采用2.5mm厚度板材，可轻松拉断不锈钢铆钉
- 外套筒可调节工作行程，配备5颗导嘴：3.2, 4.0, 4.8, 6.0, 6.4mm及一把拆卸扳手，方便更换
- 集钉瓶可回收钉芯，保持工作环境安全，整洁
- 人体工学设计手柄，操作舒适
- Three-claw, CR-MO alloy steel construction for longer life and strength
- Ideal for pulling off stainless steel & aluminum riveters
- Includes 5 nosepieces: 3.2, 4.0, 4.8, 6.0, 6.4mm and a removable wrench
- Comes with plastic "rivet-end-waste" collector for safety and easy disposal
- Ergonomic designed handle for comfort



Item no.	Size(mm)	
S052004	3.2, 4.0, 4.8, 6.0, 6.4	1



内六角扳手、拉铆枪、硅胶枪、螺丝刀系列、旋具头

硅胶枪

Cartridge Gun

- 优质锌合金手柄，高级锌合金材质推块，高强度，寿命长
- 优质冷轧钢板枪体，推杆整体热处理，坚固，耐用
- 360度旋转枪体，适合狭小、角落及夹缝空间使用
- Qualified zinc alloy handle for high intensive and long life usage
- Qualified cold-steel body, heat treated rod for durability
- 360° swivel body fits into hard-to-reach & confined spaces



Item no.	Size	
S052011	9"	6

充磁及退磁器

Magnetizer/Demagnetizer

- 高强度环保ABS塑料外壳，抗冲击
- 用于对螺丝批刀杆和类似铁制工具的充磁或退磁
- ABS plastic shell
- Magnetizing or demagnetising most steel screwdrivers or other small tools

新品



Item no.	Size	
S059100	51x50x29mm	12

一字彩条柄螺丝批

Slotted Screwdriver

- 刀杆采用优质钢材，表面镀铬处理
- 批头发黑处理，带强磁
- 手柄符合人体工学设计，握持舒适
- blade, Chrome plated
- Black magnetic tip
- Ergonomic comfort grip handle
- Qualified zinc alloy handle for high intensive and long life usage
- Qualified cold-steel body, heat treated rod for durability
- 360° swivel body fits into hard-to-reach & confined spaces

CR-V

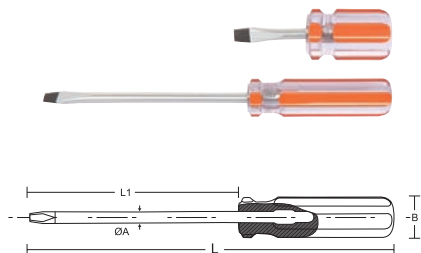

Item no.	Size (mm)	A (mm)	L1 (mm)	L (mm)	B (mm)	C (mm)	D (mm)	
S055101	3x75	3	75	135	16	3	0.7	12
S055102	3x100	3	100	160	16	3	0.7	12
S055103	3x150	3	150	210	16	3	0.7	12
S055104	3x200	3	200	260	16	3	0.8	12
S055105	5x75	5	75	165	24	5.3	1	12
S055106	5x100	5	100	190	24	5.4	1.1	12
S055107	5x150	5	150	240	24	5.2	0.8	12
S055108	5x200	5	200	290	23.5	5	0.8	12
S055109	5x250	5	250	340	24	5.3	0.9	12
S055110	6x38	6	38	86	27.7	6.7	1.1	12
S055111	6x100	6	100	195	27.7	6.5	1	12
S055112	6x150	6	150	245	27	6.5	1	12
S055113	6x200	6	200	295	27.3	6.5	1	12
S055114	6x250	6	250	345	27.2	6.7	1.2	12
S055115	8x150	8	150	255	27.4	8.2	1.6	12
S055116	8x200	8	200	305	27.2	8.2	1.3	12

十字彩条柄螺丝批

Phillips Screwdriver

- 刀杆采用优质钢材，表面镀铬处理
- 批头发黑处理，带强磁
- 手柄符合人体工学设计，握持舒适
- blade, Chrome plated
- Black magnetic tip
- Ergonomic comfort grip handle

CR-V

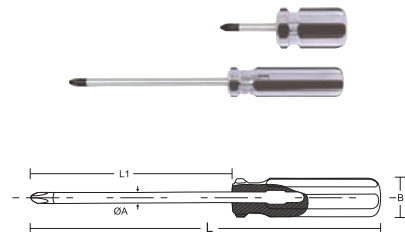

Item no.	Size (mm)	A (mm)	L1 (mm)	L (mm)	B (mm)	
S055201	PH0x75	3	75	135	16	12
S055202	PH0x100	3	100	160	16	12
S055203	PH0x150	3	150	210	15.5	12
S055204	PH0x200	3	200	260	15	12
S055205	PH1x75	5	75	165	24	12
S055206	PH1x100	5	100	190	24	12
S055207	PH1x150	5	150	240	24	12
S055208	PH1x200	5	200	290	23.5	12
S055209	PH1x250	5	250	340	24	12
S055210	PH2x38	6	38	86	27.7	12
S055211	PH2x100	6	100	195	27.7	12
S055212	PH2x150	6	150	245	27	12
S055213	PH2x200	6	200	295	27.3	12
S055214	PH2x250	6	250	345	27.2	12
S055215	PH3x150	8	150	255	27.4	12
S055216	PH3x200	8	200	305	27.2	12

重型硅胶枪

Heavy Duty Cartridge Gun

- 优质锌合金手柄，TPR橡胶包胶护套，握持舒适，抗冲击，耐用
- 高级锌合金材质推块，优质冷轧钢板枪体，高强度，寿命长
- 独特推杆锁紧装置，可轻松更换硅胶，使用方便
- 手柄处独有增加切削刀片，方便，省力
- 360度旋转枪体，适合狭小、角落及夹缝空间使用
- Zinc alloy handle with soft TPR for comfort & durability
- Quality cold-steel body for long life
- Unique locking system for easy change
- Tip cutter function in the handle for easy cutting of pipe tips
- 360° swivel body fits into hard-to-reach & confined spaces



Item no.	Size	
S052012	9"	6

2件套吊卡式螺丝批

2Pc Screwdriver Set

- 刀杆采用Cr-V-Mo优质钢材，表面镀铬处理
- 批头发黑处理，带强磁
- 手柄符合人体工学设计，握持舒适
- Cr-V-Mo blade, Chrome plated
- Black magnetic tip
- Ergonomic comfort grip handle

CR-V-MO 升级



Item no.	Size	
S056001	6 x 100mm, PH2 x 100mm	24

5件套花型胶柄螺丝批电讯电子套装

5Pc Screwdriver Set

- 刀杆采用Cr-V-Mo优质钢材，表面镀铬处理
- 手柄符合人体工程学设计，握持舒适
- 批头带强磁
- Cr-V-Mo blade, Chrome plated
- Ergonomic comfort grip handle
- Magnetic tip



Item no.	Size	
S056002	T5, T6, T8, T10, T15x75mm	12

4件套吊卡式螺丝批

4Pc Screwdriver Set

- 刀杆采用Cr-V-Mo优质钢材，表面镀铬处理
- 批头发黑处理，带强磁
- 手柄符合人体工程学设计，握持舒适
- Cr-V-Mo blade, Chrome plated
- Black magnetic tip
- Ergonomic comfort grip handle



Item no.	
S056003	24
十字 / Phillips: #1 x 100mm, #2 x 150mm,	
一字 / Slotted: 5 x 100mm, 6 x 150mm	

6件套超值装螺丝批

6Pc Screwdriver Set

- 刀杆采用Cr-V-Mo优质钢材，表面镀铬处理
- 批头发黑处理，带强磁
- 手柄符合人体工程学设计，握持舒适
- Cr-V-Mo blade, Chrome plated
- Black magnetic tip
- Ergonomic comfort grip handle



Item no.	
S056005	12
十字 / Phillips: #1 x 100mm, #2 x 150mm	
一字 / Slotted: 5 x 100mm(平行), 5 x 100mm, 5 x 150mm, 6 x 150mm	

8件套超值装螺丝批

8Pc Screwdriver Set

- 刀杆采用Cr-V-Mo优质钢材，表面镀铬处理
- 批头发黑处理，带强磁
- 手柄符合人体工程学设计，握持舒适
- Cr-V-Mo blade, Chrome plated
- Black magnetic tip
- Ergonomic comfort grip handle



Item no.	
S056006	12
十字 / Phillips: #0 x 50mm, #1 x 100mm, #2 x 150mm, #2 x 45mm	
一字 / Slotted: 3 x 75mm, 5 x 100mm, 6 x 150mm, 6mm x 40mm	

8件套双色柄螺丝批组套

8Pc Screwdriver Set

- 双色PP+TPR手柄，美观舒适
- 刀杆采用优质CR-V-Mo材质，表面镀铬处理
- Bi-material soft grip handle for comfort
- CR-v-mo blade, Chrome plated



Item no.	
S056007	4
十字 / Phillips: #1x75mm, #2x45mm, #2x100mm, #2x150mm	
一字 / Slotted: 5x75mm, 6x40mm, 6x100mm, 6x150mm	

8件套双色花型螺丝批组套

8PC Torx Screwdriver Set

- 双色PP+TPR手柄，美观舒适
- 刀杆采用优质CR-V-Mo材质，表面镀铬处理
- Bi-material soft grip handle for comfort
- Cr-v-mo blade, Chrome plated



Item no.	
S056008	4
T6X100mm, T8X100mm, T10X100mm, T15X100mm,	
T20X100mm, T25X100mm, T30X100mm, T40X100mm	

6件套双色柄螺丝批组套

6Pc Screwdriver Set

- 双色PP+TPR手柄，美观舒适
- 刀杆采用优质CR-V-Mo材质，表面镀铬处理
- Bi-material soft grip handle for comfort
- Cr-v-mo blade, Chrome plated



Item no.	
S056009	4
十字 / Phillips: #1X75mm, #2X100mm, #2X150mm	
一字 / Slotted: : 5X75mm, 5X100mm, 6X150mm	



内六角扳手、拉铆枪、硅胶枪、螺丝刀系列、旋具头

16件多用旋具组套

16Pc Screwdriver Set

- 采用S2优质材质，超强硬度扭力
- 表面镀铬处理，耐用
- Blades made from high grade S2 alloy steel
- Nickel plated for rust-resistant

S2



Item no.	Contents	
S056011	16Pc	12
3件	6.3mm系列25mm长一字旋具头：4, 5.5, 6.5mm	
3件	6.3mm系列25mm长十字旋具头：PH1, PH2, PH3	
4件	6.3mm系列25mm长六角旋具头：H3, H4, H5, H6	
4件	6.3mm系列25mm长花型旋具头：T8, T10, T15, T20	
2件	6.3mm系列旋柄；6.3mm系列起子变头头	

双色柄一字头螺丝刀

Slotted Screwdriver

- 刀杆采用Cr-V-Mo优质钢材，表面镀铬处理
- 批头发黑处理，带强磁
- 手柄符合人体工程学设计，握持舒适
- CR-V-Mo blade, Chrome plated
- Black magnetic tip
- Ergonomic comfort grip handle

CR-V-MO **升级**



Item no.	Size (mm)	A (mm)	L1 (mm)	L (mm)	B (mm)	C (mm)	D (mm)	
S056101	3x50	3	50	140	23	3	0.7	12
S056102	3x75	3	75	165	23	3	0.7	12
S056103	3x100	3	100	190	23	3	0.7	12
S056104	3x150	3	150	240	24	3	0.7	12
S056105	3x200	3	200	290	31	5.5	1	12
S056106	5x75	5	75	175	31	5.5	1	12
S056107	5x100	5	100	200	31	5.5	1	12
S056108	5x125	5	125	225	31	5.5	1	12
S056109	5x150	5	150	250	31	5.5	1	12
S056110	5x200	5	200	300	31	5.5	1	12
S056111	5x250	5	250	350	31	5.5	1	12
S056112	6x40	6	40	100	35	6.3	1.2	12
S056113	6x100	6	100	210	38	6.5	1.2	12
S056114	6x125	6	125	235	38	6.5	1.2	12
S056115	6x150	6	150	260	38	6.5	1.2	12
S056116	6x200	6	200	310	37	6.5	1.2	12
S056117	6x250	6	250	360	38	6.5	1.2	12
S056118	6x300	6	300	410	38	6.5	1.3	12
S056119	8x150	8	150	270	40	8	1.6	12
S056120	8x200	8	200	320	40	8	1.6	12
S056121	8x250	8	250	370	40	8	1.6	12
S056122	8x300	8	300	420	40	8	1.6	12

双色柄螺帽螺丝批

Nut Drivers

- 刀杆采用优质CR-V材质，雾面镀铬处理
- 双色PP+TPR手柄，握持舒适
- Blade of high quality CR-V steel, chrome plated
- Bi-material soft grip handle for comfort

CR-V **升级**

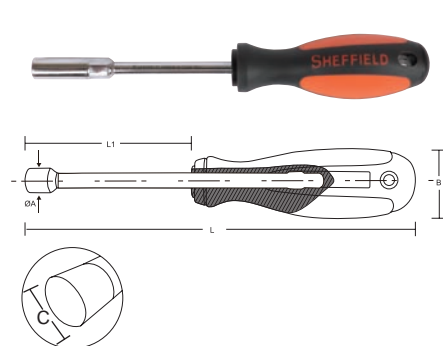

Item no.	Size (mm)	A (mm)	L1 (mm)	L (mm)	B (mm)	C (mm)	
S056703	5x75	5	75	190	38	8.4	12
S056705	6x75	6	75	190	38	9.5	12
S056706	7x75	7	75	190	38	10.6	12
S056707	8x75	8	75	190	37	12	12
S056708	10x75	10	75	190	40	14.2	12

花型双色柄螺丝刀

Torx Screwdriver

- 刀杆采用Cr-V-Mo优质钢材，表面镀铬处理
- 批头发黑处理，带强磁
- 手柄符合人体工程学设计，握持舒适
- CR-v-mo blade, Chrome plated
- Black magnetic tip
- Ergonomic comfort grip handle

CR-V-MO **升级**



Item no.	Size(mm)	A(mm)	L1(mm)	L(mm)	B(mm)	
S056301	T5x100	3	100	190	24	12
S056302	T6x100	3	100	190	24	12
S056303	T8x100	3	100	200	24	12
S056304	T10x100	3	100	200	24	12
S056305	T15x100	4	100	200	24	12
S056306	T20x100	4	100	200	24	12
S056307	T25x100	5	100	200	31	12
S056308	T27x100	5	100	200	38	12
S056309	T30x100	6	100	200	41	12
S056310	T40x100	8	100	200	31	12

双色柄十字头螺丝刀

Phillips Screwdriver

- 刀杆采用CR-V-Mo优质钢材，表面镀铬处理
- 批头发黑处理，带强磁
- 手柄符合人体工程学设计，握持舒适
- CR-V-Mo blade, Chrome plated
- Black magnetic tip
- Ergonomic comfort grip handle

CR-V-MO **升级**

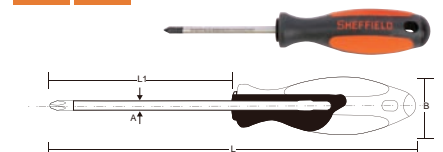

Item no.	Size(mm)	A(mm)	L1(mm)	L(mm)	B(mm)	
S056201	PH0x50	3	50	140	23.5	12
S056202	PH0x75	3	75	165	23.5	12
S056203	PH0x100	3	100	190	23.7	12
S056204	PH0x150	3	150	240	24	12
S056205	PH0x200	3	200	290	24	12
S056206	PH1x75	5	75	175	31	12
S056207	PH1x100	5	100	200	31	12
S056208	PH1x125	5	125	225	31	12
S056209	PH1x150	5	150	250	31	12
S056210	PH1x200	5	200	300	31	12
S056211	PH1x250	5	250	350	31	12
S056212	PH2x45	6	40	100	30.6	12
S056213	PH2x100	6	100	210	37.4	12
S056214	PH2x125	6	125	235	37.7	12
S056215	PH2x150	6	150	260	37.7	12
S056216	PH2x200	6	200	310	38	12
S056217	PH2x250	6	250	360	38	12
S056218	PH2x300	6	300	410	38	12
S056219	PH3x150	8	150	270	41	12
S056220	PH3x200	8	200	320	41	12
S056221	PH3x250	8	250	370	41	12
S056222	PH3x300	8	300	420	41	12

双色柄平行一字头螺丝批

Slotted Screwdriver

- 刀杆采用Cr-V-Mo优质钢材，表面镀铬处理
- 批头发黑处理，带强磁
- 手柄符合人体工程学设计，握持舒适
- CR-V-Mo blade, Chrome plated
- Black magnetic tip
- Ergonomic comfort grip handle

CR-V-MO **升级**



Item no.	Size (mm)	A (mm)	L1 (mm)	L (mm)	B (mm)	C (mm)	D (mm)	
S056401	2x50	2	50	140	23.5	2.4	0.4	12
S056402	2.5x50	2.5	50	140	23.5	2.4	0.4	12
S056403	2.5x75	2.5	75	165	23.5	2.4	0.4	12
S056404	3x75	3	75	165	23.6	3	0.6	12
S056405	3x100	3	100	190	23.6	3	0.6	12
S056406	3.5x75	3.5	75	165	23.8	3.5	0.6	12
S056407	3.5x100	3.5	100	190	23.9	3.4	0.7	12
S056408	3.5x250	3.5	250	340	24	3.5	0.7	12
S056409	4x100	4	100	190	23.6	4	0.8	12
S056410	4x150	4	150	240	23.7	4	0.8	12
S056411	4x200	4	200	290	23.8	4	0.8	12
S056412	4x300	4	300	390	23.7	4	0.9	12
S056413	5x100	5	100	200	31	5	1	12
S056414	5x150	5	150	250	31.5	5.2	1.2	12
S056415	5x200	5	200	300	31.3	5	0.9	12
S056416	5x250	5	250	350	31.3	5	0.9	12
S056417	5x300	5	300	400	31.3	5	1	12
S056418	6x150	6	150	260	38	6.1	1.3	12
S056419	6x200	6	200	310	37.4	6	1.3	12
S056420	6x300	6	300	410	37.6	6.2	1.3	12

28件套专利双倍速棘轮螺丝刀组套 28Pc Screwdriver Set

- 双向棘轮结构，轻松换向，方便操作
- 特有航空铝材质护套，TPR软性塑胶护套，工程设计，握持舒适
- 铝合金材质棘轮结构，S2材质刀杆，更长使用寿命
- 专利双倍速棘轮设计，高效省时，是普通棘轮螺丝批使用速度的2倍
- Dual-drive which easy fortwist back and forth
- Ergonomic aero-aluminium handle with slip-resistant rubber grip.
- Zinc alloy material for ratchet, S2 for blade, longer lifetime.
- Patent dual-driver technology 2xfaster than standed ratchting.



尾端可储存批头，使用方便



扫描二维码
观看产品介绍视频

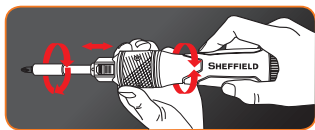

专利双倍速棘轮设计，左右旋转手柄，刀头能持续转动，工作效率是普通棘轮螺丝刀的2倍
Patent dual-driver technology 2xfaster than standed ratchting. the bits keep on moving, because they keep on moving, it drives screw twice as fast as ratcheting driver



双向棘轮推钮，可轻松换向，航空铝合金护套，坚固耐用
Dual-drive which easily fortwist back and forth. aero-aluminium handle, firmness durability



配备各种S2材质批头，更多使用选择，更长使用寿命
S2 for blade, longer service life, more using choices selections more make use of work

Item no.

S056510



6

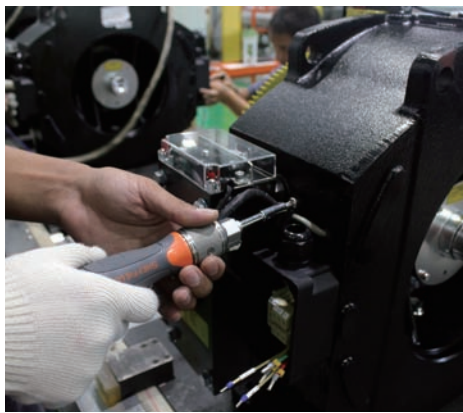

6用棘轮铝合金手柄螺丝刀 Aluminum Screwdriver

- 滚花镶嵌手柄，产生更大扭矩，磁性刀头接口，可迅速有效地装卸刀头
- 重型铝合金手柄，表面氧化处理，握持舒适，美观大方
- 刀杆表面镀铬处理，抗腐蚀
- 高品质，三定位（正转、反转、定转）棘轮螺丝刀
- Chrome plated shaft for rust-resistant
- Heavy duty anodize aluminum handle with rubber enashed
- 3 Position high torque ratchet



多功能设计，便捷快速。

6-in-1 design



镶嵌TPR滚花手柄，扭矩更大，舒适耐用。
Heavy duty anodize aluminum handle with rubber enashed



双向棘轮设计，三定位功能。
3 position high torque ratchet

Item no.

S056508

可换双头旋具头

十字 / Phillips: PH1, PH2; 一字 / Slotted: 5mm, 6mm
套筒 / Nutdriver: 1/4", 5/16"



6

27件棘轮螺丝刀紧固套装

27Pc Screwdriver Set

- 刀头采用S2优质钢材，经久耐用
- 刀杆表面镀铬，抗锈性好
- 重型铝合金螺丝批手柄表面电镀，镶嵌橡胶，握持舒适
- 棘轮头可以转向，以0度，45度，90度角操作
- S2 bits for durability
- Chrome plated shaft for rust-resistant
- Heavy duty anodize aluminum handle with rubber enashed
- Pivoting ratchet drive for 0, 45 & 90-Degree operation

S2



Item no.

S056501



6

1件 三用活头棘轮螺丝批

16件 25mm系列螺丝批头

一字 / Slotted: 3, 4, 5, 6mm; 十字 / Phillips: #0, #1, #2, #3

花型 / Star: T10, T15, T20, T25; 六角 / Hex: 3, 4, 5, 6mm

10件 50mm长螺丝批头

一字 / Slotted: 3, 5, 6mm; 十字 / Phillips: #1, #2, #3

花型 / Star: T10, T15, T20, T25

25件棘轮螺丝刀紧固套装

25Pc Screwdriver Set

- 刀头采用S2优质钢材，经久耐用
- 刀杆表面镀铬，抗锈性好
- 重型铝合金螺丝批手柄表面电镀，镶嵌橡胶，握持舒适
- 棘轮头可以转向，以0度，45度，90度角操作
- 附赠牛津布腰包
- S2 bits for durability
- Chrome plated shaft for rust-resistant
- Heavy duty anodized aluminum handle with rubber enmeshed
- Pivoting ratchet drive for 0, 45 and 90-Degree operation
- Pouch included



Item no.		
S056502		6
1件	三用活头棘轮螺丝批	
6件	6.3mm系列强力套筒 4, 5, 6, 8, 9, 10mm	
18件	25mm系列螺丝批头	
	一字 / Slotted: 3, 4, 5, 6mm	
	十字 / Phillips: PH1×2pc, PH2×3pc, PH3×2pc	
	米字 / Pozidriv: PZ1, PZ2, PZ3	
	花型 / Star: T10, T15, T20, T25	

13合1棘轮铝合金手柄螺丝刀

13-in-1 Aluminum Screwdriver Set

- 刀头采用S2优质钢材，经久耐用
- 刀杆表面镀铬，抗锈性好
- 重型铝合金手柄表面电镀，镶嵌橡胶，握持舒适
- 带双向棘轮，使用更省力快捷
- S2 bits for durability
- Chrome plated shaft for rust-resistant
- Heavy duty anodized aluminum handle with rubber enmeshed
- 3 position high torque ratchet

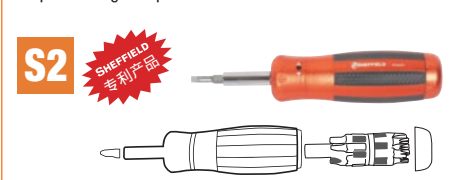

Item no.		
S056505		6
可换旋具头		
十字 / Phillips: #0, #1, #2, #3; 一字 / Slotted: 3, 4, 5, 6mm		
花形 / Torx: T10, T15, T20, T25		
磁性接杆 / Magnetic holder		

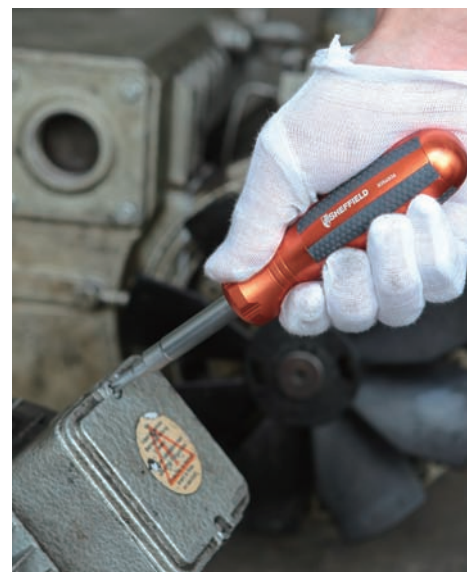

10件套多用换头螺丝刀

10Pc Screwdriver Set

- 符合人体工学设计
- 铬钒钢刀杆
- 手柄防滑，握持舒适
- PP底座，方便摆放手柄和刀杆
- Ergonomic design
- Chrome vanadium steel blade
- Comfort non-slip grip
- PP base for storage



Item no.		
S056503		15
一字 / Slotted: 1/8", 3/16", 1/4";		
十字 / Phillips: PH0, PH1, PH2		
尖头 / AWL; 勾头 / Nail&tack puller; 换头胶柄 / Handle		

6用铝合金手柄螺丝刀

Aluminum Screwdriver

- 刀头采用CR-V优质钢材，经久耐用
- 刀杆表面镀铬，抗锈性好
- 重型铝合金手柄表面电镀，镶嵌橡胶，握持舒适
- CR-V bits for durability
- Chrome plated shaft for rust-resistant
- Heavy duty anodized aluminum handle with rubber enmeshed



Item no.		
S056506		6
可换双头旋具头		
十字 / Phillips: #1, #2; 一字 / Slotted: 5, 6mm		
套筒 / Nutdriver: 1/4", 5/16"		

一字通体螺丝刀

Slotted Screwdriver

- 刀杆采用S2优质钢材，表面镀铬处理
- 刀头发黑处理，带强磁
- 贯通式刀杆，适于敲击使用
- 手柄符合人体工学设计，握持舒适
- S2 blade, Chrome plated
- Black magnetic tip
- Steel striking cap
- Ergonomic comfort grip handle

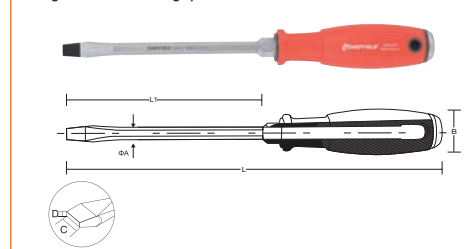

Item no.	Size (mm)	A (mm)	L1 (mm)	L (mm)	B (mm)	C (mm)	D (mm)
S058101	6x100	6	100	210	35	7	12
S058102	6x150	6	150	260	35	7.5	1.2
S058103	8x150	8	150	270	35	8	1.5
S058104	8x200	8	200	320	35	8.5	1.5
S058105	8x250	8	250	370	35	8.5	1.5

6合1迷你棘轮铝合金手柄螺丝刀

6-in-1 Aluminum Screwdriver Set

- 刀头采用S2优质钢材，经久耐用
- 刀杆表面镀铬，抗锈性好
- 铝合金手柄表面电镀，镶嵌橡胶，握持舒适
- 带双向棘轮，使用更省力快捷
- S2 bits for durability
- Chrome plated shaft for rust-resistant
- Anodized aluminum handle with rubber enmeshed
- 3 position high torque ratchet

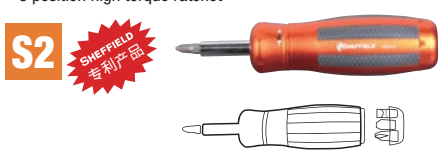

Item no.		
S056504		6
可换旋具头		
十字 / Phillips: #1, #2, #3		
一字 / Slotted: 4, 5, 6mm		

棘轮可换向铝合金手柄螺丝刀

Aluminum Screwdriver

- 批杆表面镀铬，抗锈性好
- 重型铝合金手柄表面电镀，镶嵌橡胶，握持舒适
- 棘轮头可以转向，以0度，45度，90度角操作
- Chrome plated shaft for rust-resistant
- Heavy duty anodized aluminum handle with rubber enmeshed
- Pivoting ratchet drive for 0, 45 and 90-Degree operation



Item no.	Size(mm)	
S056507	185	6

十字通体螺丝刀

Phillips Screwdriver

- 刀杆采用S2优质钢材，表面镀铬处理
- 刀头发黑处理，带强磁
- 贯通式刀杆，适于敲击使用
- 手柄符合人体工学设计，握持舒适
- S2 blade, Chrome plated
- Black magnetic tip
- Steel striking cap
- Ergonomic comfort grip handle

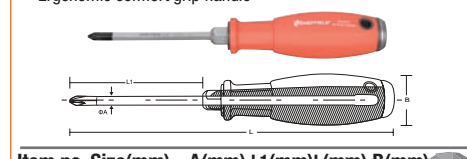

Item no.	Size(mm)	A(mm)	L1(mm)	L(mm)	B(mm)
S058201	PH2x100	6	100	210	35
S058202	PH2x150	6	150	260	35
S058203	PH3x150	6	150	270	35
S058204	PH3x200	8	200	320	35
S058205	PH3x250	8	250	370	35

双头螺丝刀

Screwdriver

- 刀杆采用S2优质钢材，表面镀铬处理
- 刀头发黑处理，带强磁
- 手柄符合人体工程学设计，握持舒适
- 不可敲击
- S2 blade, Chrome plated
- Black magnetic tip
- Ergonomic comfort grip handle
- No knocking

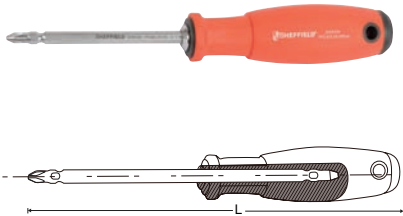

Item no.	Size	L(mm)	
S058305	#1&5mm x 100mm	210	12
S058306	#2&6mm x 100mm	210	12
S058308	#2&6mm x 150mm	260	12

三色柄一字螺丝批

Slotted Screwdriver

- 刀杆采用S2优质钢材，更大扭力，雾化镀铬处理表面，美观耐磨
- 人体工学设计，专利型大三角手柄，超强扭矩，握持舒适，减少工作疲劳，提高效率
- 尾端特有颜色型号标识，方便工作时识别
- S2 blade, Chrome plated
- Ergonomical Triangle shape handle for higher torque
- Handle markings include screw symbol and size of tip to easily find the right screwdriver

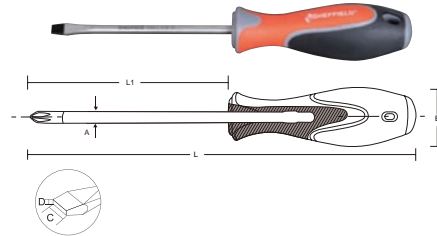

Item no.	Size	A	L1	L	B	C	D	
(mm) (mm) (mm) (mm) (mm) (mm) (mm)								
S059011	3X75	3	75	165	28	0.8	3	12
S059012	3X100	3	100	190	28	0.8	3	12
S059013	5X75	5	75	175	32	1	5.2	12
S059014	5X100	5	100	200	32	1	5.2	12
S059015	5X150	5	150	250	32	1	5.2	12
S059016	6X100	6	100	210	35	1.2	6.2	12
S059017	6X150	6	150	260	35	1.2	6.2	12
S059018	6X200	6	200	310	35	1.2	6.2	12
S059019	8X150	8	150	270	37	1.8	8	12
S059020	8X200	8	200	320	37	1.8	8	12

18件套冲击螺丝批组套

18Pc Impact Screwdriver Set

- 冲击手柄采用优质合金钢，整体锻造加工，坚固耐用
- 配置S2合金钢材质旋具头，表面镀铬处理，防锈耐磨
- Handle drop-forged with high quality Alloy steel, durable performance
- combined with screwdriver bits, S2 alloy steel, Nickel plated, anti-rust and grinding



Item no.	
S058401	6

2件 冲击手柄，8mm系列旋具接头
4件 8mm系列70mm长旋具头8mm, 10mm, PH2, PH3
13件 8mm系列30mm长旋具头5.5mm, 6.5mm, 8mm, 10mm, 12mm, PH1, PH2, PH3, PH4, H5, H6, H8, H10

三色柄十字螺丝批

Phillips Screwdriver

- 刀杆采用S2优质钢材，更大扭力，雾化镀铬处理表面，美观耐磨
- 人体工学设计，专利型大三角手柄，超强扭矩，握持舒适，减少工作疲劳，提高效率
- 尾端特有颜色型号标识，方便工作时识别
- S2 blade, chrome plated
- Ergonomical Triangle shape handle for higher torque power
- Handle markings include screw symbol and size of tip to easily find the right screwdriver



Item no.	Size(mm)	A(mm)	L1(mm)	L(mm)	B(mm)	
S059001	PH0X75	3	75	165	28	12
S059002	PH0X100	3	100	190	28	12
S059003	PH1X75	5	75	175	32	12
S059004	PH1X100	5	100	200	32	12
S059005	PH1X150	5	150	250	32	12
S059006	PH2X100	6	100	210	35	12
S059007	PH2X150	6	150	260	35	12
S059008	PH2X200	6	200	310	35	12
S059009	PH3X150	8	150	270	37	12
S059010	PH3X200	8	200	320	37	12

43件套8mm系列旋具组套

43pc 5/16" Dr.Bits Set

- 高级S2合金钢材质制造，超强硬度扭力
- 表面镀铬处理，耐用
- S2 alloy steel, to support high hardness & torque
- Nickel plated finished



Item no.	
S054001	1

7件 8mm系列30mm长花型旋具头：T20, T25, T30, T40, T45, T50, T55
8件 8mm系列30mm长六角旋具头：H4, H5, H6, H7, H8, H10, H12, H14
5件 8mm系列30mm长十二角旋具头：M5, M6, M8, M10, M12
8件 8mm系列70mm长花型旋具头：T20, T25, T27, T30, T40, T45, T50, T55
8件 8mm系列70mm长六角旋具头：H4, H5, H6, H7, H8, H10, H12, H14
5件 8mm系列70mm长十二角旋具头：M5, M6, M8, M10, M12
1件 12.5mm系列旋具头接头5/16"
1件 10mm系列旋具头接头5/16"

32件套6.3mm系列气动旋具头组套

32PC Color Bits Set

- S2彩圈批头，无磁，强度高
- ABS+透明PC盖塑盒，收纳方便
- S2 steel coloring bits with sanded, no magnetic
- ABS+PC box, easy picking



Item no.	
S054002	1

3件十字：PH#1, #2, #3
3件米字：PZ#1, #2, #3
3件一字：4, 5, 6
6件六角：3, 4, 5, 6, 7, 8
6件中孔花型：TT10, TT15, TT20, TT25, TT30, TT40
1件：6.3mm转换接头
1件：65mm 磁性气动旋具头接杆
3件四角：S1, S2, S3
3件三角：1, 2, 3
3件U型旋具头4, 6, 8

内六角扳手、拉铆枪、硅胶枪、螺丝刀系列、旋具头

5件套6.3mm系列25mm长一字旋具头

1/4"DR. 25mm Slotted Bits

- 高级S2合金钢材质制造，超强硬度扭力
- 表面镀镍处理，耐用
- S2 alloy steel, to support high hardness & torque
- Nickel plated finished



Item no.	Size	Item no.	Size
S053005	3mm	S053008	5.5mm
S053006	4mm	S053009	6mm
S053007	5mm	S053010	6.5mm

5件套6.3mm系列25mm长六角旋具头

1/4"DR. 25mm Hex Bits

- 高级S2合金钢材质制造，超强硬度扭力
- 表面镀镍处理，耐用
- S2 alloy steel, to support high hardness & torque
- Nickel plated finished



Item no.	Size	Item no.	Size
S053014	2mm	S053017	4mm
S053015	2.5mm	S053018	5mm
S053016	3mm	S053019	6mm
S053017	4mm	S053020	7mm
S053018	5mm	S053021	8mm

5件套6.3mm系列50mm长一字旋具头

1/4"DR. 50mm Slotted Bits

- 高级S2合金钢材质制造，超强硬度扭力
- 表面镀镍处理，耐用
- S2 alloy steel, to support high hardness & torque
- Nickel plated finished



Item no.	Size	Item no.	Size
S053103	3mm	S053104	4mm
S053104	4mm	S053105	5mm
S053105	5mm	S053106	6mm

5件套6.3mm系列25mm长十字旋具头

1/4"DR. 25mm Phillips Bits

- 高级S2合金钢材质制造，超强硬度扭力
- 表面镀镍处理，耐用
- S2 alloy steel, to support high hardness & torque
- Nickel plated finished



Item no.	Size	Item no.	Size
S053001	PH0	S053002	PH1
S053002	PH1	S053003	PH2
S053003	PH2	S053004	PH3

5件套6.3mm系列25mm长花型旋具头

1/4"DR. 25mm Torx Bits

- 高级S2合金钢材质制造，超强硬度扭力
- 表面镀镍处理，耐用
- S2 alloy steel, to support high hardness & torque
- Nickel plated finished



Item no.	Size	Item no.	Size
S053022	T8	S053025	T20
S053023	T10	S053026	T25
S053024	T15	S053027	T27
S053025	T20	S053028	T30
S053026	T25	S053029	T40

5件套8mm系列30mm长十二角旋具头

5/16"DR. 30mm 12pt Bits

- 高级S2合金钢材质制造，超强硬度扭力
- 表面镀镍处理，耐用
- S2 alloy steel, to support high hardness & torque
- Nickel plated finished



Item no.	Size	Item no.	Size
S053244	M5	S053246	M8
S053245	M6	S053247	M10
S053246	M8	S053248	M12

5件套6.3mm系列25mm长米字旋具头

1/4"DR. 25mm Pozi Bits

- 高级S2合金钢材质制造，超强硬度扭力
- 表面镀镍处理，耐用
- S2 alloy steel, to support high hardness & torque
- Nickel plated finished



Item no.	Size	Item no.	Size
S053011	PZ1	S053012	PZ2
S053012	PZ2	S053013	PZ3

5件套6.3mm系列25mm长中孔花型旋具头

1/4"DR. 25mm Tamper Resistant Torx Bits

- 高级S2合金钢材质制造，超强硬度扭力
- 表面镀镍处理，耐用
- S2 alloy steel, to support high hardness & torque
- Nickel plated finished



Item no.	Size	Item no.	Size
S053030	T8	S053033	T20
S053031	T10	S053034	T25
S053032	T15	S053035	T27
S053033	T20	S053036	T30
S053034	T25	S053037	T40

5件套6.3mm系列接杆

1/4"DR. Bits Holder

- 高级S2合金钢材质制造，超强硬度扭力
- 表面镀镍处理，耐用
- S2 alloy steel, to support high hardness & torque
- Nickel plated finished



Item no.	Size	Item no.	Size
S053401	25mm	S053402	50mm

5件套6.3mm系列接杆

1/4"DR. Bits Magnetic Holder

- CR-V材质制造，头部强磁处理
- CR-V alloy steel, magnetic tip



Item no.	Size	Item no.	Size
S053403	60mm		

5件套6.3mm系列110mm长双头旋具头

1/4"DR. 110mm Double End Bits

- 高级S2合金钢材质制造, 超强硬度扭力
- 表面镀镍处理, 耐用
- S2 alloy steel, to support high hardness & torque
- Nickel plated finished



Item no.	Size	
S056169	PH2-PH2	12

5件套6.3mm系列65mm长双头旋具头

1/4"DR. 65mm Double End Bits

- 高级S2合金钢材质制造, 超强硬度扭力
- 表面镀镍处理, 耐用
- S2 alloy steel, to support high hardness & torque
- Nickel plated finished



Item no.	Size	
S053136	PH1-PH1	12
S053137	PH2-PH2	12
S053138	PH3-PH3	12
S053155	5.5mm-PH2	12
S056166	PH1-PH2	12

5件套8mm系列30mm长米字旋具头

5/16"DR. 30mm Pozi Bits

- 高级S2合金钢材质制造, 超强硬度扭力
- 表面镀镍处理, 耐用
- S2 alloy steel, to support high hardness & torque
- Nickel plated finished



Item no.	Size	
S053240	PZ1	12
S053241	PZ2	12
S053242	PZ3	12
S053243	PZ4	12

5件套6.3mm系列50mm长十字旋具头

1/4"DR. 50mm Phillips Bits

- 高级S2合金钢材质制造, 超强硬度扭力
- 表面镀镍处理, 耐用
- S2 alloy steel, to support high hardness & torque
- Nickel plated finished



Item no.	Size	
S053110	PH0	12
S053111	PH1	12
S053112	PH2	12

5件套6.3mm系列50mm长六角旋具头

1/4"DR. 50mm Hex Bits

- 高级S2合金钢材质制造, 超强硬度扭力
- 表面镀镍处理, 耐用
- S2 alloy steel, to support high hardness & torque
- Nickel plated finished



Item no.	Size	
S053132	3mm	12
S053133	4mm	12
S053134	5mm	12
S053135	6mm	12

5件套6.3mm系列50mm长花型旋具头

1/4"DR. 50mm Torx Bits

- 高级S2合金钢材质制造, 超强硬度扭力
- 表面镀镍处理, 耐用
- S2 alloy steel, to support high hardness & torque
- Nickel plated finished



Item no.	Size	
S053115	T10	12
S053116	T15	12
S053117	T20	12
S053118	T25	12

5件套8mm系列30mm长一字旋具头

5/16"DR. 30mm Slotted Bits

- 高级S2合金钢材质制造, 超强硬度扭力
- 表面镀镍处理, 耐用
- S2 alloy steel, to support high hardness & torque
- Nickel plated finished



Item no.	Size	
S053205	5.5mm	12
S053206	6.5mm	12
S053207	8mm	12
S053208	10mm	12
S053209	12mm	12

5件套8mm系列30mm长十字旋具头

5/16"DR. 30mm Phillips Bits

- 高级S2合金钢材质制造, 超强硬度扭力
- 表面镀镍处理, 耐用
- S2 alloy steel, to support high hardness & torque
- Nickel plated finished



Item no.	Size	
S053201	PH1	12
S053202	PH2	12
S053203	PH3	12
S053204	PH4	12

5件套8mm系列30mm长六角旋具头

5/16"DR. 30mm Hex Bits

- 高级S2合金钢材质制造, 超强硬度扭力
- 表面镀镍处理, 耐用
- S2 alloy steel, to support high hardness & torque
- Nickel plated finished



Item no.	Size		Item no.	Size	
S053210	4mm	12	S053215	10mm	12
S053211	5mm	12	S053216	12mm	12
S053212	6mm	12	S053217	14mm	12
S053214	8mm	12			

5件套8mm系列30mm长花型旋具头

5/16"DR. 30mm Torx Bits

- 高级S2合金钢材质制造, 超强硬度扭力
- 表面镀镍处理, 耐用
- S2 alloy steel, to support high hardness & torque
- Nickel plated finished



Item no.	Size		Item no.	Size	
S053220	T20	12	S053225	T45	12
S053221	T25	12	S053226	T50	12
S053223	T30	12	S053227	T55	12
S053224	T40	12			





切割类工具 **CUTTING TOOLS**

断线钳、各式割刀、剪刀、锯类
Bolt Cutter, Knife, Snip, Saw

迷你断线钳

Mini Bolt Cutter

- 钳头采用铬钒钢锻造而成
- 刃口硬度控制在58-60HRC, 使用寿命更长
- 优质橡塑手柄, 结实牢固, 握持舒适
- Drop forged CR-V steel jaws
- Jaws hardened to HRC 58-60 for longer life
- Strong tubular handles with rubber grips

! 请勿用来剪切硬度超过HRC40的中碳钢或高碳钢
Not used to cut medium and high carbon steels which hardness are over HRC 40

CR-V



Item no.	Size	L(mm)	Soft materials	Medium materials	
S066008	8"	203	3.17mm	3.17mm	6

9mm不锈钢美工刀

9mm Snap Off Knife

- 刀片采用SK5优质材料, 锋利耐用
- 刀壳采用不锈钢, 结实耐用
- 尾部盖子可用于折断刀片, 安全方便
- Razor-Sharp tempered SK5 blade
- Stainless steel housing
- Safety cap used to snap off blades



Item no.	Size	L(mm)	
S067002	9mm	130	12

18mm塑柄金属护套旋钮美工刀

18mm Auto Reload Snap Knife

- 刀片采用SK5优质材料, 锋利耐用
- 不锈钢护鞘, 坚固安全
- 刀壳采用工程塑料ABS注塑而成, 结实耐用
- 旋钮紧固刀片, 适用于精确切割作业
- 手柄符合人体工程学设计, 握持舒适
- Razor-Sharp tempered SK5 blade
- Stainless steel flute for strength and rust resistance
- High-impact ABS housing
- Thumb-screw dial lock blade for safety
- Ergonomic comfort grip handle



Item no.	Size	L(mm)	
S067011	18mm	164	12

断线钳

Bolt Cutter

- 钳头采用铬钼钢锻造而成
- 刃口硬度控制在58-60HRC, 使用寿命更长
- 适合剪切螺栓、铁棍、铆钉、铁链等
- 钢管胶柄, 结实牢固, 握持舒适
- 符合美国GGG-C-740d标准
- Drop forged chrome molybdenum steel jaws
- Jaws hardened to HRC 58-60 for longer life
- Ideal for cutting bolts, rods, rivets, and chain
- Strong tubular handles with rubber grips
- Exceeds USA specification GGG-C-740d

! 请勿用来剪切硬度超过HRC40的中碳钢或高碳钢
Not used to cut medium and high carbon steels which hardness are over HRC 40

CR-MO



Item no.	Size	L(mm)	Soft materials	Medium materials	
S066012	12"	305	5mm	4mm	6
S066014	14"	355	7mm	5mm	6
S066018	18"	457	8mm	6mm	2
S066024	24"	609	10mm	8mm	2
S066030	30"	762	13mm	10mm	1
S066036	36"	914	16mm	12mm	1

重型锌合金美工刀

Heavy Duty Cutting Knife

- 采用优质锌合金材质, 结实耐用
- 不锈钢刀套, 坚固安全
- 刀片采用SK5材质, 锋利耐用
- High quality with zinc alloy material, durable performance
- Stainless sheath, better quality with safety
- SK5 for blade, more sharp and durable



Item no.	Size	L(mm)	
S067007	9mm	130	12
S067008	18mm	172	12

塑柄金属护套美工刀

Auto Reload Snap Knife

- 刀片采用SK5优质材料, 锋利耐用
- 不锈钢护鞘, 坚固安全
- 刀壳采用工程塑料ABS注塑而成, 结实耐用
- 刀片自动锁定, 操作更安全
- 手柄符合人体工程学设计, 握持舒适
- Razor-Sharp tempered SK5 blade
- Stainless steel flute for strength and rust resistance
- High-impact ABS housing
- Positive blade auto lock
- Ergonomic comfort grip handle



Item no.	Size	L(mm)	
S067013	9mm	128	12
S067014	18mm	164	12

9mm塑柄美工刀

9mm Snap Off Knife

- 刀片采用SK5优质材料, 锋利耐用
- 刀片可以分段使用, 延长寿命
- 刀壳采用工程塑料ABS注塑而成, 结实耐用
- Razor-Sharp tempered SK5 blade
- Snap off used blades for a new cutting edge
- High-impact ABS housing



Item no.	Size	L(mm)	
S067005	9mm	128	12

9mm高级快换刀片型美工刀

9mm Snap Off Knife

- 刀片采用SK5优质材料, 锋利耐用
- 不锈钢护鞘, 坚固安全
- 刀壳采用工程塑料ABS注塑而成, 结实耐用
- 刀片自动锁定, 操作更安全
- 手柄符合人体工程学设计, 握持舒适
- Razor-Sharp tempered SK5 blade
- Stainless steel flute for strength and rust resistance
- High-impact ABS housing
- Positive blade auto lock
- Ergonomic comfort grip handle



Item no.	Size	L(mm)	
S067004	9mm	135	12

18mm高级快换刀片型美工刀

18mm Auto Reload Snap Knife

- 刀片采用SK5优质材料, 锋利耐用
- 不锈钢护鞘, 坚固安全
- 刀壳采用工程塑料ABS注塑而成, 结实耐用
- 刀片自动锁定, 操作更安全
- 手柄符合人体工程学设计, 握持舒适
- 内置5片刀片
- Razor-Sharp tempered SK5 blade
- Stainless steel flute for strength and rust resistance
- High-impact ABS housing
- Positive blade auto lock
- Ergonomic comfort grip handle
- 5 blades stored in handle



Item no.	Size	L(mm)	
S067015	18mm	170	12



美工刀替换刀片

Snap Off Spare Blade

- 刀片采用SK5优质材料，锋利耐用
- 适用各种9mm系列的美工刀
- Razor-Sharp tempered SK5 blade
- Universal fit for all 9mm snap-off knives



Item no.	Size	Thickness	Num(pc)	
S067109	9mm	0.4mm	10	12

锌合金割刀

Utility Knife

- 刀片采用SK5优质材料，锋利耐用
- 锌合金刀体，牢固耐用
- Razor-Sharp tempered SK5 blade
- Zinc-alloy housing



Item no.	Size	L(mm)	
S067211	18mm	152	12

美工刀替换刀片

Snap Off Spare Blade

- 刀片采用SK5优质材料，锋利耐用
- 适用各种18mm系列的美工刀
- Razor-Sharp tempered SK5 blade
- Universal fit for all 18mm snap-off knives



Item no.	Size	Thickness	Num(pc)	
S067118	18mm	0.5mm	10	12

自缩式安全割刀

Self-Retracting Knife

- 刀片采用SK5优质材料，锋利耐用
- 锌合金刀体，牢固耐用
- 不在使用状态时，刀片自动缩回，提高安全性
- Razor-Sharp tempered SK5 blade
- Zinc-alloy housing
- Spring-loaded blade retracts automatically when not in use



Item no.	Size	L(mm)	
S067201	18mm	148	12

自缩式纸箱专用安全割刀

Self-Retracting Knife

- 刀片采用SK5优质材料，锋利耐用
- 锌合金刀体，牢固耐用
- 不在使用状态时，刀片自动缩回，提高安全性
- Razor-Sharp tempered SK5 blade
- Zinc-alloy housing
- Spring-loaded blade retracts automatically when not in use



Item no.	Size	L(mm)	
S067202	18mm	149	12

胶柄锌合金割刀

Utility Knife

- 刀片采用SK5优质材料，锋利耐用
- 锌合金刀体，牢固耐用
- 橡胶手柄，握持舒适
- Razor-Sharp tempered SK5 blade
- Zinc-alloy housing
- Comfort grip handle



Item no.	Size	L(mm)	
S067212	18mm	151	12

固定式重型专业割刀

Heavy Duty Utility Knife

- 刀片采用SK5优质材料，锋利耐用
- 锌合金刀体，牢固耐用
- Razor-Sharp tempered SK5 blade
- Zinc-alloy housing



Item no.	Size	L(mm)	
S067210	18mm	135	12

重型锌合金割刀

Heavy Duty Utility Knife

- 刀片采用SK5优质材料，锋利耐用
- 重型锌合金刀体，牢固耐用
- Razor-Sharp tempered SK5 blade
- Heavy duty zinc-alloy housing



Item no.	Size	L(mm)	
S067213	18mm	151	12

快换式专业重型割刀 Quick Change Heavy Duty Utility Knife

- 刀片采用SK5优质材料，锋利耐用
- 独特专利设计，快速安全更换刀片
- 重型锌合金刀体，牢固耐用
- 使用标准实用刀片



- Precision die cast zinc body
- Ergonomically designed handle
- "No tools" blade change is fast and easy with just a push of the button
- Blade locks in 4 positions
- 3 Blades stored in handle



独特专利设计结构，快速更换刀片。
Push button to quick open blade storage and easy to change blade



锌合金推钮，舒适耐用。
Push button to load or retract blade

Item no.	Size	L(mm)	
S067214	18mm	150	12

不锈钢多功能刀

14-in-1 Multi-Function Tool

- 采用优质不锈钢制造
- 可以折叠, 携带方便
- Stainless steel
- Foldable, easy to carry



Item no.	
S067215	12
螺丝锥, 勾, 锥子, 开罐器, 开瓶器, 一字螺丝刀, 小型一字螺丝刀, 刀, 小刀, 剪刀, 钥匙环	
Corkscrew, hook, awl, can opener, bottle opener, slotted screwdriver, small slotted screwdriver, knife, small knife, scissors, key chain ring	

铝合金折叠割刀

Quick Change Folding Lock-Back Utility Knife

- 刀片采用SK5优质材料, 锋利耐用
- 独特专利设计, 快速安全更换刀片
- 可折叠, 方便携带
- 附带皮带扣功能
- 使用标准实用刀片
- Razor-Sharp tempered SK5 blade
- Patented quick-change mechanism
- Easily folds to a compact size to fit in pocket
- Includes belt clip for easy access
- Accepts all standard utility blades



Item no.	L(mm)	
S067218	92	12

双色柄可储刀片式折叠刀

Quick Change Folding Lock-Back Utility Knife

- 刀片采用SK5优质材料, 锋利耐用
- 独特专利设计, 快速安全更换刀片
- 手柄带刀片存储装置
- 可折叠, 方便携带
- 附带皮带扣功能
- 使用标准实用刀片
- Razor-Sharp tempered SK5 blade
- Patented quick-change mechanism
- Blade storage in handle
- Easily folds to a Compact Size to fit in pocket
- Includes belt clip for easy access
- Accepts all standard utility blades



Item no.	L(mm)	
S067220	100	12

迷你型彩木不锈钢折叠刀

Mini Quick Change Folding Lock-Back Utility Knife

- 刀片采用SK5优质材料, 锋利耐用
- 独特专利设计, 快速安全更换刀片
- 彩木手柄, 美观大方
- 可折叠, 方便携带
- Razor-Sharp tempered SK5 blade
- Patented quick-change mechanism
- Handsome wood grain handle
- Easily folds to a compact size to fit in pocket



Item no.	L(mm)	
S067216	65	12

不锈钢折叠刀

Quick Change Folding Lock-Back Utility Knife

- 刀片采用SK5优质材料, 锋利耐用
- 独特专利设计, 快速安全更换刀片
- 不锈钢刀壳, 美观牢固
- 可折叠, 方便携带
- 附带皮带扣功能
- 使用标准实用刀片
- Razor-Sharp tempered SK5 blade
- Patented quick-change mechanism
- Stainless steel housing
- Easily folds to a Compact Size to fit in pocket
- Includes belt clip for easy access
- Accepts all standard utility blades



Item no.	L(mm)	
S067219	105	12

重型割刀刀片

Heavy Duty Utility Blade

- 刀片采用SK5优质材料, 锋利耐用
- 适用于各种切割作业
- 适用于固定式实用刀
- 内装100片刀片
- Razor-Sharp tempered SK5 blade
- Ideal for cutting thick, dense sheet materials
- Designed for fixed blade knives only
- Includes 100 blades



Item no.	Thickness	Num(pc)	
S067301	0.6mm	100	12

彩木不锈钢折叠刀

Quick change Folding Lock-Back Utility Knife

- 刀片采用SK5优质材料, 锋利耐用
- 独特专利设计, 快速安全更换刀片
- 彩木手柄, 美观大方
- 可折叠, 方便携带
- 附带皮带扣功能
- 使用标准实用刀片
- Razor-Sharp tempered SK5 blade
- Patented quick-change mechanism
- Handsome wood grain handle
- Easily folds to a compact size to fit in pocket
- Includes belt clip for easy access
- Accepts all standard utility blades



Item no.	L(mm)	
S067217	93	12

不锈钢单开刀

One-handed Operation Knife

- 刀片采用不锈钢, 锋利耐用
- 铝合金手柄
- 可折叠, 方便携带
- 附带皮带扣功能
- Razor-Sharp tempered stainless steel blade
- Aluminum handle
- Easily folds to a compact size to fit in pocket
- Includes belt clip for easy access



Item no.	L(mm)	
S067221	105	12

重型割刀刀片

Heavy Duty Utility Blade

- 刀片采用SK5优质材料, 锋利耐用
- 适用于各种切割作业
- 适用于固定式实用刀
- 内装10片刀片
- Razor-Sharp tempered SK5 blade
- Ideal for cutting thick, dense sheet materials
- Designed for fixed blade knives only
- Includes 10 blades



Item no.	Thickness	Num(pc)	
S067302	0.6mm	10	12
S067304	0.44mm	10	12

断线钳、各式割刀、剪刀、锯类

安全割刀刀片

Utility Blade

- 刀片采用SK5优质材料，锋利耐用
- 适用于各种切割作业
- 适用于固定式实用刀
- 内装10片刀片

- Razor-Sharp tempered SK5 blade
- Ideal for cutting thick, dense sheet materials
- Designed for fixed blade knives only
- Includes 10 blades



Item no.	Thickness	Num(pc)	
S067303	0.6mm	10	12

带孔安全割刀刀片

Regular Duty Utility Blade

- 刀片采用SK5优质材料，锋利耐用
- 适用于各种切割作业
- 适用于固定式实用刀
- 内装10片刀片

- Razor-Sharp tempered SK5 blade
- Ideal for cutting thick, dense sheet materials
- Designed for fixed blade knives only
- Includes 10 blades



Item no.	Thickness	Num(pc)	
S067306	0.6mm	10	12

勾型割刀刀片

Regular Duty Utility Blade

- 刀片采用SK5优质材料，锋利耐用
- 勾型刀片，适用于切割地毯、皮革等材料
- 适用于多数标准实用刀
- 内装10片刀片

- Razor-sharp tempered SK5 blade
- Blades have deeper hook for cutting thicker
- Fits most standard utility knives
- Includes 10 blades



Item no.	Thickness	Num(pc)	
S067307	0.6mm	10	12

10" 航空剪 (右弯头)

10" Right Cut Aviation Tin Snip

- 铬钒钢钳头，剪切能力强，最大可剪切1.2mm冷轧板或0.7mm不锈钢板
- 刃口带锯齿设计，剪切时可防止材料滑动
- 手柄握持舒适，符合人体工程学设计
- 符合美国ANSI B107.16M标准

- Chrome-Vanadium steel
- Serrated cutting edges prevent materials from slipping during use
- Ergonomic comfort grip handle
- Meets or exceeds ANSI B107.16M standard

CR-V



Item no.	Size	L(mm)	
S068101	10"	254	6

10" 航空剪 (直头)

10" Straight Aviation Tin Snip

- 铬钒钢钳头，剪切能力强，最大可剪切1.2mm冷轧板或0.7mm不锈钢板
- 刃口带锯齿设计，剪切时可防止材料滑动
- 手柄握持舒适，符合人体工程学设计
- 符合美国ANSI B107.16M标准

- Chrome-Vanadium steel
- Serrated cutting edges prevent materials from slipping during use
- Ergonomic comfort grip handle
- Meets or exceeds ANSI B107.16M standard.

CR-V



Item no.	Size	L(mm)	
S068102	10"	254	6

10" 航空剪 (左弯头)

10" Left Cut Aviation Tin Snip

- 铬钒钢钳头，剪切能力强，最大可剪切1.2mm冷轧板或0.7mm不锈钢板
- 刃口带锯齿设计，剪切时可防止材料滑动
- 手柄握持舒适，符合人体工程学设计
- 符合美国ANSI B107.16M标准

- Chrome-Vanadium steel
- Serrated cutting edges prevent materials from slipping during use
- Ergonomic comfort grip handle
- Meets or exceeds ANSI B107.16M standard.

CR-V



Item no.	Size	L(mm)	
S068103	10"	254	6

长直头航空剪

Long Straight Aviation Snip

- 铬钒钢钳头，剪切能力强，最大可剪切1.2mm冷轧板或0.7mm不锈钢板
- 刃口带锯齿设计，剪切时可防止材料滑动
- 手柄握持舒适，符合人体工程学设计
- 符合美国ANSI B107.16M标准

- Chrome-Vanadium steel
- Serrated cutting edges prevent materials from slipping during use
- Ergonomic comfort grip handle
- Meets or exceeds ANSI B107.16M standard

CR-V



Item no.	Size	L(mm)	
S068104	10"	254	6

双色不锈钢剪刀

Stainless Steel Scissors

- 刀片采用优质不锈钢材料，精制加工而成
- 刃口特殊工艺加工，硬度均匀，剪切锋利
- 双色手柄，美观大方，握感舒适省力
- Precision-ground stainless steel blades
- Hardened and tempered blades for superior cutting power
- Comfort grip handles reduce fatigue



Item no.	Size	L(mm)	
S068001	6-1/2"	165	12
S068002	8-1/4"	210	12

铁皮剪

Tin Snip

- 采用优质合金钢锻造
- 剪切能力强
- 带大环手柄，操作方便
- 双沾塑手柄，握持舒适
- Drop forged steel
- Precision ground blades
- Large handle loops
- Double dipped grip handle



Item no.	Size	Capacity(mm) (冷轧板/不锈钢板)	L(mm)	
S068207	7"	0.45/0.38	178	10
S068210	10"	0.78/0.45	254	6
S068212	12"	0.91/0.63	305	6

英式铁皮剪

Tin Snip

- 采用优质合金钢锻造
- 剪切能力强
- 双沾塑手柄，握持舒适
- Drop forged steel
- Precision ground blades
- Double dipped grip handle



Item no.	Size	Capacity(mm) (冷轧板/不锈钢板)	L(mm)	
S068308	8"	0.61/0.41	205	6
S068310	10"	0.78/0.45	255	6
S068312	12"	0.91/0.63	305	6
S068314	14"	1.2/0.7	355	6

袖珍钢锯

Mini Hacksaw

- 锯架采用工程塑料ABS，坚固耐用
- 手柄符合人体工程学
- 使用250mm或者300mm锯条
- High-impact ABS frame
- Ergonomically designed grip
- 10" or 12" saw blade



Item no.	L(mm)	Blade size	
S069001	267	10"	6

迷你钢锯

6" Mini Hacksaw

- 铝合金锯架，坚固耐用
- 手柄符合人体工程学
- 使用150mm锯条
- Aluminum alloy frame
- Ergonomically designed grip
- 6" Saw blade



Item no.	L(mm)	Blade size	
S069002	255	6"	6

钢锯

12" High Tension Hacksaw

- 金属锯架，坚固耐用
- 锯弓张力可调，适应各种切割状况
- 快速更换锯条结构设计
- 手柄符合人体工程学
- 使用300mm锯条
- Metal frame
- Adjustable tension
- Quick-release, blade changing mechanism
- Ergonomically designed grip
- 12" Saw blade

升级



Item no.	L(mm)	Blade size	
S069003	465	12"	6

铝合金方管钢锯

12" High Tension Hacksaw

- 铝合金方管锯架，坚固耐用
- 锯弓张力可调，适应各种切割状况
- 快速更换锯条结构设计
- 手柄符合人体工程学
- 使用300mm锯条
- Aluminum alloy frame
- Adjustable tension
- Quick-release, blade changing mechanism
- Ergonomically designed grip
- 12" Saw blade

升级



Item no.	L(mm)	Blade size	
S069004	400	12"	6

ABS人体工学手柄钢锯

12" High Tension Hacksaw

- 铝合金方管锯架，ABS手柄，坚固耐用
- 锯弓张力可调，适应各种切割状况
- 快速更换锯条结构设计
- 手柄符合人体工程学
- 使用300mm锯条
- Aluminum alloy frame
- Adjustable tension
- Quick-release, blade changing mechanism
- Ergonomically designed grip
- 12" Saw blade

SHEFFIELD 专利产品



Item no.	L(mm)	Blade size	
S069005	415	12"	6

可翻式铝合金钢锯

12" High Tension Hacksaw

- 铝合金方管锯架，ABS手柄，坚固耐用
- 锯弓张力可调，可翻转适应各种切割状况
- 快速更换锯条结构设计
- 手柄符合人体工程学
- 使用300mm锯条
- Aluminum alloy frame
- Adjustable tension
- Quick-release, blade changing mechanism
- Ergonomically designed grip
- 12" Saw blade



锯架可翻转

Item no.	L(mm)	Blade size	
S069006	410	12"	6

3PC迷你型钢锯条

3PC 6" Hacksaw Blade

- 锯条采用优质钢材
- 防锈润滑涂层，使切割更流畅
- 配合迷你锯（S069002）使用
- 6" 18 TPI blade
- Anti-stick coating for easier cuts and reduced friction
- Use with mini hacksaw (S069002)



Item no.	Size	Num.(pc)	
S069106	6"	3	12

双金属钢锯条

Hacksaw Blade

- 齿口采用优质高速钢，齿身采用优质弹簧钢
- 防锈润滑涂层，使切割更流畅
- 12" Bi-metal 18TPI, 24TPI, 32TPI blade
- Anti-stick coating for easier cuts and reduced friction



Item no.	Size	Num.(pc)	
S069118	12" (18TPI)	100	1
S069124	12" (24TPI)	100	1
S069132	12" (32TPI)	100	1

2PC 24齿双金属锯条

2PC 24 gear double metal saw blade

- 齿口采用优质高速钢，齿身采用优质弹簧钢
- 防锈润滑涂层，使切割更流畅
- Tooth mouth using high-quality high-speed steel, tooth body with high-quality spring steel
- Anti rust lubricating coating to make cutting smoother

新品



Item no.	Size	
S069134	12"(24TPI)	25

10PC 24齿双金属锯条

10PC 24 gear double metal saw blade

- 齿口采用优质高速钢，齿身采用优质弹簧钢
- 防锈润滑涂层，使切割更流畅
- Tooth mouth using high-quality high-speed steel, tooth body with high-quality spring steel
- Anti rust lubricating coating to make cutting smoother

新品



Item no.	Size	
S069135	12"(24TPI)	25

折叠锯

Folding Pocket Saw

- 锯齿经特殊处理，锋利坚韧
- 手柄符合人体工程学
- 易于携带
- Hardened and tempered steel blade
- Ergonomic non-slip rubber grip handle
- Easy to carry



增加锁紧装置

升级

Item no.	Size	L(mm)	Blade size	
S069201	8" (7TPI)	250	205mm	6

手扳锯

Hand Saw

- 锯齿经特殊处理，锋利坚韧
- 手柄符合人体工程学
- Precision ground teeth
- Ergonomic comfort rubber grip handle



Item no.	Size	L(mm)	
S069216	16" (7TPI)	400	6
S069218	18" (7TPI)	450	6
S069220	20" (7TPI)	500	6



测量类工具 **MEASURING TOOLS**

塞尺、卷尺、水平尺、不锈钢尺、游标卡尺
Feeler Gauge, Tape Measure, Level, Square, Vernier Caliper

13片塞尺 - 公英制

13-Blade Feeler Gauge

- 塞尺宽度：13mm
- Blade Width: 13mm



Item no.

S070013



12

0.05mm, 0.10mm, 0.15mm, 0.20mm, 0.25mm, 0.30mm, 0.40mm, 0.50mm, 0.60mm, 0.70mm, 0.80mm, 0.90mm, 1.00mm

14片塞尺 - 公英制

14-Blade Feeler Gauge

- 塞尺宽度：10mm
- Blade Width: 10mm

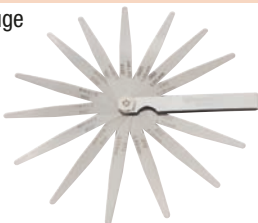

Item no.

S070014



12

0.05mm, 0.06mm, 0.07mm, 0.08mm, 0.09mm, 0.10mm, 0.15mm, 0.20mm, 0.25mm, 0.30mm, 0.40mm, 0.50mm, 0.75mm, 1.00mm

23片塞尺 - 公英制

23-Blade Feeler Gauge

- 塞尺宽度：10mm
- Blade Width: 10mm

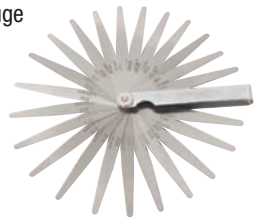

Item no.

S070023



12

0.02mm, 0.04mm, 0.05mm, 0.06mm, 0.07mm, 0.08mm, 0.09mm, 0.10mm, 0.15mm, 0.20mm, 0.25mm, 0.30mm, 0.35mm, 0.40mm, 0.45mm, 0.50mm, 0.55mm, 0.60mm, 0.70mm, 0.80mm, 0.85mm, 0.90mm, 1.00mm

32片塞尺 - 公英制

32-Blade Feeler Gauge

- 塞尺宽度：10mm
- Blade Width: 10mm

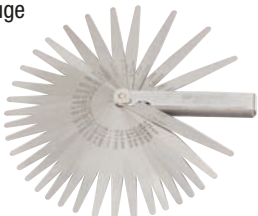

Item no.

S070032



12

0.03mm, 0.04mm, 0.05mm, 0.06mm, 0.07mm, 0.08mm, 0.09mm, 0.10mm, 0.13mm, 0.15mm, 0.18mm, 0.20mm, 0.23mm, 0.25mm, 0.28mm, 0.30mm, 0.33mm, 0.35mm, 0.38mm, 0.40mm, 0.45mm, 0.50mm, 0.55mm, 0.60mm, 0.63mm, 0.65mm, 0.70mm, 0.75mm, 0.80mm, 0.85mm, 0.90mm, 1.00mm

卷尺

Tape Measure

- 尺壳采用ABS材料，抗冲击
- 强力弹簧保证尺带平滑伸缩
- 带有强力皮带扣
- High-impact ABS case
- Heat-treated spring provides long life and smooth blade rewind
- Strong belt clip



Item no.

Size

Blade width



S077002

2m

16mm

12

S077003

3m

16mm

12

S077005

5m

19mm

12

S077075

7.5m

25mm

12

橡塑卷尺

Tape Measure

- 尺带采用高级钢材，表面尼龙涂层，更耐磨
- 尺壳采用TPR + ABS材料，防滑抗冲击
- 强力弹簧保证尺带平滑伸缩
- 带有强力皮带扣
- Nylon coated blade for maximum durability
- Impact resistant rubberized case
- Heat-treated spring provides long life and smooth blade rewind
- Strong belt clip



Item no.

Size

Blade width



S077135

3.5m

16mm

12

S077105

5m

19mm

12

S077155

5.5m

19mm

12

S077175

7.5m

25mm

12

强力型卷尺

Tape Measure

- 尺带采用高级钢材，表面尼龙涂层，更耐磨
- 尺壳采用强力ABS材料，防滑抗冲击
- 强力弹簧保证尺带平滑伸缩
- 带有强力皮带扣
- Nylon coated blade for maximum durability
- Impact resistant rubberized case
- Heat-treated spring provides long life and smooth blade rewind
- Strong belt clip



Item no.

Size

Blade width



S077235

3.5m

16mm

12

S077205

5m

19mm

12

S077255

5.5m

19mm

12

S077275

7.5m

25mm

12

长钢卷尺

Long Steel Tape

- 尺带采用优质钢材，高精度印刷，耐磨损
- ABS尺壳，强度高，抗冲击
- 可折叠手柄，快速回收尺带
- High Carbon steel blade, easy to read, long life
- Shock resistant with closed ABS case
- Folding handle for quick rewind tape

新品



Item no.

Size

Blade width



S077520

20M

10mm

1

S077530

30m

10mm

1

玻璃纤维卷尺

Fiberglass Measuring Tape

- 尺带采用高级玻璃纤维，刻度清晰易读，耐磨损
- 抗冲击ABS外壳，有效防震
- 可折叠手柄，快速回收尺带
- Fiberglass blade
- Shock resistant with closed ABS case
- Folding handle for quick rewind tape



Item no.

Size

Blade width



S077320

20m

13mm

6

S077330

30m

13mm

6

S077350

50m

13mm

6

架式长卷尺

Open Reel Fiberglass Long Tape Rule

- 尺带采用高级玻璃纤维，刻度清晰易读，耐磨损
- 符合人体工程学的握柄
- 高强度抗冲击手柄
- Fiberglass blade
- Ergonomic comfort grip
- Compact rewind handle

3倍速回缩



Item no.

Size

Blade width



S077430

30m

13mm

6

S077450

50m

13mm

6



铝合金自锁卷尺

Self-locking Tape Measure

- 优质铝合金材质外壳，氧化处理表面，高光切削工艺加工，耐压抗冲击
- 尺带采用高级钢材，表面耐磨尼龙涂层，公英制双刻度
- 自锁结构设计，操作方便
- 强力弹簧保证尺带伸缩自如平滑
- 带有强力皮带扣
- Self-locking Aluminum Tape Measure
- Anodized aluminum housing for durability & strength
- MM & Inch stainless steel blade with nylon coated
- Self-locking blade for easy operation
- With metal clip for easy carrying



Item no.	Size	Blade width	
S077503	3m/10ft	13mm	12
S077505	5m/16ft	19mm	12
S077575	7.5m/25ft	25mm	12

工字式水平尺

Aluminum Box Level

- 铝合金框架
- 两端装有橡胶盖帽，抗震性好
- V型凹槽适于管道作业
- 3个高可见度水泡
- Aluminum frame
- Rubber ends for shock absorption
- V-groove working edge fits on pipe or conduit
- 3 high visible vials



Item no.	Size	L(mm)	Vials	
S078218	18"	450	3	6
S078224	24"	600	3	6
S078240	40"	1000	3	6
S078248	48"	1200	3	6

活动直角尺

Combination Square

- 尺身采用不锈钢制造，经久耐用
- 尺座采用锌合金压铸
- 铜螺丝带弹簧确保精确定位
- 带铜画线器和抗冲击水泡
- Stainless steel blades with black etchings
- Die-cast zinc body
- Brass bolt spring-loaded blade assures firm, accurate settings
- With brass scriber and impact-resistant vial



Item no.	Size	L(mm)	
S079003	12"	300	6

鱼雷式水平尺

9" Torpedo Level

- 采用铝合金拉伸成型工艺
- 采用双材料制造，两端装有橡胶，抗震性好
- 底座磁力强劲
- 高可见度水泡（垂直、水平、45度）
- Aluminum stretch forming process
- Rubber ends for shock absorption
- Strong-holding magnetic base with milled edge
- High visible vials read plumb, level and 45 degrees



Item no.	Size	L(mm)	Vials	
S078009	9"	230	3	6

重型盒式水平尺

Heavy-duty Aluminum Box Level

- 重型铝合金框架
- 两端装有ABS塑料盖帽，抗震性好
- 3个高可见度水泡
- Heavy duty aluminum frame
- ABS ends for shock absorption
- 3 high visible vials



Item no.	Size	L(mm)	Vials	
S078318	18"	450	2	6
S078324	24"	600	3	6
S078340	40"	1000	3	6
S078348	48"	1200	3	6

铝合金底座不锈钢角尺

Aluminum Combination Square

- 优质铝合金材质底座
- 不锈钢材质尺身，双公制刻度，操作便捷，耐用
- High quality aluminum stock
- Stainless steel blade with metric scales



Item no.	Size(mm)	
S079007	115x200	6
S079008	150x300	6

盒式水平尺

Box Level

- 铝合金材质
- 两端装有ABS塑料盖帽，抗震性好
- 3个高可见度水泡
- Aluminum frame
- ABS ends for shock absorption
- 3 high visible vials



Item no.	Size	L(mm)	Vials	
S078118	18"	450	3	6
S078124	24"	600	3	6
S078140	40"	1000	3	6
S078148	48"	1200	3	6

直角尺

Steel Rafter Square

- 采用优质钢材制造，经久耐用
- 正反面刻度清晰易读
- 刻度双向可读，使测量更方便
- 表面经防锈处理
- High-quality hardened steel for durability and long life
- Embossed graduations for easy reading on face and back
- Reverse reading scale makes measuring more efficient
- Treated with protective finish for rust-resistance

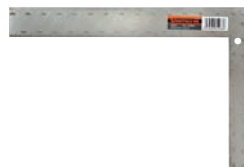

Item no.	Size(mm)	
S079001	200 x 300	12
S079002	400 x 600	6

不锈钢直尺

Stainless Steel Ruler

- 采用不锈钢，经久耐用
- 刻度清晰易读
- 双面公制刻度
- Stainless steel
- Easy to read
- Metric scale both sides

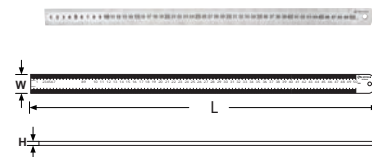

Item no.	L(mm)	W(mm)	H(mm)	
S079006	150	19	1.0	20
S079012	300	25	1.0	12
S079020	500	28	1.2	10
S079040	1000	33.5	1.5	10

数显游标卡尺 Digital Vernier Caliper

- 尺身采用不锈钢材质，硬化处理
- 采用三按键设计LCD，具有电源控制，任意位置清零及任意位置进行公英制转换
- 操作简单，读数方便精确
- 大液晶显示屏，紧固螺钉，准确锁定读数
- 符合DIN862标准，分度值0.01mm
- Made of stainless steel, all measuring face is hardened and finished
- Super extra high LCD display, powered by battery, metric / inch / fraction interchangeable
- System conversion and zero setting at any position, easy for operation and high accuracy
- Super extra high LCD, can display fraction reading
- Meets or exceeds DIN862 standard, division value: 0.01mm

操作简单，读数方便精确

采用不锈钢材质，硬化处理

带数据输出口RS232

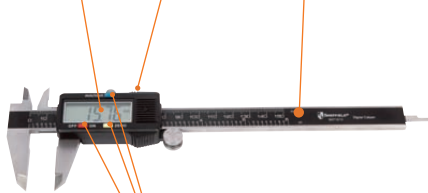

三按键设计LCD，具有电源控制，任意位置清零及任意位置进行公英制转换



符合DIN862标准，分度值0.01mm

Item no.	Size (mm)	Resolution (mm)	Precision (mm)	
S071012	150	0.01	±0.03	6

机械游标卡尺

Vernier Caliper

- 采用不锈钢材质，表面镀硬铬处理，高精度，耐磨
- 卡尺具有测量内径、外径、深度及台阶功能
- 尺身刻度采用激光刻线工艺加工，刻度清晰
- 符合DIN862标准，分度值0.02mm
- Made of stainless steel ,hard chromium plating surface, high-accuracy, anti-abrasion
- Caliper for measuring inner diameter, diameter, with depth and step function
- Rule body scale using laser engraving process, clear scale
- Meets or exceeds DIN862 standard, division value:0.02mm



Item no.	Size (mm)	Resolution (mm)	Precision (mm)	
S071001	150	0.02	±0.03	6
S071002	200	0.02	±0.03	6
S071003	300	0.02	±0.03	6

表盘式游标卡尺

Dial Vernier Caliper

- 采用不锈钢材质，表面镀硬铬处理，高精度，耐磨
- 卡尺具有测量内径、外径、深度及台阶功能
- 尺身刻度采用激光刻线工艺加工，刻度清晰
- 符合DIN862标准，分度值0.02mm
- Made of stainless steel ,hard chromium plating surface, high-accuracy, anti-abrasion
- Caliper for measuring inner diameter, diameter, with depth and step function
- Rule body scale using laser engraving process, clear scale
- Meets or exceeds DIN862 standard, division value:0.02mm



Item no.	Size (mm)	Resolution (mm)	Precision (mm)	
S071011	150	0.02	±0.03	6

外径千分尺

Micrometer

- 粉末冶金尺架，不锈钢活动测杆及固定测杆，使用寿命更长；
- 硬质合金测量面，耐磨，保证使用精度；
- 刻度采用激光刻线加工，清晰易读；
- 具有测力装置，千分螺丝锁紧开关，确保测量力度；
- Powder metallurgy rack, stainless rod, longer service life
- Carbide measuring surface, good for precision & anti-friction
- Laser calibration, easy to read
- With dynamometry installation & millesimal screw lock, precision guarantee



Item no.	Size(mm)	分度值(mm)	
S072001	0-25	0.01	1
S072002	25-50	0.01	1





 **SHEFFIELD**

敲击类工具 **STRIKING TOOLS**

冲类、凿类、冲凿类套装、撬棒、斧锤类
Punch & Chisel, Pry Bar, Hammer & Axe

3件套石工凿

3Pc Cold Chisel Set

- 凿体采用优质铬钒钢锻造，整体热处理
- 头部硬度达到HRC53-60,尾部经回火处理硬度为HRC32-46
- 六边形冲体设计，更坚固耐用
- 表面喷塑，耐腐蚀
- 适用建筑、装潢、石材加工及设备维修等行业
- Drop forged chrome vanadium steel, heat treated
- Hardened head to HRC53-60, hardened tail to HRC 32-46
- Heavy duty hex shank
- Powder coating finish for increased visibility
- Used for shaping, cutting, and chipping

CR-V



Item no.	Size	
S080001	10mm, 12mm, 16mm	3

6件套圆柱冲

6Pc Punch Set

- 采用铬钒钢锻造，整体热处理
- 六边形冲体设计，更坚固耐用
- 表面喷塑，耐腐蚀
- 适合机械加工与维修等
- Drop forged chrome vanadium steel, heat treated
- Heavy duty hex shank
- Powder coating finish for increased visibility
- Ideal for mechanician

CR-V



Item no.	Size	
S080003	1.5, 3, 4, 5, 6, 8mm	3

圆锥冲

Taper Punch

- 采用铬钒钢锻造，整体热处理
- 六边形冲体设计，更坚固耐用
- 表面喷塑，耐腐蚀
- 适合机械加工与维修等
- Drop forged chrome vanadium steel, heat treated
- Heavy duty hex shank
- Powder coating finish for increased visibility
- Ideal for mechanician

CR-V



Item no.	Size	(mm)	L(mm)	
S080101	2mm	9.5	138	3

圆柱冲

Pin Punch

- 采用铬钒钢锻造，整体热处理
- 六边形冲体设计，更坚固耐用
- 表面喷塑，耐腐蚀
- 适合机械加工与维修等
- Drop forged chrome vanadium steel, heat treated
- Heavy duty hex shank
- Powder coating finish for increased visibility
- Ideal for mechanician

CR-V



Item no.	Size	(mm)	L(mm)	
S080102	1.5mm	6	152	3
S080103	3mm	8	152	3
S080104	4mm	8	152	3
S080105	5mm	8	152	3
S080106	6mm	10	152	3
S080108	8mm	10	152	3

5件套样冲

5Pc Punch & Cold Chisel Set

- 凿体采用优质铬钒钢锻造，整体热处理
- 头部硬度达到HRC53-60,尾部经回火处理硬度为HRC32-46
- 六边形冲体设计，更坚固耐用
- 表面喷塑，耐腐蚀
- 适用建筑、装潢、石材加工及设备维修等行业
- Drop forged chrome vanadium steel, heat treated
- Hardened head to HRC53-60
- Heavy duty hex shank
- Powder coating finish for increased visibility
- Used for shaping, cutting, and chipping

CR-V



Item no.	Size	
S080002	石工凿1/2" (12mm), 中心冲1/4" (6mm), 3 圆柱冲5/16" (8mm), 圆锥冲3/32" (2.5mm), 尖凿3/16" (5mm)	3

12件套冲凿系列

12Pc Punch & Cold Chisel Set

- 采用铬钒钢锻造，整体热处理
- 六边形冲体设计，更坚固耐用
- 表面喷塑，耐腐蚀
- 适合机械加工与维修等
- Drop forged chrome vanadium steel, heat treated
- Heavy duty hex shank
- Powder coating finish for increased visibility
- Ideal for mechanician

CR-V



Item no.	Size	
S080004	石工凿：10, 12, 16mm； 3 圆柱冲：1.5, 3, 4, 5, 6mm, 圆锥冲：2mm；尖凿：6, 8mm	3

中心冲

Center Punch

- 采用铬钒钢锻造，整体热处理
- 六边形冲体设计，更坚固耐用
- 表面喷塑，耐腐蚀
- 适合机械加工与维修等
- Drop forged chrome vanadium steel, heat treated
- Heavy duty hex shank
- Powder coating finish for increased visibility
- Ideal for mechanician

CR-V



Item no.	Size	(mm)	L(mm)	
S080109	6mm	10	102	3
S080110	8mm	11	115	3



尖凿

Cape Chisel

- 采用优质铬钒钢锻造，整体热处理，经久耐用
- 表面喷塑，耐腐蚀
- 适合建筑、装潢、石材加工等行业
- Drop forged chrome-Vanadium steel blade, heat treated for durability
- Powder coating finish for increased visibility
- Ideal for cutting through and breaking up concrete

CR-V



Item no.	(mm)	L(mm)	
S080201	10	152	3

扁凿

Cold Chisel

- 采用优质铬钒钢锻造，整体热处理，经久耐用
- 表面喷塑，耐腐蚀
- 适合建筑、装潢、石材加工等行业
- Drop forged chrome-Vanadium steel blade, heat treated for durability
- Powder coating finish for increased visibility
- Ideal for cutting and splitting hard stone, brick and concrete

CR-V



Item no.	Size	(mm)	L(mm)	
S080210	10	8	142	3
S080212	12	10	152	3
S080216	16	13	172	3
S080219	19	16	175	3
S080222	22	19	203	3
S080225	25	19	305	3

木工凿

Wood Chisel

- 刀身采用铬钒钢锻造，整体热处理，经久耐用
- 刀刃精密打磨
- 手柄尾端可以用锤子敲击作业
- 手柄握持舒适
- Drop forged chrome-vanadium steel blade, heat treated for edge retention
- Blade edge honed
- Steel butt designed for heavy pounding with a hammer or mallet
- Ergonomic grip handle

CR-V



Item no.	Size(mm)	L(mm)	
S080312	12	260	6
S080319	19	260	6
S080325	25	260	6

胶柄石工尖凿

Cape Chisel

- 采用优质铬钒钢锻造，整体热处理，经久耐用
- 表面喷塑，耐腐蚀
- 带保护的手柄符合人体工程学设计
- 适合建筑、装潢、石材加工等行业
- Drop forged chrome-Vanadium steel blade, heat treated for durability
- Powder coating finish for increased visibility
- Ergonomic comfort grip handle with Bi-Material hand guard
- Ideal for cutting through and breaking up concrete

CR-V



Item no.	(mm)	L(mm)	
S080202	19	305	3

合金划线器

Scribe Marking Tool

- 手柄采用铝合金制造，带口袋夹
- 头部采用碳化钨压入手柄，防止松动
- Anodized aluminum body with pocket clip
- Solid tungsten carbide tip pressed into handle to prevent tip from loosening during use

CR-V



Item no.	Size	L(mm)	
S080111	6mm	152	12

撬棒

Pry Bar

- 采用优质铬钒钢锻造
- 经热处理，坚固耐用
- 弯角设计，增加作业扭矩
- 尾端采用尖头设计
- 表面喷塑，耐腐蚀
- Drop forged chrome vanadium steel
- Heat-treated to resist bending and breaking
- Angled chisel end for extra leverage when prying
- Slim tapered end with fine point tip
- Powder coating finish

CR-V



Item no.	Size	Angled	(mm)	
S081014	14"(355mm)	30°	16	6
S081024	24"(610mm)	30°	16	6
S081036	36"(914mm)	30°	19	4
S081059	59"(1500mm)	0°	25	2

胶柄扁凿

Cold Chisel

- 采用优质铬钒钢锻造，整体热处理，经久耐用
- 表面喷塑，耐腐蚀
- 带保护的手柄符合人体工程学设计
- 适合建筑、装潢、石材加工等行业
- Drop forged Chrome-Vanadium steel blade, heat treated for durability
- Powder coating finish for increased visibility, rust-resistant
- Ergonomic comfort grip handle with Bi-Material hand guard
- Ideal for cutting through and breaking up concrete

CR-V



Item no.	Size(mm)	(mm)	L(mm)	
S080203	25	19	305	3

3件套木工凿

3Pc Wood Chisel Set

- 刀身采用铬钒钢锻造，整体热处理，经久耐用
- 刀刃精密打磨
- 手柄尾端可以用锤子敲击作业
- 手柄握持舒适
- Drop forged Chrome-Vanadium steel blade, heat treated for edge retention
- Blade edge honed
- Steel butt designed for heavy pounding with a hammer or mallet
- Ergonomic grip handle

CR-V



Item no.	Contents	
S080301	12mm, 19mm, 25mm	6

起钉器

Wrecking Bar

- 采用优质铬钒钢锻造
- 经热处理，坚固耐用
- 90°角设计，增加作业扭矩
- U型头设计，不会损伤作业表面
- 表面喷塑，耐腐蚀
- Drop forged chrome vanadium steel
- Heat-treated to resist bending and breaking
- 90 degree angled chisel end for extra leverage when prying
- U-shaped prying end won't damage surfaces
- Painted finished body

CR-V



Item no.	Size	Angled	
S081114	14"	90°	6
S081124	24"	90°	6
S081136	36"	90°	4

防震羊角锤

Claw Hammer, Anti-Vibration Grip

- 采用优质钢材锻造，整体热处理
- 一体化设计，表面抛光
- 防震橡胶手柄，牢固耐用，并能有效减小敲击产生的回震
- 符合美国ANSI标准
- Carbon steel, heat-treated
- Drop forged in one piece, fully polished
- Anti-Vibration rubber grip handle
- Meets or exceeds ANSI standard



Item no.	Size	L(mm)	
S088002	20 oz	338	6

八合一羊角锤

Multifunctional hammer

- 采用优质钢材锻造
- 管钳，锤，羊角，梅花扳手，起钉器，撬棒，活扳手等功能，适应复杂环境下抢险、应急使用
- Drop Forged Carbon steel
- Pipe wrench, Adjustable wrench, Hammer, Claw, Ring end spanner, Nails

新品



Item no.	Size	
S037253	18'(470mm)	6

钢柄羊角锤

Claw Hammer, Tubular Handle

- 锤头采用优质钢材锻造
- 锤头经热处理，表面抛光
- 钢管手柄，牢固耐用
- 符合美国ANSI标准
- Drop forged Carbon steel
- Fully heat-treated & polished face
- Comfortable fiberglass handle
- Meets or exceeds ANSI standard



Item no.	Size	L(mm)	
S088008	8 oz	280	6
S088016	16 oz	335	6

纤维柄羊角锤

Claw Hammer, Fiberglass Handle

- 锤头采用优质钢材锻造
- 锤头经热处理，表面抛光
- 玻璃纤维柄，牢固耐用
- 符合美国ANSI标准
- Drop forged Carbon steel
- Fully heat-treated & polished face
- Comfortable fiberglass handle
- Meets or exceeds ANSI standard



Item no.	Size	L(mm)	
S088116	16 oz	335	6
S088120	20 oz	335	6
S088124	24 oz	335	6

硬木柄羊角锤

Claw Hammer, Wood Handle

- 锤头采用优质钢材锻造
- 锤头经热处理，表面抛光
- 硬木柄，牢固耐用
- 符合美国ANSI标准
- Drop forged Carbon steel
- Fully heat-treated & polished face
- Comfortable hard wood handle
- Meets or exceeds ANSI standard



Item no.	Size	L(mm)	
S088208	8 oz	290	6
S088212	12 oz	310	6
S088216	16 oz	310	6
S088220	20 oz	310	6

纤维柄圆头锤

Ball Pein Hammer, Fiberglass Handle

- 锤头采用优质钢材锻造
- 锤头经热处理，表面抛光
- 玻璃纤维柄，牢固耐用
- 符合美国ANSI标准
- Drop forged Carbon steel
- Fully heat-treated & polished face
- Comfortable fiberglass handle
- Meets or exceeds ANSI standard



Item no.	Size	L(mm)	
S088316	16 oz	335	6
S088324	24 oz	335	6
S088332	32 oz	335	6

圆头锤

Ball Pein Hammer, Hickory Handle

- 锤头采用优质钢材锻造
- 锤头经热处理，表面抛光
- 硬木柄，牢固耐用
- 符合美国ANSI标准
- Drop forged Carbon steel
- Fully heat-treated & polished face
- Comfortable hard wood handle
- Meets or exceeds ANSI standard



Item no.	Size	L(mm)	
S088408	8 oz	290	6
S088412	12 oz	336	6
S088416	16 oz	336	6
S088424	24 oz	356	6
S088432	32 oz	376	6
S088440	40 oz	376	6



木柄钳工锤

Mechanics Hammer, Hickory Handle

- 锤头采用优质钢材锻造
- 锤头经热处理，表面抛光
- 硬木柄，牢固耐用
- 符合美国ANSI标准
- Drop forged Carbon steel
- Fully heat-treated & polished face
- Comfortable hard wood handle
- Meets or exceeds ANSI standard



Item no.	Size	L(mm)	
S088620	200g	285	6
S088630	300g	300	6
S088650	500g	320	6
S088680	800g	350	6

木柄安装锤

Double-Face Dead Blow Hammer, Hickory Handle

- 锤头采用聚氨酯材料制造，软性半透明
- 胡桃木柄，牢固耐用
- 有效降低回震及反弹
- 无敲击火花，可用于防爆作业
- Replaceable polyurethane faces
- Comfortable hickory handle
- Non-Rebounding
- Non-Spark, explosion-proof operation



Item no.	Size(mm)	L(mm)	
S088722	22	300	6
S088728	28	300	6
S088735	35	320	6
S088742	42	320	6
S088750	60	385	4

钢斧

Axe

- 斧头采用优质钢材锻造
- 斧头经热处理，表面抛光
- 舒适钢管手柄
- 带皮护套
- 符合美国ANSI标准
- Drop forged carbon steel
- Fully heat-treated & polished face
- Comfortable rubber grip handle
- With leather sheath
- Meets or exceeds ANSI standard



Item no.	Size	L(mm)	
S089020	20 oz	340	6

重型防震橡胶锤

Dead Blow Hammer

- 锤头采用进口尼龙材质，耐高温，耐腐蚀，高耐磨
- 锤体和手柄采用合金钢材质，内部增加钢珠，增加打击力，有效防止反弹
- 手柄采用黑色TPR软性护套，握持舒适，减少工作强度
- 锤头采用嵌入式结构，不易脱落
- Hammer head adopts imported nylon material, with heat resistance, anti-corrosion and high wear resistance features
- Hammer body and handle adopt alloy steel with steel ball in the head to enhance striking force and reduce rebounding
- Black TPR material coated handle ensures comfortable using
- Embedded hammer head structure avoids falling off



Item no.	Size	
S088713	40mm	6
S088715	60mm	6

胶锤

Rubber Mallet, Hickory Handle

- 橡胶锤头，表面柔软，不损伤敲击表面
- 胡桃木柄，牢固耐用
- 有效降低回震及反弹
- 无敲击火花，可用于防爆作业
- Solid rubber head
- Comfortable hickory handle
- Non-Rebounding
- Non-Spark



Item no.	Size	(mm)	L(mm)	
S088816	16 oz	56	343	6
S088824	24 oz	62	343	6

纤维柄八角锤

Sledge Hammer

- 双色PP+TPR手柄，耐用舒适
- 锤头采用优质高碳钢整体锻造加工，强度高，耐冲击
- Molded PP&TPR soft handle for comfort
- Forged carbon steel head for high impact-resistance



Item no.	Size	L(mm)	
S089102	2LB	260	6
S089103	3LB	280	6
S089104	4LB	350	4
S089106	6LB	880	2
S089108	8LB	880	2
S089110	10LB	880	2
S089112	12LB	880	2
S089114	14LB	880	2

防震橡胶锤锤头

Replaceable Hammer Tip

- 锤头采用进口尼龙材质，耐高温，耐腐蚀，高耐磨性
- Hammer head adopts imported nylon material, with heat resistance, anti-corrosion and high wear resistance features



Item no.	Size	
S088718	40mm	6
S088720	60mm	6

无弹力橡胶锤

Dead Blow Hammer

- 锤头采用进口NBR丁腈橡胶材质，耐高温，耐油耐腐蚀，高耐磨性
- 锤头内部增加钢珠，增加打击力，有效防止反弹
- 人体工程学手柄，握持舒适，减少工作强度
- Hammer head adopts imported NBR material, with heat resistance, anti-corrosion, oil resistant and wear resistance features
- Non-Rebounding
- Ergonomic handle

新品



Item no.	Size(LB)	(mm)	
S088935	0.5	35±0.5mm	6
S088945	1	45±0.5mm	6
S088955	1.5	55±0.5mm	6
S088965	2.5	65±0.5mm	6

铜锤

Copper Hammer

- 锤头采用优质紫铜加工，敲击时不损伤工件表面，不产生火花
- 双色PP+TPR手柄，握持舒适耐用
- Precision-machined solid copper head
- Non-sparking head will not mar finished steel surfaces
- Bi-material soft grip handle for comfort



Item no.	Size	
S089301	1LB	6
S089302	2LB	3
S089303	3LB	2



表面修整类工具 **FINISHING TOOLS**

金刚石锉、修边器、钳工锉
Diamond Needle File, Deburring Tool, File

3件套金刚石整形锉

3Pc Diamond Needle File Set

- 表面采用高强度人造钻石电镀
- 适用锉削小尺寸的特殊工件、精密零件，也可用于珠宝首饰、工艺品的加工。
- 粒度：150目
- Fine diamond grit
- Perfect for machinists, gunsmiths, jewelers and hobbyists
- 150 grit

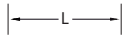

Item no.	Size(mm)	L(mm)	
S090001	3 x 140	50	10
S090002	4 x 160	50	10
S090003	5 x 180	70	10

什锦锉刀套装

Assorted Files Set

- 锉刀采用高级合金钢材质，锉齿表面特殊热处理涂层，经久耐磨
- 用于锉削小尺寸的特殊工件及精密零件
- 沾塑手柄，使用轻便
- Quality alloy steel material, special heat treatment to file surface for durability
- For small size special workpieces or precise parts
- Dipped handle for easy operation



Item no.	Size(mm)	L(mm)	
S090007	3X140mm	50	12
S090008	4X160mm	50	12
S090009	5X180mm	70	12

金刚石尖头圆锉

Round Needle File

- 表面采用高强度人造钻石电镀
- 适用锉削小尺寸的特殊工件、精密零件，也可用于珠宝首饰、工艺品的加工。
- 锉刀规格：3x140mm；工作面长度：50mm；粒度：150目
- Fine diamond grit
- Perfect for machinists, gunsmiths, jewelers and hobbyists
- Size: 3x140mm, 150 grit
- working surface length 50mm

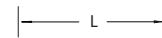

Item no.	Size(mm)	L(mm)	
S090103	3 x 140mm	50	20

5件套金刚石整形锉

5Pc Diamond Needle File Set

- 表面采用高强度人造钻石电镀
- 适用锉削小尺寸的特殊工件、精密零件，也可用于珠宝首饰、工艺品的加工。
- 粒度：150目
- Fine diamond grit
- Perfect for machinists, gunsmiths, jewelers and hobbyists
- Size: 5x180mm, 150 grit

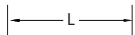

Item no.	Size(mm)	L(mm)	
S090004	5 x 180	70	10

金刚石平头扁锉

Flat Needle File

- 表面采用高强度人造钻石电镀
- 适用锉削小尺寸的特殊工件、精密零件，也可用于珠宝首饰、工艺品的加工。
- 锉刀规格：3x140mm；工作面长度：50mm；粒度：150目
- Fine diamond grit
- Perfect for machinists, gunsmiths, jewelers and hobbyists
- Size: 3x140mm, 150 grit
- Dipped grip handle

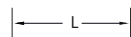

Item no.	Size(mm)	L(mm)	
S090101	3 x 140	50	20

金刚石平头扁锉

Flat Needle File

- 表面采用高强度人造钻石电镀
- 适用锉削小尺寸的特殊工件、精密零件，也可用于珠宝首饰、工艺品的加工。
- 锉刀规格：4x160mm；工作面长度：50mm；粒度：150目
- Fine diamond grit
- Perfect for machinists, gunsmiths, jewelers and hobbyists
- Size: 4x160mm, 150 grit
- working surface length 50mm

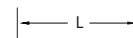

Item no.	Size(mm)	L(mm)	
S090104	4 x 160mm	50	20

10件套金刚石整形锉

10Pc Diamond Needle File Set

- 表面采用高强度人造钻石电镀
- 适用锉削小尺寸的特殊工件、精密零件，也可用于珠宝首饰、工艺品的加工。
- 粒度：150目
- Fine diamond grit
- Perfect for machinists, gunsmiths, jewelers and hobbyists
- Size: 3x140mm, 150 grit



Item no.	Size(mm)	L(mm)	
S090005	3 x 140	50	10
S090006	4 x 160	50	10

金刚石尖头半圆锉

Half Round Needle File

- 表面采用高强度人造钻石电镀
- 适用锉削小尺寸的特殊工件、精密零件，也可用于珠宝首饰、工艺品的加工。
- 锉刀规格：3x140mm；工作面长度：50mm；粒度：150目
- Fine diamond grit
- Perfect for machinists, gunsmiths, jewelers and hobbyists
- Size: 3x140mm, 150 grit
- working surface length 50mm

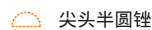

Item no.	Size(mm)	L(mm)	
S090102	3 x 140	50	20

金刚石尖头半圆锉

Half Round Needle File

- 表面采用高强度人造钻石电镀
- 适用锉削小尺寸的特殊工件、精密零件，也可用于珠宝首饰、工艺品的加工。
- 锉刀规格：4x160mm；工作面长度：50mm；粒度：150目
- Fine diamond grit
- Perfect for machinists, gunsmiths, jewelers and hobbyists
- Size: 4x160mm, 150 grit
- working surface length 50mm

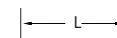

Item no.	Size(mm)	L(mm)	
S090105	4 x 160	50	20

金刚石尖头圆锉

Round Needle File

- 表面采用高强度人造钻石电镀
- 适用锉削小尺寸的特殊工件、精密零件，也可用于珠宝首饰、工艺品的加工。
- 锉刀规格：4x160mm；工作面长度：50mm；粒度：150目
- Fine diamond grit
- Perfect for machinists, gunsmiths, jewelers and hobbyists
- Size: 4x160mm, 150 grit
- working surface length 50mm

尖头圆锉



Item no.	Size(mm)	L(mm)	
S090106	4 x 160	50	20

金刚石平头扁锉

Flat Needle File

- 表面采用高强度人造钻石电镀
- 适用锉削小尺寸的特殊工件、精密零件，也可用于珠宝首饰、工艺品的加工。
- 锉刀规格：5x180mm；工作面长度：70mm；粒度：150目
- Fine diamond grit
- Perfect for machinists, gunsmiths, jewelers and hobbyists
- Size: 5x180mm, 150 grit
- working surface length 50mm

平头扁锉



Item no.	Size(mm)	L(mm)	
S090107	5 x 180	70	20

金刚石尖头半圆锉

Half Round Needle File

- 表面采用高强度人造钻石电镀
- 适用锉削小尺寸的特殊工件、精密零件，也可用于珠宝首饰、工艺品的加工。
- 锉刀规格：5x180mm；工作面长度：70mm；粒度：150目
- Fine diamond grit
- Perfect for machinists, gunsmiths, jewelers and hobbyists
- Size: 5x180mm, 150 grit
- working surface length 50mm 尖头半圆锉



Item no.	Size(mm)	L(mm)	
S090108	5 x 180	70	20

金刚石尖头圆锉

Round Needle File

- 表面采用高强度人造钻石电镀
- 适用锉削小尺寸的特殊工件、精密零件，也可用于珠宝首饰、工艺品的加工。
- 锉刀规格：5x180mm；工作面长度：70mm；粒度：150目
- Fine diamond grit
- Perfect for machinists, gunsmiths, jewelers and hobbyists
- Size: 5x180mm, 150 grit
- Dipped grip handle 尖头圆锉



Item no.	Size(mm)	L(mm)	
S090109	5 x 180	70	20

修边器

Deburring Tool

- 刀片采用优质高速钢，硬度可达HRC65
- 能有效去除钢、铜、铝、PP塑料等工件的飞边，毛刺
- 用于处理边角、管状、片状材料
- 手柄符合人体工程学设计，使用舒适美观
- High speed steel replaceable blade
- For deburring steel, plastic, aluminum and copper
- Quick deburring of edges, tubular and sheet materials
- Ergonomic comfort grip handle



Item no.	Size	L(mm)	
S092002	5.5"	140	12

加强修边器

Deburring Tool

- 刀片采用优质HSS材质，硬度可达到HRC65
- 能有效去除钢、铜、铝、PP塑料等工件的飞边，毛刺
- 用于处理边角、管状、片装材料
- 手柄符合人体工程学设计，使用舒适美观
- High speed steel blade
- For deburring steel, copper, aluminum, plastic, etc.
- For polishing & deburring work in edge or corner, pipe, sheet material
- Ergonomical soft handle for comfort



Item no.	Size	L(mm)	
S092003	7"	170	12

修边器刀片

Deburring Blade

- 刀片采用优质高速钢
- 能有效去除各种材料的飞边、毛刺等
- 刀片直径：3.2mm
- High speed steel
- Replacement blade for deburring tool
- For deburring steel, plastic, aluminum and copper



Item no.	Size	Num.(pc)	
S092010	48mm	10	12

粗齿平锉

Coarse Flat File

- 锉齿等级：粗齿
- 锉齿表面特殊热处理涂层，经久耐磨
- 橡塑手柄，舒适防滑
- Diamond grit: Coarse
- Coated teeth for durability
- Comfortable rubber grip handle 粗齿平锉



Item no.	Size	L(mm)	
S099101	6"	260	12
S099102	8"	310	12
S099103	10"	360	12
S099104	12"	410	6

中齿平锉

Medium Flat File

- 锉齿等级：中齿
- 锉齿表面特殊热处理涂层，经久耐磨
- 橡塑手柄，舒适防滑
- Diamond grit: Medium
- Coated teeth for durability
- Comfortable rubber grip handle 中齿平锉



Item no.	Size	L(mm)	
S099105	6"	260	12
S099106	8"	310	12
S099107	10"	360	12
S099108	12"	410	6

细齿平锉

Fine Flat File

- 锉齿等级：细齿
- 锉齿表面特殊热处理涂层，经久耐磨
- 橡塑手柄，舒适防滑
- Diamond grit: Fine
- Coated teeth for durability
- Comfortable rubber grip handle 细齿平锉



Item no.	Size	L(mm)	
S099109	6"	260	12
S099110	8"	310	12
S099111	10"	360	12
S099112	12"	410	6

粗齿半圆锉

Coarse Half Round File

- 锉齿等级：粗齿
- 锉齿表面特殊热处理涂层，经久耐磨
- 橡塑手柄，舒适防滑
- 适用于锉削有凹凸面的工件
- Diamond grit: Coarse
- Coated teeth for durability
- Comfortable rubber grip handle 粗齿半圆锉
- Used on concave and convex as well as flat surfaces



Item no.	Size	L(mm)	
S099201	6"	260	12
S099202	8"	310	12
S099203	10"	360	12
S099204	12"	410	6



中齿半圆锉

Medium Half Round File

- 锉齿等级：中齿
- 锉齿表面特殊热处理涂层，经久耐磨
- 橡塑手柄，舒适防滑
- 适用于锉削有凹凸面的工件
- Diamond grit: Medium
- Coated teeth for durability
- Comfortable rubber grip handle
- Used on concave and convex as well as flat surfaces

中齿半圆锉

升级



Item no.	Size	L(mm)	个
S099205	6"	260	12
S099206	8"	310	12
S099207	10"	360	12
S099208	12"	410	6

粗齿三角锉

Coarse Triangular File

- 锉齿等级：粗齿
- 锉齿表面特殊热处理涂层，经久耐磨
- 橡塑手柄，舒适防滑
- Diamond grit: Coarse
- Coated teeth for durability
- Comfortable rubber grip handle

粗齿三角锉

升级



Item no.	Size	L(mm)	个
S099409	6"	260	12
S099410	8"	310	12
S099411	10"	360	12
S099412	12"	410	6

粗齿方锉

Coarse Square File

- 锉齿等级：粗齿
- 锉齿表面特殊热处理涂层，经久耐磨
- 橡塑手柄，舒适防滑
- Diamond grit: Coarse
- Coated teeth for durability
- Comfortable rubber grip handle

粗齿方锉

升级



Item no.	Size	L(mm)	个
S099509	6"	260	12
S099510	8"	310	12
S099511	10"	360	12
S099512	12"	410	6

细齿半圆锉

Fine Half Round File

- 锉齿等级：细齿
- 锉齿表面特殊热处理涂层，经久耐磨
- 橡塑手柄，舒适防滑
- 适用于锉削有凹凸面的工件
- Diamond grit: Fine
- Coated teeth for durability
- Comfortable rubber grip handle
- Used on concave and convex as well as flat surfaces

细齿半圆锉

升级



Item no.	Size	L(mm)	个
S099209	6"	260	12
S099210	8"	310	12
S099211	10"	360	12
S099212	12"	410	6

中齿三角锉

Medium Triangular File

- 锉齿等级：中齿
- 锉齿表面特殊热处理涂层，经久耐磨
- 橡塑手柄，舒适防滑
- Diamond grit: Medium
- Coated teeth for durability
- Comfortable rubber grip handle

中齿三角锉

升级



Item no.	Size	L(mm)	个
S099405	6"	260	12
S099406	8"	310	12
S099407	10"	360	12
S099408	12"	410	6

中齿方锉

Medium Square File

- 锉齿等级：中齿
- 锉齿表面特殊热处理涂层，经久耐磨
- 橡塑手柄，舒适防滑
- Diamond grit: Medium
- Coated teeth for durability
- Comfortable rubber grip handle

中齿方锉

升级



Item no.	Size	L(mm)	个
S099505	6"	260	12
S099506	8"	310	12
S099507	10"	360	12
S099508	12"	410	6

中齿圆锉

Medium Round File

- 锉齿等级：中齿
- 锉齿表面特殊热处理涂层，经久耐磨
- 橡塑手柄，舒适防滑
- 适用于曲面或孔的锉削
- Diamond grit: Medium
- Coated teeth for durability
- Comfortable rubber grip handle
- Use for forming/shaping holes and curves

中齿圆锉

升级



Item no.	Size	L(mm)	个
S099305	6"	260	12
S099306	8"	310	12
S099307	10"	360	12
S099308	12"	410	6

细齿三角锉

Fine Triangular File

- 锉齿等级：细齿
- 锉齿表面特殊热处理涂层，经久耐磨
- 橡塑手柄，舒适防滑
- 适用于锉削有凹凸面的工件
- Diamond grit: Fine
- Coated teeth for durability
- Comfortable rubber grip handle
- Used on concave and convex as well as flat surfaces

细齿三角锉

升级



Item no.	Size	L(mm)	个
S099401	6"	260	12
S099402	8"	310	12
S099403	10"	360	12
S099404	12"	410	6

细齿方锉

Fine Flat File

- 锉齿等级：细齿
- 锉齿表面特殊热处理涂层，经久耐磨
- 橡塑手柄，舒适防滑
- Diamond grit: Fine
- Coated teeth for durability
- Comfortable rubber grip handle

细齿方锉

升级



Item no.	Size	L(mm)	个
S099501	6"	260	12
S099502	8"	310	12
S099503	10"	360	12
S099504	12"	410	6



刃具类工具 **DRILLING TOOLS**

丝锥板牙及组套、绞手、直柄麻花钻及套装
HSS Ground Thread Tap, Stocks, Cobalt Stub Drills

32件套公制高速钢丝锥板牙组套

32Pc HSS Ground Thread Tap

- 优质HSS M2高速钢材料，全磨制工艺加工，确保使用硬度，切削速度及寿命
- 采用DIN标准生产
- Qualified HSS M2 high-speed steel, fully milled, ensured hardness, cutting speed and durable usage
- Meet DIN standard



Item no.	Size	
S133002	32pc	1

- 7件套丝锥 头锥M3x0.5,M4x0.7,M5x0.8,M6x1,M8x1.25,M10x1.5,M12x1.75
- 7件套丝锥 二锥M3x0.5,M4x0.7,M5x0.8,M6x1,M8x1.25,M10x1.5,M12x1.75
- 7件套丝锥 尾锥M3x0.5,M4x0.7,M5x0.8,M6x1,M8x1.25,M10x1.5,M12x1.75
- 7件套板牙 M3x0.5,M4x0.7,M5x0.8,M6x1,M8x1.25,M10x1.5,M12x1.75
- 2件 丝锥绞手1/2", 板牙绞手1"
- 2件 一字螺丝刀3x75mm, 螺纹规

21件套公制高速钢丝锥组套

21Pc HSS Ground Thread Tap

- 优质HSS M2高速钢材料，全磨制工艺加工，确保使用硬度，切削速度及寿命
- 采用DIN标准生产
- Qualified HSS M2 high-speed steel, fully milled, ensured hardness, cutting speed and durable usage
- Meet DIN standard



Item no.	Size	
S133001	21pc	1

- 7件套丝锥 头锥M3x0.5,M4x0.7,M5x0.8,M6x1,M8x1.25,M10x1.5,M12x1.75
- 7件套丝锥 二锥M3x0.5,M4x0.7,M5x0.8,M6x1,M8x1.25,M10x1.5,M12x1.75
- 7件套丝锥 尾锥M3x0.5,M4x0.7,M5x0.8,M6x1,M8x1.25,M10x1.5,M12x1.75

公制高速钢板牙

HSS Ground Thread Tap

- 优质HSS M2 高速钢材料，全磨制工艺加工，确保使用硬度，切削速度及寿命
- 采用ISO529标准生产
- Qualified HSS M2 high-speed steel, fully milled, ensured hardness, cutting speed and durable usage
- Meet ISO529 standard



Item no.	Size(mm)	
S135001	M3X0.5	6
S135002	M4X0.7	6
S135003	M5X0.8	6
S135004	M6X1.0	6
S135005	M8X1.25	6
S135006	M10X1.5	6
S135007	M12X1.75	6

板牙绞手

Die Stocks

- 夹座及夹头采用锌合金材质压铸，手柄采用优质合金钢材质，滚花设计，确保夹持扭矩
- Zinc alloyed steel for base and jaw, qualified bearing steel for handle, knurled, ensured torque



Item no.	Size	
S135101	M3~M12	6

公制高速钢机用丝锥

HSS Ground Thread Tap

- 优质HSS M2高速钢材料，全磨制工艺加工，确保使用硬度，切削速度及寿命
- 采用ISO529标准生产
- Qualified HSS M2 high-speed steel, fully milled, ensured hardness, cutting speed and durable usage
- Meet ISO529 standard



Item no.	Size(mm)	
S134001	M3X0.5	12
S134002	M4X0.7	12
S134003	M5X0.8	12
S134004	M6X1.0	12
S134005	M8X1.25	12
S134006	M10X1.5	12
S134007	M12X1.75	12

丝锥绞手

Tap Wrench

- 手柄采用优质轴承钢，滚花设计，夹头采用合金钢材质加工，确保夹持扭矩
- Qualified bearing steel for handle, knurled, alloyed steel for jaws, ensured torque



Item no.	Size	
S134011	M3~M12	6

T型棘轮丝锥绞手

T-Type Ratchst Tap Wrench

- 手柄采用优质轴承钢，夹头采用合金钢材质加工，确保夹持扭矩
- 特有双向棘轮结构，锌合金旋钮，使用方便，省力，寿命长
- Qualified bearing steel for handle, alloyed steel for jaws, ensured torque
- Unique dual ratchet construction, zinc alloy knob, easy for usage, power-saving and long life usage



Item no.	Size	
S134012	M3~M10	10
S134013	M5~M12	10

公制镀钛高速钢直柄麻花钻

HSS Ti Coated Stub Drills

- 优质HSS 6542高速钢材质，全磨制工艺加工，确保切削硬度及速度
- 刃口采用135度双后角工艺加工，保证定位准确
- Qualified HSS 6542 steel, fully milled, ensured hardness and cutting speed.
- Adopts 135 degree dual rear degree technology for cutting edge, making accurate positioning.

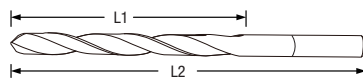

Item no.	Size(mm)	L1(mm)	L2(mm)	
S136001	1.0	12	34	10
S136002	1.5	18	40	10
S136003	2.0	24	49	10
S136004	2.2	27	53	10
S136005	2.5	30	57	10
S136006	2.8	33	61	10
S136007	3.0	33	61	10
S136008	3.2	36	65	10
S136009	3.5	36	70	10
S136010	3.8	43	75	10
S136011	4.0	43	75	10
S136012	4.2	43	75	10
S136013	4.5	47	80	10
S136014	4.8	52	86	10
S136015	5.0	52	86	10
S136016	5.2	52	86	10
S136017	5.5	57	93	10
S136018	5.8	57	93	10
S136019	6.0	57	93	10
S136020	6.2	63	101	10
S136021	6.5	63	101	10
S136022	6.8	69	109	10
S136023	7.0	69	109	10
S136024	7.5	69	109	10
S136025	8.0	75	117	10
S136037	8.2	75	117	10
S136026	8.5	75	117	10
S136027	9.0	81	125	10
S136028	9.5	81	125	10
S136029	10.0	87	133	10
S136030	10.2	87	133	10
S136031	10.5	87	133	5
S136032	11.0	94	142	5
S136033	11.5	94	142	5
S136034	12.0	101	151	5
S136035	12.5	101	151	5
S136036	13.0	101	151	5

公制含钴高速钢直柄麻花钻

HSS-Co.5% Cobalt Stub Drills

- 优质HSS M35含钴5%高速钢材质，全磨制工艺加工，确保切削硬度及速度
- 刃口采用135度双后角工艺加工，保证定位准确
- Qualified HSS M35 steel (Co: 5%), fully milled, ensured hardness and cutting speed.
- Adopts 135 degree dual rear degree technology for cutting edge, making accurate positioning.

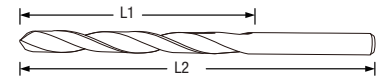

Item no.	Size(mm)	L1(mm)	L2(mm)	
S137001	1.0	12	34	10
S137002	1.5	18	40	10
S137003	2.0	24	49	10
S137004	2.5	30	57	10
S137005	2.8	33	61	10
S137006	3.0	33	61	10
S137007	3.2	36	65	10
S137008	3.5	39	70	10
S137009	4.0	43	75	10
S137010	4.2	43	75	10
S137011	4.5	47	80	10
S137012	4.8	52	86	10
S137013	5.0	52	86	10
S137014	5.2	52	86	10
S137015	5.5	57	93	10
S137016	6.0	57	93	10
S137017	6.5	63	101	10
S137018	6.8	69	109	10
S137019	7.0	69	109	10
S137020	7.5	69	109	10
S137021	8.0	75	117	10
S137022	8.5	75	117	10
S137023	9.0	81	125	10
S137024	9.5	81	125	10
S137025	10.0	87	133	10
S137026	10.2	87	133	10
S137027	10.5	87	133	5
S137028	11.0	94	142	5
S137029	11.5	94	142	5
S137030	12.0	101	151	5
S137031	12.5	101	151	5
S137032	13.0	101	151	5



13件套直柄镀钛高速钢麻花钻

13Pcs Hss Ti Coated Stub Drills Set

- 优质HSS 6542高速钢材质，全磨制工艺加工，确保切削硬度及速度
- 刃口采用135度双后角工艺加工，保证定位准确
- Qualified HSS 6542 steel, fully milled, ensured hardness and cutting speed .
- Adopts 135 degree dual rear degree technology for cutting edge, making accurate positioning.



Item no.	
S133011	6
13件 公制直柄镀钛高速钢麻花钻1.5, 2.0, 2.5, 3.0, 3.2, 3.5,4.0, 4.5, 4.8, 5.0, 5.5, 6.0, 6.5mm	

25件套直柄镀钛高速钢麻花钻

25Pcs Hss Ti Coated Stub Drills Set

- 优质HSS 6542高速钢材质，全磨制工艺加工，确保切削硬度及速度
- 刃口采用135度双后角工艺加工，保证定位准确
- Qualified HSS 6542 steel, fully milled, ensured hardness and cutting speed
- Adopts 135 degree dual rear degree technology for cutting edge, making accurate positioning



Item no.	
S133013	6
25件 公制直柄镀钛高速钢麻花钻1.0,1.5,2.0,2.5,3.0, 3.5,4.0,4.5,5.0,5.5,6.0,6.5,7.0,7.5,8.0,8.5,9.0,9.5,10.0,10.5,11,11.5,12,12.5,13.0mm	

19件套直柄高速钢含Co麻花钻

19Pcs Hss-Co.5% Cobalt Stub Drills Set

- 优质HSS M35含钴5%高速钢材质，全磨制工艺加工，确保切削硬度及速度
- 刃口采用135度双后角工艺加工，保证定位准确
- Qualified HSS M35 steel (Co: 5%), fully milled, ensured hardness and cutting speed.
- Adopts 135 degree dual rear degree technology for cutting edge, making accurate positioning.



Item no.	
S133022	6
19件 公制直柄高速钢含Co麻花钻1.0,1.5,2.0,2.5,3.0,3.5,4.0,4.5,5.0,5.5,6.0,6.5,7.0,7.5,8.0,8.5,9.0,9.5,10.0mm	

19件套直柄镀钛高速钢麻花钻

19Pcs Hss Ti Coated Stub Drills Set

- 优质HSS 6542高速钢材质，全磨制工艺加工，确保切削硬度及速度
- 刃口采用135度双后角工艺加工，保证定位准确
- Qualified HSS 6542 steel, fully milled, ensured hardness and cutting speed.
- Adopts 135 degree dual rear degree technology for cutting edge, making accurate positioning.



Item no.	
S133012	6
19件 公制直柄镀钛高速钢麻花钻1.0,1.5,2.0,2.5,3.0, 3.5,4.0,4.5,5.0,5.5,6.0,6.5,7.0,7.5,8.0,8.5,9.0,9.5,10.0mm	

13件套直柄高速钢含Co麻花钻

13Pcs Hss-Co.5% Cobalt Stub Drills Set

- 优质HSS M35含钴5%高速钢材质，全磨制工艺加工，确保切削硬度及速度
- 刃口采用135度双后角工艺加工，保证定位准确
- Qualified HSS M35 steel (Co: 5%), fully milled, ensured hardness and cutting speed.
- Adopts 135 degree dual rear degree technology for cutting edge, making accurate positioning.



Item no.	
S133021	6
13件 公制直柄高速钢含Co麻花钻1.5,2.0,2.5,3.0, 3.2,3.5,4.0,4.5,4.8,5.0,5.5,6.0,6.5mm	

25件套直柄高速钢含Co麻花钻

25Pcs Hss-Co.5% Cobalt Stub Drills Set

- 优质HSS M35含钴5%高速钢材质，全磨制工艺加工，确保切削硬度及速度
- 刃口采用135度双后角工艺加工，保证定位准确
- Qualified HSS M35 steel (Co: 5%), fully milled, ensured hardness and cutting speed.
- Adopts 135 degree dual rear degree technology for cutting edge, making accurate positioning



Item no.	
S133023	6
25件 公制直柄高速钢含Co麻花钻1.0,1.5,2.0,2.5,3.0, 3.5,4.0,4.5,5.0,5.5,6.0,6.5,7.0,7.5,8.0,8.5,9.0,9.5,10.0,10.5,11,11.5,12,12.5,13.0mm	

 **SHEFFIELD**



管道类工具 **PIPE TOOLS**

切管类、弯管器、管钳
Tubing Cutter, Pipe Bender, Pipe Wrench

切管器

Tubing Cutter

- 刀片采用优质合金钢
- 适于切割铜、铝金属管，不适合切割钢管
- Induction hardened alloy steel cutter wheel
- Suit for cutting copper, aluminum tubes



Item no.	Size(mm)	
S100022	3-22	6
S100032	3-32	6
S100045	6-45	6
S100063	14-63	6

2片装切管器轮片

Tubing Cutter Replacement Wheel

- 刀片采用优质合金钢，适于切割铜、铝金属管
- 每包2片，切割范围: 3-32mm
- Induction hardened alloy steel cutter wheel, Suitable for cutting copper, aluminum tubes
- Cutting range: 3-32mm, 2 wheels per pack



Item no.	Size(mm)	
S100101	3-32	24

2片装切管器轮片

Tubing Cutter Replacement Wheel

- 刀片采用优质合金钢，适于切割铜、铝金属管
- 每包2片，切割范围: 14-63mm
- Induction hardened alloy steel cutter wheel, Suitable for cutting copper, aluminum tubes
- Cutting range: 14-63mm, 2 wheels per pack



Item no.	Size(mm)	
S100102	14-63	24

PVC 管子割刀刀片

Pipe Cutter Replacement Wheel

- 刀片采用65Mn优质材料，经热处理
- Heat treated 65Mn steel blade



Item no.	Size(mm)	
S101101	42	12

PVC 管子割刀

Pipe Cutter

- 刀片采用65Mn优质材料，经热处理
- 能有效切割<42mm PVC管子
- Heat treated 65Mn steel blade
- Capacity: <42mm PVC tube



Item no.	Size(mm)	
S101001	42	6

三合一铝塑管专用弯管器

3-in-1 Pipe Bender

- 适用铝塑管的弯管作业
- 弯管范围: 0-135°
- 弯管能力(直径): 16mm, 20mm, 25mm
- Bending applications: plastic pipe
- Max Bending Radius (deg.) range : 0-135° degree
- Max. Bending Capacity - Round (In. dia.): 16mm, 20mm, 25mm



Item no.	Size	
S102000	0-90° (16mm, 20mm, 25mm)	1

180° 三合一弯管器

3-in-1 Pipe Bender

- 适用铜、铝管的弯管作业
- 弯管范围: 0-180°
- 弯管能力(直径): 6mm, 8mm, 10mm
- Bending applications: copper tubing, aluminum tubing, soft metal tubing
- Max Bending Radius (deg.) range : 0-180° degree
- Max. Bending Capacity - Round (In. dia.): 6mm, 8mm, 10mm



Item no.	Size	
S102002	0-180° (6mm, 8mm, 10mm)	1

弯管器

Tubing Bender

- 适用铜管, 铝管及其它软金属管
- 弯管范围: 0-180°
- Bending applications: copper tubing, aluminum tubing, soft metal tubing
- Max Bending Radius range : 0-180° degree



Item no.	Size(mm)	
S102006	6	1
S102008	8	1
S102010	10	1
S102012	12	1

不锈钢管弯管器

Heavy Duty Tubing Bender

- 碳钢锻造弯管盘, 坚固耐用
- 弯管范围0~180度
- Drop Forged Carbon steel
- Max bending radius range:0~180 degree



Item no.	最大弯曲外径	管壁厚度	
S102106	6mm	1mm以下	6
S102108	8mm	1mm以下	6
S102110	10mm	1.2mm以下	6
S102112	12mm	1.2mm以下	6

多功能强力型弯管器

Heavy Duty Tubing Bender

- 适用铜管, 铝管及其它软金属管
- 弯管范围: 0-135°
- Bending applications: copper tubing, aluminum tubing, soft metal tubing
- Max bending radius range : 0-135° degree



Item no.	Size(mm)	
S102022	16/22	1
S102025	19/25	1

扩管器

Pipe Expander

- 夹板和螺栓表面镀铬
- 支架采用优质钢材锻造热处理, 坚固耐用
- 中间丝杆和锥子经特别硬化处理,
- 适用铜、铝等金属管
- 适用管子外径: 5, 6, 8, 10, 11, 13, 16mm
- 符合美国标准GGG-G-451a, 6-13-68. Type 2, Class 2, Style A
- Chrome plated steel die bars and clamping screws
- Drop forged, heat-treated steel yoke
- Hardened, self-centering cone produces perfect 45 degree flares
- For soft copper, aluminum and brass tubing
- Tubing Outer Diameter: 5mm, 6mm, 8mm, 10mm, 11mm, 13mm, 16mm
- Meets or exceeds federal specifications GGG-G-451a, 6-13-68. Type 2, Class 2, Style A



Item no.	Size(mm)	
S103001	5-16	6

伸缩管钳

Pipe Wrench

- 活动钳口及固定钳口采用特殊材料精锻而成, 采用特殊热处理工艺, 抗冲击, 牙齿不打滑、耐磨性能好
- 钳体采用40Gr精铸而成, 套管及伸缩加力柄采用40Gr无缝钢管, 特殊热处理, 弹性好、不断裂
- 采用套管式伸缩加力柄, 能够根据扭矩大小选择力臂长度, 减轻操作者的劳动强度
- 伸缩加力柄设有定位卡簧, 伸缩时定位卡簧能清除加力拉杆的油泥
- 体积小、重量轻、扭矩大、强度高
- 夹紧性能好、使用寿命长。管钳牙齿夹紧性能好, 不打滑, 耐磨, 使用寿命长
- Adjustable and fixed jaws are made of special materials for precision forging form, using a special heat treatment process, impact-resistance, no teeth slipping, good resistance to abrasion
- Deep casted jaw with 40Gr, casing and telescopic loading handle with 40Gr seamless steel pipe, special heat treatment, good elasticity, unbreakable
- The use of telescopic retractable handles can be selected according to torque arm length, reduce operator's labor intensity
- The positioning clamp spring can help to remove the sludge on loading lever
- Small and lightweight, high torque, high strength
- Good clamping performance and longer service life. Pipe wrench teeth with premium clamping performance, without skidding, abrasion-resistance, longer service life

新品

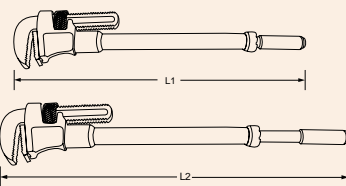

Item no.	Size	L1(mm)	L2(mm)	
S104218	18"	465	620	2
S104224	24"	520	695	2
S104236	36"	645	965	2
S104248	48"	780	1135	2

管钳

Pipe Wrench

- 手柄采用球墨铸铁, 经久耐用
- 活动钳头采用优质铬钼钢
- 钳头可以更换
- 符合美国GGG-651标准
- Sturdy, cast iron handle
- Drop forged Cr-Mo steel hook jaw
- Replaceable hook and heel jaws
- Meets or exceeds Federal specification GGG-651

CR-MO



Item no.	Size	L(mm)	
S104006	6"	150	6
S104008	8"	200	6
S104010	10"	250	6
S104012	12"	300	6
S104014	14"	350	6
S104018	18"	450	2
S104024	24"	600	1
S104036	36"	900	1
S104048	48"	1200	1

铝合金管钳

Aluminum Pipe Wrench

- 铝合金手柄, 经久耐用
- 活动钳头采用优质铬钼钢
- 钳头可以更换
- 符合美国GGG-651标准
- Lightweight aluminum handle
- Drop forged Cr-Mo steel hook jaw
- Replaceable hook and heel jaws
- Meets or exceeds Federal specification GGG-651

CR-MO



Item no.	Size	L(mm)	
S104110	10"	250	6
S104112	12"	300	6
S104114	14"	350	6
S104118	18"	450	2
S104124	24"	600	2
S104136	36"	900	1
S104148	48"	1200	1

链条扳手

Chain Wrench

- 优质钢材, 整体锻造
- 机磨加工, 表面镀铬处理
- Quality steel & drop forged
- Chrome plated



Item no.	Size	Capacity(mm)	
S112009	15"	60-135	6
S112010	12"	55-105	12



汽保机修专用工具



汽保机修专用工具 **AUTOMOTIVE TOOLS**

组套工具、润滑工具、引擎维修、底盘/传动维修、
制冷维修工具、轮胎维护、车身维修、通用工具

Tool set, Grease, Engine, Pick up tool, Refrigeration Tool, Tyre Repair, Bodywork Maintain Tool

120+1件套汽保专用维修组套

121Pc Tool Set

- 采用优质铬钒钢 • Chrome-Vanadium steel
- 表面镀铬，镜面抛光处理 • Chrome plated, mirror polished

CR-V



Item no.

S110001



1

- 10件 6.3mm系列公制六角标准套筒：
4, 5, 6, 7, 8, 9, 10, 11, 12, 13mm
- 4件 6.3mm系列公制六角长套筒：8, 9, 10, 12, mm
- 11件 10mm系列公制六角标准套筒：9, 10, 11, 12, 13, 14, 15, 16, 17, 18, 19mm
- 4件 10mm系列公制六角长套筒：13, 14, 15, 17mm
- 8件 10mm系列花形套筒：
E8, E10, E11, E12, E14, E16, E18, E20
- 7件 12.5mm系列公制六角套筒：
20, 21, 22, 24, 27, 30, 32mm
- 2件 10mm系列火花塞套筒16, 21mm
- 7件 10mm系列花型旋具套筒：
T20, T30, T40, T45, T50, T55, T60
- 4件 10mm系列六角旋具套筒：H3, H4, H5, H6
- 4件 10mm系列十字旋具套筒：PH1, PH2
- 2件 10mm系列公制一字型旋具套筒：5.5, 6.5mm
- 1件 6.3mm系列梨型头快速脱落胶柄棘轮扳手
- 1件 10mm系列梨型头快速脱落胶柄棘轮扳手
- 1件 12.5mm系列梨型头快速脱落胶柄棘轮扳手
- 1件 6.3mm系列万向接头
- 1件 10mm系列万向接头
- 1件 12.5mm系列万向接头
- 1件 10mm系列大小接头10 x 6.3mm
- 1件 10mm系列三用接头10 x 12.5mm (带孔)
- 1件 6.3mm系列接杆2"
- 2件 10mm系列接杆3", 6"
- 2件 12.5mm系列接杆5", 10"
- 1件 6.3mm系列旋柄
- 1件 6.3mm系列起子变换头
- 1件 12.5mm系列L型套筒扳杆
- 3件 6.3mm系列25mm长一字旋具头 4, 5, 6.5mm
- 3件 6.3mm系列25mm长十字旋具头PH1, PH2, PH3
- 8件 6.3mm系列25mm长中孔花型旋具头：
T8, T10, T15, T20, T25, T27, T30, T40
- 12件 公制精抛光两用扳手：
7, 8, 9, 10, 11, 12, 13, 14, 16, 17, 18, 19mm
- 9件 公制公制加长内六角扳手：
1.5, 2, 2.5, 3, 4, 5, 6, 8, 10mm
- 2件 通体螺丝刀：一字：6 x 100mm，
十字：PH2 x 100mm
- 1件 T52气缸盖螺丝专用套筒
- 1件 三爪扁脚滤清器扳手
- 1件 汽车测电笔
- 2件 8"鲤鱼钳，6"尖嘴钳

65件套轮胎维修组套

65Pc Tool Set

- 采用优质铬钒钢 • Chrome-Vanadium steel
- 表面镀铬，镜面抛光处理 • Chrome plated, mirror polished



Item no.

S110002



1

- 14件 公制精抛光两用长扳手8、9、10、11、12、13、14、15、16、17、18、19、22、24mm
- 15件 12.5mm系列公制六角标准套筒8、9、10、11、12、13、14、15、16、17、18、19、21、22、24mm
- 5件 12.5mm系列公制六角长套筒10、13、17、19、22mm
- 1件 12.5mm系列梨形头快速脱落胶柄棘轮扳手
- 1件 12.5mm系列万向接头68.5mm
- 1件 12.5mm系列接杆5"
- 1件 12.5mm系列接杆10"
- 1件 10mm系列三用接头10x12.5mm (带孔)
- 9件 9件套L型花型扳手T10、T15、T20、T25、T27、T30、T40、T45、T50
- 9件 9件套公制加长内六角扳手1.5、2、2.5、3、4、5、6、8、10mm
- 1件 美式穴用曲口卡簧钳5"
- 1件 数显轮胎花纹深度尺
- 1件 管钳10"
- 1件 卷尺5m
- 1件 10"活扳手
- 1件 机械游标卡尺150mm
- 1件 18mm塑柄美工刀
- 1件 轮胎平衡钳

奥迪系防盗螺丝专用套筒组套

Sleeve set for Audi series anti-theft screw

- 主要用于拆卸奥迪系轮胎防盗螺丝
- 采用CR-MO材质，表面镀铬处理
- 驱动套筒外壳采用ABS塑料材质，有效避免损伤轮毂表面
- Special for Audi series anti-theft screw
- CR-MO material & surface chromed
- ABS sleeve outer skin, protect wheel hub from scratch



Item no.

S113056

Size

21PC



3

专业级重型手用黄油枪 Heavy Duty Grease Gun with Hose

- 高强度耐压锌合金压铸头，高强度钢材枪身，耐油防滑护套，安全，耐用。
- 合金材料排气阀，方便排气。
- 适合在狭窄空间使用，手柄在没有完全张开的情况下也可方便注油。
- 特有设计，具有多种加油方式，正常状态下使用散装油，如需加注筒装油，须将手柄拆下，将筒内的橡皮塞边翻过来即可。
- 特有设计，拉杆可以带动橡胶活塞同时移动，有利于排除筒体内的空气，当您旋转90度，活塞与拉杆脱离。
- 适用3种注油方式：筒装油、密封油罐、散装油。
- 高强度热处理弹簧可保证灌注时压力持久均衡。
- 特来自锁装置使得灌注安全、方便。
- 油嘴特殊设计增加钢球自锁装置，确保工作中油不回流。
- 油枪的最大耐压可达700KG/cm²。
- Great in the industrial setting as well as in the home shop
- 3-Way loading: bulk, filler nipple or cartridge
- Heavy duty cast head construction for maximum durability and longer service life
- Bleeder valve for purging unwanted air
- 4-Jaw coupler for better grip and longer service life
- Durable follower rod and spring for consistent priming
- Non-slip knurled barrel for better grip
- Ergonomic lever grip

高强度耐压锌合金压铸头，合金材料排气阀，安全、耐用。

Cast head for durability
12,000 psi Air bleeder valve



油嘴特殊设计，增加钢球自锁，确保油不回流。
4-Jaw coupler for better grip and longer service life

特有设计，拉杆可以带动橡胶活塞同时移动，有利于排空枪体空气
Durable follower rod and spring for consistent priming

专业级手用黄油枪

Grease Gun

- 油枪最大耐压：10000PSI
- 灰色电着油桶，耐磨损，使用寿命更长
- 泄气嘴和自锁式设计，输油更方便
- 可使用标准14盎司筒装黄油、密封油罐、400cc散装油
- 适用于：汽车、卡车、轮船、割草机、压路机及拖拉机等机械设备
- Working pressure: 10000PSI
- Gray electric coating finish for service life
- Air vent head cap & positive lock for easy loading
- Use standard 14 Oz grease cartridge, dispenser loading, 400cc bulk loading
- Applications: cars, trucks, steamboats, grass cutters, tractors and other equipments



Item no.	Size	Working Pressure	
S111001	400CC	10000PSI	1

专业级手用黄油枪

Grease Gun

- 油枪最大耐压：2900PSI
- 灰色电着油桶，耐磨损，使用寿命长
- 泄气嘴和自锁式设计，输油更方便
- 适用于：汽车、卡车、轮船、挖掘机、压路机及起重机等机械设备
- Working pressure: 2900PSI
- Gray electric coating finish for service life
- Air vent head cap & positive lock for easy loading
- Applications: cars, trucks, steamboats, grass cutters, tractors and other equipments



Item no.	Size	Working Pressure	
S111004	120cc	2900PSI	1

手用黄油枪软管

Flexible Grease Gun Hose with Spring

- 适用于所有黄油枪
- 重型高强度黄油枪软管
- 工作耐压：4500PSI
- Fits all standard hand operated grease guns
- Heavy duty flexible nylon hose
- Operating pressure :4500PSI



Item no.	Size	L(mm)	
S111013	18"	450	10

专业级重型手用黄油枪

Heavy Duty Grease Gun with Hose

- 油枪最大耐压：12000PSI
- 灰色电着油桶，耐磨损，使用寿命更长
- 泄气嘴和自锁式设计，输油更方便
- 可使用标准14盎司筒装黄油、密封油罐、400cc散装油
- 适用于：汽车、卡车、轮船、割草机、压路机及拖拉机等机械设备
- Working pressure: 12000PSI
- Gray electric coating finish for service life
- Air vent head cap & positive lock for easy loading
- Use standard 14 oz grease cartridge, dispenser loading, 400cc bulk loading
- Applications: cars, trucks, steamboats, grass cutters, tractors and other equipments



Item no.	Size	Working Pressure	
S111002	400CC	12000PSI	1

手用黄油枪尖油嘴

Long Nose Grease Coupler

- 工作耐压：12000PSI
- Operating pressure :12000PSI



Item no.	L(mm)	
S111010	25	20

手用黄油枪油嘴

Grease Coupler

- 六边形4爪接口
- 特殊设计结构，确保工作中油不回流
- 工作耐压：12000PSI
- 4 Jaw hexagonal coupler
- Built-in ball check prevents leak and lubricant backup
- Operating pressure :12000PSI

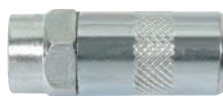

Item no.	L(mm)	
S111011	37	20

专业级重型手用黄油枪

Heavy Duty Grease Gun with Hose

- 油枪最大耐压：12000PSI
- 灰色电着油桶，耐磨损，使用寿命更长
- 泄气嘴和自锁式设计，输油更方便
- 可配备14oz筒装黄油，密封油罐，600CC散装黄油
- 适用于：汽车、卡车、轮船、挖掘机、压路机及起重机等机械设备
- Working pressure: 12000PSI
- Gray electric coating finish for service life
- Air vent head cap & positive lock for easy loading
- Use standard 14 oz grease cartridge, dispenser loading, 600cc bulk loading
- Applications: cars, trucks, steamboats, grass cutters, tractors and other equipments



Item no.	Size	Working Pressure	
S111003	600CC	12000PSI	1

手用黄油枪软管

Flexible Grease Gun Hose

- 适用于所有黄油枪
- 重型高强度黄油枪软管
- 工作耐压：4500PSI
- Fits all standard hand operated grease guns
- Heavy duty flexible nylon hose
- Operating pressure :4500PSI



Item no.	Size	L(mm)	
S111012	12"	250	10

2只装筒装黄油

2Pc Lithium Grease

- 优质锂基黄油
- 具有优良的抗磨挤压性能
- 具有优良的抗水性
- 具有优良的粘附性，保护金属不致磨损和腐蚀
- 具有优良的耐高温性，在高温下仍有较长的寿命
- 适用温度：-20 ~120
- 适用范围：各种机械设备的润滑
- Heavy-duty, lithium-based grease
- Excellent mechanical stability
- Water resistant
- Rust and oxidation inhibitors
- Long storage life under high temperature
- Working temperature range: -20°C~120°C
- For most automotive and industrial applications



Item no.	Size	L(mm)	
S111014	400cc	235	10

油壶

Oiler

- 特殊结构设计，省力耐用
- 壶身采用优质钢材加工，软性金属枪管，方便各种角度及空间使用。
- 软管两端采用铜接头制造，管内增加强力橡胶，强力耐压
- Trigger pump for easy operation
- High quality rust resistant steel construction
- Flexible metal spout for those hard to reach areas
- With durable brass pump for long reliable use.



Item no.	Size	
S111015	60Z	1

皮带式机油滤清器扳手

Strap Oil Filter Wrench

- 双层帆布夹尼龙皮带
- 快速拆卸各种汽车机油滤清器
- 手柄舒适防滑, 确保作业安全
- 适用尺寸: 30-160mm
- Strong nylon belt double layer
- Adjusts quickly to any spin-on filter
- Comfort grip handle
- For use with filters 30-160mm



Item no.	Size	L(mm)	
S112001	9"	225	6

三爪扁脚滤清器扳手

Three-Legged Spin-On Style Oil Filter Wrench

- 用于拆卸63-102mm 的滤清器
- 可用1/2" 方头驱动
- Fits 2-1/2" to 4" filters
- 1/2" square drive



Item no.	Size	
S112003	1/2"	6

活塞环压缩器

Piston Ring Compressor

- 采用优质弹簧钢高强度处理, 配有棘轮带锁装置
- 适用范围: 53-175mm
- Ratcheting lock mechanism with fingertip release lever
- For compressing rings on pistons 53-175mm in diameter



Item no.	Size	Capacity	
S112006	3"	Ø53-125mm	6
S112007	4"	Ø90-175mm	6

12.5mm系列套筒链式滤清器扳手

12.5mm Socket Chain Filter Wrench Series

- 套筒采用优质合金钢材质锻造, 整体热处理
- 加强型双排重型链条, 表面发黑处理
- 最大适用范围120mm
- Socket forged by high-grade alloy steel, heat-treated
- Reinforced dual chains, blackening treatment.
- Operating size:120mm

新品



Item no.	Size(mm)	
S113044	120	6

气门油封钳

Valve Stem Seal Removal Pliers

- 采用优质钢材, 整体热处理
- 手柄握持舒适
- 用于汽车气门油封和气门弹簧的拆卸
- Ideal for removing the valve stem seals
- Heat-treated steel
- Comfort grip handle



Item no.	Size	L(mm)	
S112004	10"	250	6

手铐式滤清器扳手

Oil Filter Wrench

- 优质合金钢材质, 雾面镀铬处理
- 软性沾塑手柄, 握持舒适
- High grade alloy steel, Matte chrome plated
- Double-dipped handle for comfortable & firm grip



Item no.	Size(mm)	
S112011	55-75	6
S112012	75-95	6

汽缸铲刀

Extended Scraper

- 用于清除汽车发动机缸体内部的积碳和油污, 也用于调温泵、曲轴箱等密封工件的表面清理
- 使用优质合金钢锻造
- 加长设计, 方便使用
- Removes carbon and old gasket materials from engine parts
- Holds standard single edge blade
- Extended handle



Item no.	Size	L(mm)	
S112002	10"	265	6

钳式机滤扳手

Oil Filter Pliers

- 用于拆卸 63.5 - 116mm 之间的滤清器
- 钳头带齿, 夹持不打滑
- 手柄握持舒适
- 63.5mm to 116mm adjustable for most filters
- Sure grip teeth prevent slipping
- Comfortable grip handle



Item no.	Size	L(mm)	
S112005	11"	290	6

14件套碗型机滤扳手

14PC Cup Type Oil Filter Wrench Set

- 优质钢材, 整体锻造加工, 表面镀铬处理
- 加强型驱动方榫, 更加耐用
- Forged steel, chrome plated
- Reinforced driving tenon for more durability

升级



Item no.	Size	
S112021	14pc	1

适用车型:

- 14P/65mm:适用于TOYOTA,NISSION,HONDA,GEELY
- 14P/67mm:适用于FORD,MITSUBISHI,MAZDZ,HYUNDAI,KIA,BYD,HAIMA,HAFEI
- 14P/72.5mm:适用于TOYOTA
- 14P/74mm:适用于BENZ,BMW,AUDI,VW,PEL,HYUNDAI,KIA
- 14P/84mm:适用于BENZ,OMG42
- 15P/74mm:适用于VW,AUDI
- 15P/76mm:适用于FORD,MAZDA
- 15P/79mm:适用于MITSUBISHI,HONDA,NISSION,TOYOTA
- 15P/82mm:适用于HYUNDAI,KIA
- 16P/87mm:适用于VOLVO,BMW
- 12P/76mm:适用于PEUGEOT,CITROEN,RENAULT
- 18P/86mm:适用于PEUGEOT,CITROEN,RENAULT,BYD
- 30P/75mm:适用于FORD,MAZDA
- 36P/93mm:适用于FORD,MAZDA

1.5"榉木双夹铲刀

1.5 "double blade beech

- 刀片材料420不锈钢
- 表面镜面抛光处理
- Blade material 420 stainless steel
- Mirror polishing

新品



Item no.	Size	
S112014	1.5"	6

滤清器大力钳

Filter Wrench

- 优质钢材整体锻造加工, 整体热处理
- 适用范围: 53 - 108mm
- Forged by high-grade alloy steel, heat-treated
- Operating range:53~108mm



Item no.	Size(mm)	
S113045	53~108	12

整套工具、润滑油工具、引擎维修、底盘/传动维修、制动维修工具、轮胎维护、车身维修、通用工具



8"气门钳

8" Valve Pincers

- 采用优质合金钢材质，整体锻造，雾面电镀处理
- 高级橡塑手柄，握持舒适，耐用
- 适用于OHV发动机，适用范围：75 ~ 165mm
- Forged alloyed steel, satin finish
- Soft plastic handle for comfortable grip and durability
- Fits OHV engine, scope: 75-165mm



Item no.	Size	
S112013	8"	6

两爪、三爪拉马多用套装

2/3 Jaw Gear Puller

- 2爪、3爪可以转换使用
- 拉爪采用优质铬钒钢锻造，表面镀铬处理
- 顶杆经过特殊热处理，经久耐用
- 拉爪可以双向使用
- 适用于拆除轴承、齿轮等
- 2 or 3 jaw gear puller
- Drop forged chrome-vanadium steel jaw, chrome plated
- Heat-treated center screw for durability
- Inside and outside reversible jaw
- Pulls gears, bearings, pulleys, steering wheels, etc.



Item no.	Size	Capacity(mm)	Minimum load(kn)	
S113000	6"	25-160	25.72	6

大众车前减拆装套筒

Front Shock Absorber Remover/Installer

- 采用优质铬钒钢锻造
- 表面镀铬
- 适用于拆装大众系列汽车的前减震器
- Drop forged chrome-vanadium steel
- Chrome plated
- For VW and Audi FWD cars front shock absorber



Item no.	Capacity	
S113022	桑车前减震器	6

碗型机滤扳手

bowl shaped filter wrench

- 优质钢材，整体锻造加工，表面镀铬处理
- 加强型驱动方榫，更加耐用
- Forged steel, chrome plated
- Reinforced driving tenon for more durability

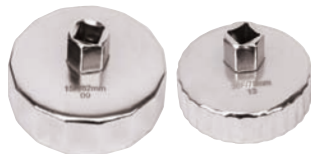

Item no.	Size(mm)	
S112022	14P/65-64	6
S112023	14P/67-66	6
S112024	14P/74-73	6
S112025	14P/73-72	6
S112026	15P/74	6
S112027	15P/79-78	6
S112028	15P/80-79	6
S112029	15P/89-88	6
S112030	15P/91-90	6
S112031	15P/92-91	6
S112032	15P/102	6
S112033	12P/80	6
S112034	18P/77	6
S112035	18P/86	6

适用车型：

- 14P/65mm:适用于 TOYOTA,NISSION,HONDA,GEELY
- 14P/67mm:适用于 FORD,MITSUBISHI,MAZDZ,HYUNDAI, KIA,BYD,HAIMA,HAFEI
- 14P/72.5mm:适用于TOYOTA
- 14P/74mm:适用于 BENZ,BMW,AUDI,VW,PEL,HYUNDAI,KIA
- 14P/84mm:适用于BENZ,OMG42
- 15P/74mm:适用于VW,AUDI
- 15P/76mm:适用于FORD,MAZDA
- 15P/79mm:适用于MITSUBISHI,HONDA,NISSION,TOYOTA
- 15P/82mm:适用于HYUNDAI,KIA
- 16P/87mm:适用于VOLVO,BMW
- 12P/76mm:适用于 PEUGEOT,CITROEN,RENAULT
- 18P/86mm:适用于 PEUGEOT,CITROEN,RENAULT,BYD
- 30P/75mm:适用于FORD,MAZDA
- 36P/93mm:适用于FORD,MAZDA

2爪双向拉马

2 Jaw Gear Puller

- 拉爪采用优质铬钒钢锻造，表面镀铬处理
- 顶杆经过特殊热处理，经久耐用
- 拉爪可以双向使用
- 适用于拆除轴承、齿轮等
- Drop forged chrome-vanadium steel jaw, chrome plated
- Heat-treated center screw for durability
- 2 different pulling ways: external or internal
- Pulls gears, bearings, pulleys, steering wheels, etc.



Item no.	Size	Capacity(mm)	Minimum load(kn)	
S113010	3"	15-80	15.68	12
S113011	4"	20-110	25.72	6
S113012	6"	25-160	44.45	1
S113013	8"	30-210	80.02	1
S113014	10"	30-260	80.02	1
S113015	12"	50-310	126.0	1

大众车后减拆装套筒

Rear Shock Absorber Remover/Installer

- 采用优质铬钒钢锻造
- 表面镀铬
- 适用于拆装大众系列汽车的后减震器
- Drop forged chrome-vanadium steel
- Chrome plated
- For VW and Audi FWD cars back shock absorber



Item no.	Capacity	
S113023	桑车后减震器	6

3爪双向拉马

3 Jaw Gear Puller

- 拉爪采用优质铬钒钢锻造，表面镀铬处理
- 顶杆经过特殊热处理，经久耐用
- 拉爪可以双向使用
- 适用于拆除轴承、齿轮等
- Drop forged chrome-vanadium steel jaw, chrome plated
- Heat-treated center screw for durability
- Inside and outside reversible jaw
- Pulls gears, bearings, pulleys, steering wheels, etc.



Item no.	Size	Capacity(mm)	Minimum load(kn)	
S113016	3"	15-80	15.68	12
S113017	4"	20-110	25.72	6
S113018	6"	25-160	44.45	1
S113019	8"	30-210	80.02	1
S113020	10"	30-260	80.02	1
S113021	12"	50-310	126.0	1

减震器拆装专用套筒

Shock Absorber Remover/Installer

- 采用优质铬钒钢锻造
- 表面镀铬
- 适用于拆装大众系列汽车的前减震器
- Forged chrome-vanadium steel
- Chrome plated
- For VW and Audi FWD cars front shock absorber



Item no.	Capacity	
S113024	减震器	6

连杆臂球头拉拔器
Pitman Arm Puller

- 采用优质钢材锻造，整体热处理，拉脚更耐用
- 中间丝杆特殊加硬处理
- 专业拆卸汽车连接臂接头
- Drop forged, heat treated steel yoke
- Hardened and tempered, precision-machined center screw
- Removes pitman arms on most cars and light trucks



Item no.	Size(mm)	Depth(mm)	
S113025	28	55	6
S113026	33	64	6

轮胎平衡钳
Wheel Weight Pliers

- 采用优质钢材锻造，表面镀铬
- 用于拆装汽车轮毂的平衡块，可用于敲击、剪切
- 手柄握持舒适
- Drop-forged steel, chrome plated
- Easily removes and replace wheel weight
- Comfortable dipped grip handle



Item no.	L(mm)	
S113027	240	6

碟式刹车调整器
Disc-brake Spreaders

- 优质合金钢整体锻造
- 适用于双活塞浮动式卡钳及四活塞固定式卡钳，可安全快捷的将活塞环压入卡钳闸壳。
- Whole piece forged alloy steel
- Suitable for double-piston floating caliper



Item no.	Size	
S113028	10"	6

卷型弹簧压缩器
Drop Forged Coil Spring Compressor

- 整体CR-V锻造加工，高强度，使用寿命长
- 1/2"驱动方孔，可配合1/2"驱动工具或21mm套筒、扳手使用
- Whole piece forged chrome vanadium steel for high intensive and long life usage
- Fits 1/2" Dr. tools or 21mm sockets, wrenches.



Item no.	Size(mm)	
S113029	370	6

日式球头取出器
Ball Joint Separator

- 可用于大多数轿车及轻型卡车的横杆球头的拆卸
- 开口范围: 19mm
- Use to replace worn out ball joints on most cars and light trucks
- Jaw open: 19mm



Item no.	Size(mm)	L(mm)	
S113030	19	160	6

欧式球头取出器
Ball Joint Separator

- 可用于大多数轿车及轻型卡车的横杆球头的拆卸
- 开口范围: 22mm
- Use to replace worn out ball joints on most cars and light trucks
- Jaw open: 22mm



Item no.	Size(mm)	L(mm)	
S113031	22	160	6

球头拉拔器
Ball Joint Separator

- 可用于大多数轿车及轻型卡车的横杆球头的拆卸
- 开口范围: 17mm
- Use to replace worn out ball joints on most cars and light trucks
- Jaw open: 17mm



Item no.	Size(mm)	L(mm)	
S113032	17	260	6

轴承拆卸器
Bearing Separator

- 用于拆卸轴承
- 拉力: 5吨
- Professional gear & bearing separator
- Capacity: 5 Ton

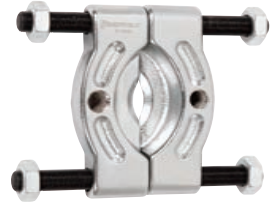

Item no.	Size	Capacity	
S113033	2"	Ø30-50	6
S113034	3"	Ø50-75	6

轴承分离器套装30~75mm
Bearing Separator And Puller Set 30-75mm

- 适用于拆卸普通轴承，方向盘轴承，皮带盘轴承
- 拆卸范围: 30~75mm
- Fits for demounting of normal bearing, steering wheel bearing, etc.
- demount scope: 30-75mm



Item no.	Size(mm)	
S113035	30-75	1

- 1件 小盘培令 (30~50mm)
- 1件 中盘培令 (50~75mm)
- 4件 主杆，对边六角直径: 17mm
- 4件 副杆，对边六角直径: 14mm
- 1件 扁担
- 1件 中心顶杆: 9/16"XL175mm

7件套冷媒管油管接头拆装组套
7Pc Cool Oil Pipe Disassembly

- 用于快速拆卸空调管路和油路
- 规格包括: 1/4", 5/16", 3/8", 1/2", 5/8", 3/4", 7/8"
- Easily disconnects air conditioning lines & quick connect fuel lines
- Includes sizes: 1/4", 5/16", 3/8", 1/2", 5/8", 3/4", 7/8"



Item no.	Size	
S113036	7pc	12



正时皮带盘拆装拉马

Pulley Puller

- 用于拆卸曲轴正时皮带盘
- 使用范围：40~90mm，适用于任何车型
- 拉爪长度100mm，宽22mm
- 整体CR-V锻造加工，雾面镀铬处理
- Range:40-90mm, use for any vehicle
- Come with two 100mm long, 22mm width jaws



Item no.	Size(mm)	
S113038	40-90	6

奥迪专用油底壳螺丝拆装套筒M16

M16 Special Socket For AUDI Series

- 整体CR-V锻造加工，雾面镀铬处理
- 主要用于奥迪汽车油底壳拆卸，安装
- Whole piece forged chrome-vanadium steel, satin finish
- fit for demounting and installation of crankcase oil tray for Audi series



Item no.	Size	
S113039	M16	12

指针式公斤扳手

Beam Torque Wrench

- 整体采用铬钒钢加工，表面雾面镀铬处理，美观坚固耐用
- 软性TPR手柄，指性外观结构，握持舒适。
- 最大可使用扭力范围300N.m。
- Chrome vanadium steel, chrome plated
- Palm soft TPR handle for comfort
- Max.torque:300N.m



Item no.	Size	
S113040	300N.m	1

1/2"系列带式滤清器扳手

Oil Filter Strap Wrench

- 采用优质尼龙带，结实耐用。
- 适用于1/2"DR.驱动工具或13/16"的旋柄，可拆卸直径120mm之内的滤清器
- Strong wide nylon belt for a strong, no-slip grip
- Fits spin-on type filters up to 120mm(4-3/4") in diameter
- Operated with a 1/2" Sq. Drive & 13/16" spinner handle



Item no.	Size	
S113042	18"	12

T52气缸盖螺丝专用套筒

Long Star Socket

- 用于拆卸大众系捷达、桑塔纳气缸盖螺丝
- Used for the cylinder head bolts, applicable to Jetta and Santana on VW serial.

S2



Item no.	Size	
S113043	T52	12

T型万向火花塞套筒

Extended Flex Spark Plug Socket

- 优质铬钒钢整体锻造加工，表面镀铬处理
- 连接杆头部特有方榫结构，可轻松配备棘轮扳手使用
- 套筒头部增加磁，方便使用
- Forged chrome vanadium steel, chrome plated
- Square tenon construction fit for ratchet wrenches
- With magnet in the head of socket for convenient use

CR-V

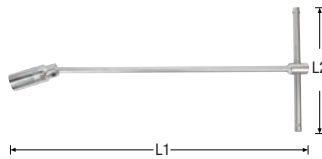

Item no.	Size(mm)	L1(mm)	L2(mm)	
S113051	16	445	200	6
S113052	21	445	200	6

10mm系列12角薄壁火花塞套筒

10mm Drive 12PT Spark Plug Socket

- 采用优质铬钒钢材质
- 表面镀铬，镜面抛光处理
- Chrome-Vanadium steel
- Chrome plated, mirror polished

新品



Item no.	Size(mm)	
S011415	14	12

11" 火花塞专用钳

11" Spark Plug Pliers

- 采用CR-NI材质，整体锻造处理
- 孔径15mm，总长度280mm
- 用于拆卸圆形物件，并适用于拆装火花塞
- High quality CR-NI steel .Body forged treatment
- aperture:15mm,overall length:280mm
- Used for removing the circular object and mainly designed for spark plug



Item no.	Size	
S112008	11"	6

5PC挑钩组合

5Pc Hook and Pick Set

- 采用优质合金钢加工，整体热处理，表面镀铬处理，美观耐用
- 主要用于挑拉O形圈，密封垫，开口销等，轻松便捷
- Forged quality alloy steel for durability
- Entire heat-treated, chrome plated
- Ideal for picking up 'O'ring,sealed ring,cotter pin and more.



Item no.	Size	
S113041	5pc	12

12件刹车分泵调整组套

12PC Universal Caliper Wind Back Kit

- 主要用于调节制动泵，以更换刹车片
- 采用优质材料精密加工，保证使用中螺纹顺滑
- Mainly used for adjusting brake pump for changing brake pad
- Qualified steel under precision machining, guarantee the smooth of screw during usage



Item no.	Size	
S113055	12pc	6

枪式充气表

Gun Type Compressed Air Meter

- 锌合金压铸枪体，专业级表盘，优质橡塑护套，确保使用精度
- 度数范围：0~16bar(0~220psi)
- Zinc alloy body, professional dial plate, plastic cover, ensured accuracy
- degree scope: 0-16bar(0-220psi)

⚠️ 操作时请注意勿跌落,勿阳光暴晒
Please note that do not fall during operation.
Do not exposure to sunlight.

升级



Item no.	Size	
S114011	220psi	6

数显轮纹深度尺

Digital Tread Depth Gauge

- 金属测量头，经久耐用
- 三按键设计LCD，具有电源控制，任意位置归零及公英制转换
- 适合测量轮胎花纹，制动蹄片磨损
- Metal measuring head
- Large LCD display
- Zero setting at any position
- Metric/Inch system interchange
- Manual power on/off
- Suitable for tread depth, brake shoe and pad wear

新品

送电池



Item no.	Range(mm)	Resolution(mm)	
S117023	0-25	0.01	12

墩形钣金衬铁

Mound Shaped Sheet Metal Lining Iron

- 高碳钢锻造成型，整体淬火加工处理，强度更高
- 耐敲击镜面抛光处理
- high carbon forged, whole quenched, higher strength
- mirror polished, anti knock



Item no.	Size	
S116002	墩形	6

手持式数显充气表

Digital Inflator Gauge

- 内置高精度传感器，精确读数
- 测气、充气、排气三功能（建议连接气源操作）
- 防摔缓冲TPE材质护套
- 充气高流量Max: 900L/分钟
- 独特截气反冲测压设计
- 自动省电模式
- 三种单位读数 BAR、PSI、kPa
- Built-in high precision sensor, accurate readings
- Three functions—gas measurement, gas charging and air exhaust (recommended operation is connecting gas source)
- Shatter-resistant TPE material buffer sheath
- Inflatable high flow Max: 900L/min
- A unique pressure measurement design of recoil pressure
- Auto power-saving mode
- Three unit readings, BAR, PSI and kPa

⚠️ 操作时请注意勿跌落,勿阳光暴晒
Please note that do not fall during operation.
Do not exposure to sunlight.

新品



Item no.	Maximum current	
S114013	600A	1

汽车测电笔

Circuit Tester

- 测压范围：6V - 12V - 24V
- 绝缘鳄鱼夹
- 不锈钢尖探头
- 2个备用发光管
- 1个备用探针护罩
- 6-12-24Volt system
- Insulated alligator clip
- Super sharp probe
- 2 extra bulbs
- 1 Probe cap



Item no.	L(mm)	
S115001	140	10

弯形钣金衬铁

Curve Sheet Metal Lining Iron

- 高碳钢锻造成型，整体淬火加工处理，强度更高
- 耐敲击镜面抛光处理
- high carbon forged, whole quenched, higher strength
- mirror polished, anti knock



Item no.	Size	
S116003	弯形	6

轮纹深度尺

Tread Depth Gauge

- 轻薄小巧，操作轻松，携带方便
- 适合测量轮胎花纹磨损，教学辅导使用
- Light and small, easy handle
- Suitable for measuring tread depth wear

新品



Item no.	Range	Resolution	
S117022	0~20mm	1mm	48

7件套钣金组套

7Pcs Auto Body Repair Kit



Item no.	Size	
S116001	7pc	1

1件	弯形钣金衬铁	1 Pc	Curved Dolly
1件	扁形钣金衬铁	1 Pc	Heel Dolly
1件	轻式缩减钣金锤	1 Pc	Bumping Hammer
1件	鹤嘴精整钣金锤	1 Pc	Pick Hammer
1件	直面精整钣金锤	1 Pc	Body Hammer
1件	墩型钣金衬铁	1 Pc	Combination Dolly
1件	铲型钣金衬铁	1 Pc	Spoon Dolly

扁形钣金衬铁

Flat Sheet Metal Lining Iron

- 高碳钢锻造成型，整体淬火加工处理，强度更高
- 耐敲击镜面抛光处理
- high carbon forged, whole quenched, higher strength
- mirror polished, anti knock



Item no.	Size	
S116004	扁形	6



铲形钣金衬铁

Shovel Shaped Sheet Metal Lining Iron

- 高碳钢锻造成型，整体淬火加工处理，强度更高
- 耐敲击镜面抛光处理
- high carbon forged, whole quenched, higher strength
- mirror polished, anti knock



Item no.	Size	
S116005	铲形	6

鹤嘴精整钣金锤

Pickaxe Shaped Delicate Sheet Metal Hammer

- 锤头高碳钢锻造成型，整体淬火加工处理，强度更高
- 外形依据整形钣金工序需求加工而成，保证敲击面受力均匀
- 手柄采用硬木柄材质，干燥性及弹性俱佳。特殊嵌入工艺确保锤头不易脱落
- high carbon forged steel hammer, whole quenched, higher strength
- contour base on the demand of sheet metal, stress evenly
- american walnut hand, dry & elastic, special embedding technology for hammer



Item no.	Size	L(mm)	
S116008	206G	330	6

3件套伸缩轮胎扳手

3Pc Wheel Master Wrench Set

- 套筒采用优质铬钒钢锻造
- 手柄采用优质钢材制造，表面镀铬
- 手柄伸缩范围355-530mm
- 手柄握持舒适，适于使力
- 适用于轿车、清卡轮胎的拆装
- 2个双头套筒规格：17mm x 19mm; 21mm x 23mm
- Chrome vanadium steel socket
- Chrome plated carbon steel body
- Telescopic handle extends 355 to 530mm
- Ergonomic comfort grip handle
- Fits most car and light truck wheel nuts
- 2 Dual size sockets: 17mm(11/16")x19mm(3/4"); 21mm(13/16")x23mm(7/8")



Item no.	Size	
S117003	1/2"x(355-530mm), 17x19mm, 21x23mm	3

轻式缩减钣金锤

Light type cut sheet metal hammer

- 锤头高碳钢锻造成型，整体淬火加工处理，强度更高
- 外形依据整形钣金工序需求加工而成，保证敲击面受力均匀
- 手柄采用硬木柄材质，干燥性及弹性俱佳。特殊嵌入工艺确保锤头不易脱落
- high carbon forged steel hammer, whole quenched, higher strength
- contour base on the demand of sheet metal, stress evenly
- american walnut hand, dry & elastic, special embedding technology for hammer



Item no.	Size	L(mm)	
S116006	320G	330	6

5件套断丝取出器

5Pc Screw Extractor Set

- 采用优质合金钢
- 适于拆卸已损坏的大头钉、螺丝、螺栓等
- 螺纹设计获取强劲抓力
- Alloy steel
- Designed to remove broken studs, bolts, socket screws and fittings
- Aggressive left hand spiral design for extra gripping power



Item no.	Size(mm)	
S117001	3.3, 5.3, 6.4, 8.8, 11.2	6

伸缩轮胎扳手

Wheel Master Wrench

- 手柄采用优质钢材制造，表面镀铬
- 手柄伸缩范围355-530mm
- 手柄握持舒适，便于施力
- 适用于轿车、清卡轮胎的拆装
- Chrome plated carbon steel body
- Telescopic handle extends 355 to 530mm
- Ergonomic comfort grip handle
- Fits most car and light truck wheel nuts



Item no.	Size	
S117004	1/2"x(355-530mm)	6

直面精整钣金锤

Straight Delicate Sheet Metal Hammer

- 锤头高碳钢锻造成型，整体淬火加工处理，强度更高
- 外形依据整形钣金工序需求加工而成，保证敲击面受力均匀
- 手柄采用硬木柄材质，干燥性及弹性俱佳。特殊嵌入工艺确保锤头不易脱落
- high carbon forged steel hammer, whole quenched, higher strength
- contour base on the demand of sheet metal, stress evenly
- american walnut hand, dry & elastic, special embedding technology for hammer



Item no.	Size	L(mm)	
S116007	305G	330	6

十字轮胎扳手

Lug Wrench

- 采用优质铬钒钢锻造，表面全抛镀铬
- 十字形状在操作中能更好地提供扭力
- 3头为6角套筒：17mm, 19mm, 21mm；另一头为1/2"驱动方头
- Drop forged chrome-vanadium steel
- Fully polished and chrome plated
- Cross design provides extra leverage and torque
- 6pt. Metric lug wrench size: 17mm, 19mm, 21mm & 1/2" drive

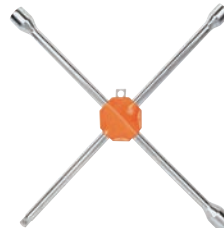

Item no.	Size	L(mm)	
S117002	1/2"方头, 17, 19, 21mm	18"	3
S116009	1/2"方头, 17, 19, 21mm	20"	3

磁性伸缩式捡拾器

Magnetic Pick Up Tool

- 不锈钢可伸缩天线
- 活动头设计，拾取更灵活
- 磁力强劲
- 最大可伸展尺寸：650mm
- Stainless steel antenna
- Multi-angle ball joint neck
- Powerful magnet
- Extends up to 650mm



Item no.	Size	L(mm)	
S117005	6"	650	6

可弯式磁性捡拾器

Flexible Magnetic Pick Up Tool

- 磁力强劲
- 450mm长可弯曲软质管材，柔韧性好
- 可以通过任意角度在狭小空间拾取掉落的铁制紧固件
- Powerful magnet
- 18"(457.2mm) flexible shaft holds any angle
- Great for picking up iron or steel fasteners that fall into tight spaces



Item no.	Size	L(mm)	
S117006	23"	450	6
S117024	16"	450	6

方型磁力盘

Rectangle Magnetic Parts Tray

- 采用不锈钢材料
- 适合存放螺丝、螺帽及其它铁制小工具
- 磁力强劲，都能保证盘内物品不掉落
- Stainless steel
- Ideal for storage of nuts, bolts, small tools, and other items
- powerful magnet



Item no.	Size(mm)	
S117009	240x140	6

塑胶风枪

Air Blow Gun

- 风枪喷嘴长250mm，手柄舒适
- 易于精确控制风力和风向
- 适用于各种机械和仪器的除尘
- 工作压力：0-8公斤
- 6mm 进气接头
- Air blow gun with 10° angled nozzle and comfort grip handle
- Allows for precise control of air flow and direction
- Fast way to air-clean equipment and machinery of all kinds
- Recommended working air pressure is 0-120 PSI
- 1/4" NPT. fitting

升级



Item no.	Size	
S117012	10"	6

胶扣起子

Plastic Fastener Remover

- 快速拆除胶扣
- 操作时不损伤汽车表面
- Quickly remove various types of plastic fasteners
- Protect vehicle surface



Item no.	Size	
S117007	9"	6

3件套刷子

3Pc Wire Brush

- 用于清洁汽车零部件表面及细缝
- 1件尼龙刷
- 1件钢丝刷
- 1件铜丝刷
- Lightweight polycast handle
- 1-pc. nylon bristle brush
- 1-pc. brass bristle brush
- 1-pc. stainless steel bristle brush



Item no.	Size	
S117010	7"	6

铝合金风枪

Air Duster

- 铝合金压铸本体
- 双进气口
- 更换不同长度风嘴，调整风量
- 适用于清除碎屑、粉末、水滴、冷却、干燥
- Aluminum alloy die-casting body
- Dual inlet
- Adjust the air volume by changing different length of the air nozzle
- Applies to remove debris, powder, water, cooling and drying

新品



Item no.	Size	
S117020	1"	6

圆形磁力盘

Round Magnetic Parts Tray

- 采用不锈钢材料
- 适合存放螺丝、螺帽及其它铁制小工具
- 磁力强劲，都能保证盘内物品不掉落
- Stainless steel
- Ideal for storage of nuts, bolts, small tools, and other items
- powerful magnet



Item no.	Size(mm)	
S117008	Ø150	6

塑胶风枪

Air Blow Gun

- 风枪喷嘴长100mm，手柄舒适
- 易于精确控制风力和风向
- 适用于各种机械和仪器的除尘
- 工作压力：0-8公斤
- 6mm 进气接头
- Air blow gun with 4° angled nozzle and comfort grip handle
- Allows for precise control of air flow and direction
- Fast way to air-clean equipment and machinery of all kinds
- Recommended working air pressure is 0-120 PSI
- 1/4" NPT. fitting

升级



Item no.	Size	
S117011	4"	6

5件套伸缩检测镜

5Pc Pick Up Tool with Inspection Mirror Set

- 1个手柄；2个检测镜；1个带LED灯磁性头；1个活动头
- 最大可伸展尺寸：710mm
- 1 handle; 2 Mirrors; Led magnetic head; Multi-angle ball joint neck
- Extends up to 710mm



Item no.	Size	L(mm)	
S117013	7"	710	6



带灯圆形伸缩检测镜

Telescoping Inspection Mirror with LED Light

- 采用1个 3mm LED
- 圆镜直径32mm
- 不锈钢可伸缩天线
- 活动头设计, 拾取更灵活, 可以通过任意角度在狭小空间作业
- 最大可伸展尺寸: 910mm
- 1PC Ø3mm LED
- 1-1/4" Round Mirror
- Stainless steel antenna
- Multi-angle ball joint neck
- Extends up to 910mm



Item no.	Size	L(mm)	
S117014	9.5"	910	6

带灯铝合金磁性伸缩式捡拾器

Magnetic Pick Up Tool

- 头部有LED灯, 方便在黑暗环境下作业
- 铝合金壳体, 不锈钢可伸缩天线
- 活动头设计, 拾取更灵活, 可以通过任意角度在狭小空间作业
- 磁力强劲, 持久
- 最大可伸展尺寸: 690mm
- Easily retrieves objects in dark areas
- Lightweight aluminum body, stainless steel antenna
- Multi-angle ball joint neck
- Powerful magnet
- Extends up to 690mm



Item no.	Size	L(mm)	
S117017	7-3/16"	690	6

柔性带灯磁性四爪捡拾器

Lighted Claw Pickup Tool

- 铝合金壳体, 氧化处理表面, 美观耐腐蚀
- 400mm长可弯曲弹簧软管, 柔韧性好, 方便任意角度和狭小空间工作
- 头部特有LED灯珠, 方便在黑暗环境下作业
- 四爪结构设计, 特有强磁功能, 方便操作, 使用灵活
- lighted 4-claw magnetic pickup tool
- Anodized aluminum housing for longer life
- 400mm flexible shaft perfect for retrieving in confined spaces
- LED light illuminates dark areas
- Four strong claws & magnet design for positive grabbing

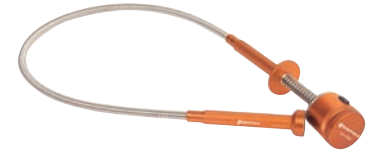

Item no.	Size	
S117021	24"	6

带灯伸缩检测镜

Telescoping Inspection Mirror with LED Light

- 采用1个 5mm LED
- 圆镜直径55mm
- 不锈钢可伸缩天线
- 活动头设计, 拾取更灵活, 可以通过任意角度在狭小空间作业
- 最大可伸展尺寸: 940mm
- 1PC Ø5mm LED
- 2-1/4" Round Mirror
- Stainless steel antenna
- Multi-angle ball joint neck
- Extends up to 940mm



Item no.	Size	L(mm)	
S117015	11"	910	6

带灯磁性伸缩式捡拾器

Magnetic Pick Up Tool

- 头部有LED灯, 方便在黑暗环境下作业
- 不锈钢可伸缩天线
- 可弯曲软质管材, 柔韧性好, 可以通过任意角度在狭小空间作业
- 最大可伸展尺寸: 650mm
- Easily retrieves objects in dark areas
- Stainless steel antenna
- Powerful magnet
- Extends up to 650mm



Item no.	Size	L(mm)	
S117018	9"	650	6

40" 支架式修车板

40" Adjustable Headrest Creeper

- 躺板头部可进行调整, 舒适方便
- 6个承重万向脚轮, 快速省力
- 整理承重强, 粉末喷涂工艺
- 40" Steel Frame With A Molded Polyurethane Dadded Bed
- Multiposition Head Rest For Comfort
- 6 Extra Wide Ball Bearing Castors For Fast, Effortless Movement In Any Direction
- Heavy Duct Construction, Powder Coated Finish



Item no.	Size	
S113058	40"	1

带灯伸缩检测镜

Telescoping Inspection Mirror with LED Light

- 采用3个 5mm LED
- 圆镜直径82mm
- 不锈钢可伸缩天线
- 活动头设计, 拾取更灵活, 可以通过任意角度在狭小空间作业
- 最大可伸展尺寸: 760mm
- 3PC Ø5mm LED
- 3-1/4" Round Mirror
- Stainless steel antenna
- Multi-angle ball joint neck
- Extends up to 760mm



Item no.	Size	L(mm)	
S117016	12"	760	6

塑料铆钉专用拆卸钳

Clip Removal Pliers

- 优质合金钢整体锻造, 双色沾塑手柄, 握持舒适, 耐用
- 适用于汽车面板、车身与其他部分固定螺钉的拔取, 也可用于其他工业应用上的塑料螺栓的拔取
- Forged alloyed steel, dual dipping handle for comfort grip and durability
- Unplugging fired screws on Auto panel, loady and other parts of the car



Item no.	Size	
S117019	10"	6

36" 塑料修车板

36" 6-Wheel Plastic Creeper

- 优质橡塑材质, 更大承重能力
- 6个承重万向尼龙脚轮, 快速省力
- 适用范围: 专业、工业、汽修或家用
- Super-rugged, Low-profile Creeper
- 6 Extra Ball Bearing Nylon Castors For Fast, Effortless Movement In any direction
- For Professional, Industrial, Automotive Or Home Use



Item no.	Size	
S113059	36"	1



SHEFFIELD



起重类工具 **HOIST TOOLS**

立式千斤顶、卧式千斤顶
Hydraulic Bottle Jacks, Garage Jack

立式液压千斤顶

Hydraulic Bottle Jacks

- 采用优质钢材加工，确保额定载重吨位，使用安全
- 活塞环及泵芯表面特殊处理，保证耐用性，增加抗腐蚀能力
- 抓手采用优质铸钢材质，提供更高使用强度
- 特有增加安全阀保护结构，当使用超过额定载重吨位1.15倍以上时，安全阀将开启，承载泵芯不再上升，保证使用安全
- 采用低温液压油，工作使用温度：-30°C~60°C

- With high quality steel, Powerful jacks make big loads easy to lift and Rated Capacity keep it is safety Used
- Special processing for piston rings and pump to ensure durable performance and enforce resistant to corrosion
- With high quality cast steel for handle, Greater strength
- Safety valve built, which will open when used to 1.5 times the Rated Capacity that help stabilize the load a safer lift
- Temperature ranging from -30°C-60°C

⚠使用时，回油阀锁紧扣旋松角度请勿超过90°



Item no.	Capacity	Minimum Height(mm)	Lift Height(mm)	Adjust Height(mm)	Max Height(mm)	N.W(kg)
S160011	2T	158	90	60	308	2.3
S160012	3T	195	125	60	380	3.3
S160013	5T	197	125	60	382	4.4
S160014	8T	205	125	60	390	5.4

立式液压千斤顶

Hydraulic Bottle Jacks

- 采用优质钢材加工，确保额定载重吨位，使用安全
- 活塞环及泵芯表面特殊处理，保证耐用性，增加抗腐蚀能力
- 抓手采用优质铸钢材质，提供更高使用强度
- 特有增加安全阀保护结构，当使用超过额定载重吨位1.15倍以上时，安全阀将开启，承载泵芯不再上升，保证使用安全
- 采用低温液压油，工作使用温度：-30°C~60°C

- With high quality steel, Powerful jacks make big loads easy to lift and Rated Capacity keep it is safety Used
- Special processing for piston rings and pump to ensure durable performance and enforce resistant to corrosion
- With high quality cast steel for handle, Greater strength
- Safety valve built, which will open when used to 1.5 times the Rated Capacity that help stabilize the load a safer lift
- Temperature ranging from -30°C-60°C

⚠使用时，回油阀锁紧扣旋松角度请勿超过90°



Item no.	Capacity	Minimum Height(mm)	Lift Height(mm)	Adjust Height(mm)	Max Height(mm)	N.W(kg)
S160017	15T	225	140	60	425	8.5
S160018	20T	244	145	60	449	11.5

立式液压千斤顶

Hydraulic Bottle Jacks

- 采用优质钢材加工，确保额定载重吨位，使用安全
- 活塞环及泵芯表面特殊处理，保证耐用性，增加抗腐蚀能力
- 抓手采用优质铸钢材质，提供更高使用强度
- 特有增加安全阀保护结构，当使用超过额定载重吨位1.15倍以上时，安全阀将开启，承载泵芯不再上升，保证使用安全
- 采用低温液压油，工作使用温度：-30°C~60°C

- With high quality steel, powerful jacks make big loads easy to lift and Rated Capacity keep it is safety Used
- Special processing for piston rings and pump to ensure durable performance and enforce resistant to corrosion
- With high quality cast steel for handle, greater strength
- Safety valve built, which will open when used to 1.15 times the Rated Capacity that help stabilize the load a safer lift
- Temperature ranging from -30°C-60°C

⚠使用时，回油阀锁紧扣旋松角度请勿超过90°



Item no.	Capacity	Minimum Height(mm)	Lift Height(mm)	Adjust Height(mm)	Max Height(mm)	N.W(kg)
S160015	10T	205	125	60	390	6
S160016	12T	215	125	60	400	7.2

卧式低位液压千斤顶3.5T

3.5T Garage Jack

- 采用优质钢材加工，确保额定载重吨位，使用安全
- 超低位设计，适用车型广，可起升底盘较低轿车
- 双泵油压提升结构，起升快速
- With high quality steel, Powerful jacks make big loads easy to lift and Rated Capacity keep it is safety Used
- Applicable to lifting Automotive, vehicles and so on with good performance
- "Low profile" models are perfect for "close quarters" lifting, faster and powerful which offer heavy duty performance



Item no.	Capacity	Minimum Height(mm)	Max L*W*H(mm) Height(mm)	N.W(kg)
S160021	3.5T	95	552 790X335X180	44

重型卧式液压千斤顶3T

3T Garage Jack

- 采用优质钢材加工，确保额定载重吨位，使用安全
- 双泵油压提升结构，起升快速
- With high quality steel, Powerful jacks make big loads easy to lift and Rated Capacity keep it is safety Used
- "Low profile" models are perfect for "close quarters" lifting, faster and powerful which offer heavy duty performance



Item no.	Capacity	Minimum Height(mm)	Max L*W*H(mm) Height(mm)	N.W(kg)
S160022	3T	133	465 682X344X155	30.5

卧式低位液压千斤顶2.5T

2.5T Garage Jack

- 采用优质钢材加工，确保额定载重吨位，使用安全
- 超低位设计，适用车型广，可起升底盘较低轿车
- With high quality steel, Powerful jacks make big loads easy to lift and Rated Capacity keep it is safety Used
- Applicable to lifting Automotive, vehicles and so on with good performance



Item no.	Capacity	Minimum Height(mm)	Max L*W*H(mm) Height(mm)	N.W(kg)
S160023	2.5T	85	381 560X212X145	12.5

卧式低位液压千斤顶3T

3T Garage Jack

- 采用优质钢材加工，确保额定载重吨位，使用安全
- 超低位设计，可起升底盘较低汽车
- 双泵油压提升结构，起升快速
- 特有增加安全阀保护结构，使用超过1.15倍以上时，安全阀开启，承载泵芯不再上升，保证使用安全
- With high quality steel, Powerful jacks make big loads easy to lift and rated capacity keep it is safety used
- Applicable to lifting automotive, vehicles and so on with good performance
- "Low profile" models are perfect for "close quarters" lifting, faster and powerful which offer heavy duty performance
- Safety valve built, which will open used to 1.5 times the rated capacity that help stabilize the load a safer lift



Item no.	Capacity	Minimum Height(mm)	Max L*W*H(mm) Height(mm)	N.W(kg)
S160024	3T	75	505 780x385x165	31

起重葫芦系列 Hoist Series

新品

图一：手拉葫芦

货号	产品名称	起升重量 (T)	起升高度 (M)	起重链条		满载时的手拉力 (N)	净重 (KG)	尺寸 (MM)				
				行数	直径X节距 (MM)			A	B	C	D	H
●S200010	手拉葫芦 0.5T*3m	0.5	3.0	1	5X15	240	9.3	148	132	23	35	345
●S200011	手拉葫芦 0.5T*6m	0.5	6.0	1	5X15	240	13.6	148	132	23	35	345
S200020	手拉葫芦 1T*3m	1.0	3.0	1	6X18	250	12.3	172	151	26	40	376
S200021	手拉葫芦 1T*6m	1.0	6.0	1	6X18	250	16.7	172	151	26	40	376
●S200030	手拉葫芦 1.5T*3m	1.5	3.0	1	7X21	265	16.5	196	173	29.5	45	442
●S200031	手拉葫芦 1.5T*6m	1.5	6.0	1	7X21	265	22.0	196	173	29.5	45	442
S200040	手拉葫芦 2T*3m	2.0	3.0	1	8X24	335	19.5	210	175	34	50	470
S200041	手拉葫芦 2T*6m	2.0	6.0	1	8X24	335	26.5	210	175	34	50	470
S200050	手拉葫芦 3T*3m	3.0	3.0	1	10X30	372	26.4	255	205	37.5	55	580
S200051	手拉葫芦 3T*6M	3.0	6.0	1	10X30	372	32.8	255	205	37.5	55	580
S200060	手拉葫芦 5T*3m	5.0	3.0	2	10X30	380	43.0	280	189	41	65	690
S200061	手拉葫芦 5T*6m	5.0	6.0	2	10X30	380	55.0	280	189	41	65	690
●S200070	手拉葫芦 7.5T*3m	7.5	3.0	3	10X30	380	71.6	433	189	50	85	800
●S200071	手拉葫芦 7.5T*6m	7.5	6.0	3	10X30	380	90.0	433	189	50	85	800
●S200080	手拉葫芦 10T*3m	10.0	3.0	4	10X30	380	80.7	463	189	51	85	830
●S200081	手拉葫芦 10T*6m	10.0	6.0	4	10X30	380	98.0	463	189	51	85	830

图二：手扳葫芦

货号	产品名称	起升重量 (T)	起升高度 (M)	起重链条		满载时的手拉力 (N)	净重 (KG)	尺寸 (MM)				
				行数	直径X节距 (MM)			A	B	C	D	H
●S200110	手扳葫芦 0.5T*1.5m	0.5	1.5	1	5X15	248	5.5	143	86	118	253	31.5
●S200111	手扳葫芦 0.5T*3m	0.5	3.0	1	5X15	248	6.5	143	86	118	253	31.5
S200120	手扳葫芦 0.75T*1.5m	0.75	1.5	1	5.6X17	265	6.9	148	87	132	278	35.5
S200121	手扳葫芦 0.75T*3m	0.75	3.0	1	5.6X17	265	8.4	148	87	132	278	35.5
●S200130	手扳葫芦 1T*1.5m	1.0	1.5	1	6X18	270	7.9	153	90	140	278	37.5
●S200131	手扳葫芦 1T*3m	1.0	3.0	1	6X18	270	8.9	153	90	140	278	37.5
S200140	手扳葫芦 1.5T*1.5m	1.5	1.5	1	7X21	295	10.5	173	99	145	378	42.5
S200141	手扳葫芦 1.5T*3m	1.5	3.0	1	7X21	295	12.0	173	99	145	378	42.5
S200150	手扳葫芦 2T*1.5m	2.0	1.5	1	8X24	315	14.3	181	105	152	378	45.0
S200151	手扳葫芦 2T*3m	2.0	3.0	1	8X24	315	16.3	181	105	152	378	45.0
S200160	手扳葫芦 3T*1.5m	3.0	1.5	1	10X28	335	20.7	200	112	199	418	50.0
S200161	手扳葫芦 3T*3m	3.0	3.0	1	10X28	335	25.7	200	112	199	418	50.0
●S200170	手扳葫芦 6T*1.5m	6.0	1.5	2	10X28	360	28.0	200	112	230	418	53.0
●S200171	手扳葫芦 6T*3m	6.0	3.0	2	10X28	360	36.0	200	112	230	418	53.0
●S200180	手扳葫芦 9T*1.5m	9.0	1.5	3	10X28	380	49.0	200	112	338	418	67.0
●S200181	手扳葫芦 9T*3m	9.0	3.0	3	10X28	380	65.0	200	112	338	418	67.0

注：标“●”的为非常规库存产品，需要一定的交货期

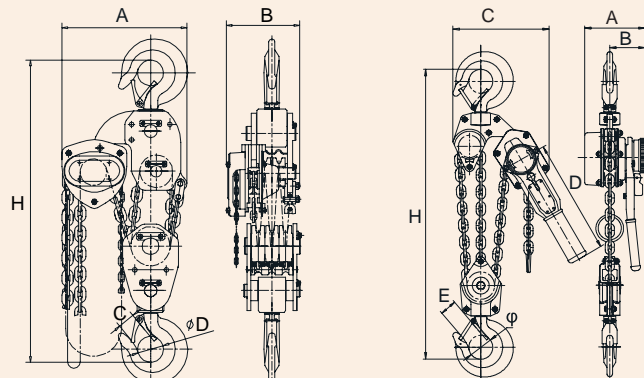

图一：手拉葫芦

图二：手扳葫芦

改良型转动齿轮，低合金钢精密加工，渗碳热处理工艺，齿轮硬度高，耐磨和防锈性能双提升

Improved rotary gear, alloy steel precision machining, carburizing and heat treated technology, high hardness of gear, wear-resistant and rust-proof.

外罩采用特殊卷边工艺，强度更高，链条滚动更顺滑。改良型传动系统，传动效率更高，运转更灵活

Housings with special crimping technology, higher strength, the chain is smoother. Improved transmission system brings more efficient transmission, more flexible operation.

三轴承结构取代钢套干磨 (2T以上)，传动效率更高，运转更灵活。特殊设计的三角花键长轴结构，中心轴能全部取出，便于清洁，彻底解决卡链问题。Specially designed long triangle spline shaft, central axis can be completely withdraw, easy to clean, completely solve the stuck chain problem.

上、下吊钩采用优质合金锻造成型，通过1.5倍超载试验，确保使用安全。Upper and lower hooks made of high quality forged alloy, pass the 1.3-1.5 times overload test to ensure safety.

对称式双棘爪制动系统，相比单棘爪制动，安全系数更高

The safety factor of symmetrical double pawl braking system increased more than single pawl braking system.

80级起重链条，达到国际高标准

Grade 80 lifting chain, to meet international standards.





SHEFFIELD

小型汽保设备 **AUTO EQUIPMENT**

引擎吊机、压机、立式运送顶、分离式千斤顶

Enging Crane, Hydraulic Press, Transmission Jack, Hydraulic Portable Body Repair Kits

引擎吊机

Engine Crane

- 吊臂可伸展,以适应不同需求
 - 重型设计,结构主体强度高,安全可靠
 - 折叠设计,可有效节省使用空间
 - 万向轮和直轮组合,移动灵活方便
 - 自锁紧回油阀,操作简便
 - 主要应用于汽车引擎修理时的吊装作业
- 注: 折叠腿壁厚3mm, 主吊臂厚3.5mm, 延伸臂厚3mm, 竖臂厚3.5mm
- Crane arm can be stretched to meet different needs
 - Heavy duty design, high intensity construction, safe and reliable
 - Folding design, efficient use of space
 - The combination of castors and wheels, flexible and convenient
 - Self-locking valve, easy operation
 - Mainly used in lifting operations of automotive engine repair
- Note: Folding leg thickness: 3mm; main crane thickness: 3.5mm extended arm thickness: 3mm; vertical arm thickness: 3.5mm
- 此产品为非常规库存产品, 需要一定的交货期

新品



货号	S160051
额载	2t
行程	1750mm
工作范围	25-2100mm
净重	80.2kg
毛重	88kg
包装尺寸	1520x590x305mm(木箱)
包装数量	1

变速箱运送千斤顶

Transmission Jack

- 双节油缸设计, 顶升高度高
 - 双油路快速泵, 工作效率高
 - 油缸密封件采用Y型聚氨酯材料, 使用寿命长
 - 主要用于汽车变速箱维修时的顶升作业
- Double-cylinder designs, jack lifting height is high
 - Dual-orifice fast pump, high efficiency
 - Cylinder seal part with Y-type polyurethane material, long service life
 - Mainly used in lifting operations of automotive gearbox repair
- 此产品为非常规库存产品, 需要一定的交货期

新品



货号	S160052
额载	0.5t
最低	870mm
最高	1795mm
净重	54kg
毛重	62kg
包装尺寸	520x230x800mm
包装数量	1

20T液压压力机

Hydraulic Shop Press

- 拼装式结构, 安装简便, 性能可靠
 - 配安全阀立顶, 杜绝超载使用, 从根本上提高产品的使用安全
 - 立柱及主体结构材料采用槽钢, 坚固耐用
 - 工作范围大, 保压性能好
 - 主要用于汽车维修时的钣金整形作业及轴承的拆装
- Mount structure, easy to install, reliable performance
 - Matching stand top of the relief valve to prevent overload, and fundamentally improve the safe use of the product
 - Column and the main structural material used steel for durability
 - Large working range and excellent holding pressure performance

● 此产品为非常规库存产品, 需要一定的交货期

新品

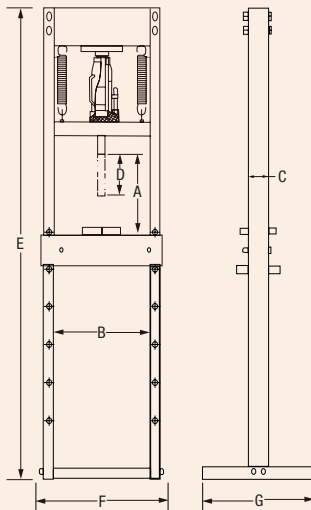

货号	S160053
额载	20t
工作范围	0-710mm
净重	68.3kg
毛重	71.8kg
包装尺寸	1530x205x220mm
A	0-710mm
B	465mm
C	100mm
D	150mm
E	1500mm
F	640mm
G	540mm

分离式千斤顶套装

Hydraulic Portable Body Repair Kits

- 高强度塑盒包装, 带滚轮外箱, 携带移动方便
 - 配多功能附件, 适用顶、劈、铲等各种作业
 - 快速接头设计, 操作简便
 - 高强度铸造件, 坚固耐用
 - 活塞杆密封件采用Y型聚氨酯材料, 使用寿命长;
 - 设计有手动排气孔, 方便调节长时间使用后油泵内部产生的气压
- High strength plastic box, with wheels outside the box, portable, easy to move
 - Equipped with multifunctional attachments, suitable for all kinds of jobs, such as support, split and shovel, etc
 - Quick connector design and easy operation
 - High strength casting, durable construction
 - Piston rod seal part with Y-type polyurethane material, long service life
 - Manual vent design, easy to adjust the pump pressure inside the oil pump after long time use
- 此产品为非常规库存产品, 需要一定的交货期

新品



货号	S160054
额载	10t
油缸行程	150mm
油缸最低高度	470mm
净重	27.5kg
毛重	35.5kg
包装尺寸	960x450x210mm
包装数量	1



综合测试实验室



静载测试机

引擎吊机、压机、立式运送顶、分离式千斤顶





SHEFFIELD



气动工具 **AIR TOOLS**

气动扳手、气动套筒及配件

Impact Wrench, Impact Socket and Accessories

3/8"复合材料气动扳手

3/8" Dr.Impact Wrench

- 双锤打击结构, 扭力强劲, 动力输出快速
- 复合材料外壳设计, 机身轻巧, 操作省力, 降低工作强度
- 握把排气设置, 配备消音装置, 减小工作噪音
- 三向进气钢制气缸, 扭力输出多出同类产品10%
- 单键正反切换, 多档气流调整控制
- Twin hammer mechanism, high torque, quick torque output
- Composite housing design, light body, easy operation, reducing workload
- handle exhaust design, reducing the sound pressure with a silencer
- Steel three-way-inlet cylinder, delivering extra 10% torque than similar products
- Forward/reversible regulator with different speeds



⚠ 每次使用前请加润滑油

产品货号	S125001
工作扭矩	379N.m
最大扭矩	475N.m
自由转速	1000R.P.M
平均耗气量	4CFM
进气口径	1/4"
进气管径	3/8"
工具总长	143MM
拧紧螺栓规格	M14
排气方式	握把排气
锤打结构	双锤打击
产品净重	1.33KG
包装数量	1

3/4"复合材料气动扳手

3/4" Dr.Impact Wrench

- 双锤打击结构, 扭力强劲, 动力输出快速
- 复合材料外壳设计, 机身轻巧, 操作省力, 降低工作强度
- 握把排气设置, 配备消音装置, 减小工作噪音
- 三向进气钢制气缸, 扭力输出多出同类产品10%
- 单键正反切换, 多档气流调整控制
- Twin hammer mechanism, high torque, quick torque output
- Composite housing design, light body, easy operation, reducing workload
- handle exhaust design, reducing the sound pressure with a silencer
- Steel three-way-inlet cylinder, delivering extra 10% torque than similar products
- Forward/reversible regulator with different speeds



⚠ 每次使用前请加润滑油

产品货号	S125004
工作扭矩	1626N.m
最大扭矩	1763N.m
自由转速	6500R.P.M
平均耗气量	6.7CFM
进气口径	3/8"
进气管径	1/2"
工具总长	225MM
拧紧螺栓规格	M25
排气方式	握把排气
锤打结构	双锤打击
产品净重	3.89KG
包装数量	1

1/2"复合材料气动扳手

1/2" Dr.Impact Wrench

- 双锤打击结构, 扭力强劲, 动力输出快速
- 复合材料外壳设计, 机身轻巧, 操作省力, 降低工作强度
- 握把排气设置, 配备消音装置, 减小工作噪音
- 三向进气钢制气缸, 扭力输出多出同类产品10%
- 单键正反切换, 多档气流调整控制
- Twin hammer mechanism, high torque, quick torque output
- Composite housing design, light body, easy operation, reducing workload
- handle exhaust design, reducing the sound pressure with a silencer
- Steel three-way-inlet cylinder, delivering extra 10% torque than similar products
- Forward/reversible regulator with different speeds



⚠ 每次使用前请加润滑油

产品货号	S125002
工作扭矩	813N.m
最大扭矩	949N.m
自由转速	8000R.P.M
平均耗气量	4.4CFM
进气口径	1/4"
进气管径	3/8"
工具总长	193MM
拧紧螺栓规格	M19
排气方式	握把排气
锤打结构	双锤打击
产品净重	2.15KG
包装数量	1

1/2"气动冲击扳手

1/2" Dr.Impact Wrench

- 圆形双锤打击结构, 动力输出快速, 金属外壳, 坚固耐用
- 特有增加气缸压迫装置, 有效保证工具运转的稳定性
- 杠杆式扳机设计, 快速回弹, 避免油污堵塞, 使用轻松, 寿命更长
- Round twin hammer Mechanism, quick torque output, metal casing, sturdy and durable
- specially added cylinder pressing device for stable operation
- lever trigger design, quick resilience, avoiding grease blockage for easy operation and long lifeuse



⚠ 每次使用前请加润滑油

产品货号:	S125003
工作扭矩:	570N.m
最大扭矩:	610N.m
自由转速:	7500R.P.M
平均耗气量:	7.2 SCFM
进气口径:	1/4"
进气管径:	3/8"
工具总长:	187MM
拧紧螺栓规格:	M16
排气方式:	前排气
锤打结构:	双锤打击
产品净重	2.62KG
包装数量	1

工业级气动扭力扳手

The Aerodynamic Torque Wrench

- 枪式气动马达与行星齿轮扭矩倍增器配合省力
- 气压三联件通过控制气压, 恒定输出扭矩
- 人体工学的枪式握把, 长时间工作不易疲劳
- 枪上端有悬挂杆, 大扭矩可用钢索类悬挂, 减轻工作强度
- 稳定气压下气动扭矩扳手重量精度 ± 5%
- 轮箱体与把手可作360度旋转, 反力臂反弹力不会传到操作者身上, 安全有保障
- Gun-type pneumatic motor with planetary torque multiplier coordination save labour
- Pneumatic FRL constantly output torque by controlling the air pressure
- Ergonomic pistol grip brings no easy feeling of fatigue during long working hours
- Pistol top with a fly rod, cable suspension is available for high torque, reducing the intensity of work
- Pneumatic torque wrench accuracy is ± 5% under stable pressure
- Gear box with handle can be rotated 360 degrees, reverse lever rebound does not spread to the operator, and assure perfect safety

⚠ 此产品为非常规库存产品, 需要一定的交货期

新品



产品货号	输出方榫	减速箱外径(mm)	外形尺寸 LxWxH(mm)	扭矩范围 (N.m)
S016231	3/4"	ø50	259x65x250	70-350
S016232	3/4"	ø59	272x75x252	160-800
S016233	3/4"	ø72	283x75x252	200-1000
S016234	1"	ø72	283x75x252	200-1000
S016235	1"	ø88	311x75x253	400-2000
S016236	1"	ø92	370x100x267	540-2700
S016237	1"	ø108-ø59	400x108x270	800-4000
S016238	1-1/2"	ø108-ø59	400x108x270	1000-5000
S016239	1-1/2"	ø126-ø59	488x100x264	1200-6000

产品货号	空载转速(rpm)	重量(kg)	最大气压(bar)	
S016231	42	3.1	6	1
S016232	30	4.3	6	1
S016233	20	5.7	6	1
S016234	20	5.7	6	1
S016235	15	8.8	6	1
S016236	11	9.3	6	1
S016237	11	12	6	1
S016238	11	12	6	1
S016239	11	16	6	1



3/8"系列六角气动套筒

3/8"Dr.6PT Standard Impact Socket

- 采用优质CR-MO材质，整体冷锻加工制造
- 表面磷酸锰处理，耐腐蚀
- Body cold-forging process with high quality CR-MO
- Manganese phosphate surface treatment, anti-corrosion

CR-MO

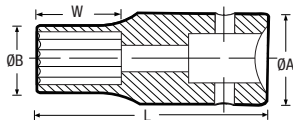

Item no.	Size(mm)	L(mm)	W(mm)	øA(mm)	øB(mm)	
S123007	7	28	12	18.8	12.1	12
S123008	8	28	12	18.8	13.5	12
S123009	9	28	12	18.8	14.5	12
S123010	10	28	12	18.8	15.8	12
S123011	11	30	14	18.8	17	12
S123012	12	30	14	18.8	18.2	12
S123013	13	30	14	21.8	19.5	12
S123014	14	30	14	21.8	20.8	12
S123015	15	30	14	21.8	21.8	12
S123016	16	30	10	22	23.8	12
S123017	17	32	10	22	23.8	12
S123018	18	32	10	22	25.8	12
S123019	19	32	10	22	27.7	12

3/8"系列气动接杆

3/8"Dr.Extention Bar

- 采用优质CR-MO材质，整体冷锻加工制造
- 表面磷酸锰处理，耐腐蚀
- Body cold-forging process with high quality CR-MO
- Manganese phosphate surface treatment, anti-corrosion

CR-MO

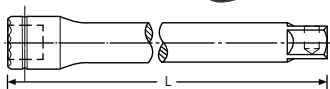

Item no.	Driver	Size(mm)	L(mm)	
S123001	3/8"	3"	75	12
S123002	3/8"	6"	150	12

1/2"系列六角气动套筒

1/2"Dr.6PT Standard Impact Socket

- 采用优质CR-MO材质，整体冷锻加工制造
- 表面磷酸锰处理，耐腐蚀
- Body cold-forging process with high quality CR-MO
- Manganese phosphate surface treatment, anti-corrosion

CR-MO

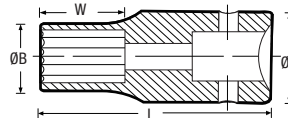

Item no.	Size(mm)	L(mm)	W(mm)	øA(mm)	øB(mm)	
S123210	10	38	18	23.8	17	12
S123211	11	38	18	23.8	18	12
S123212	12	38	18	23.8	19	12
S123213	13	38	18	23.8	20	12
S123214	14	38	18	23.8	22	12
S123215	15	38	18	23.8	23	12
S123216	16	38	18	23.8	23	12
S123217	17	38	18	25.8	23	12
S123218	18	38	18	25.8	23	12
S123219	19	38	18	27.8	23	12
S123221	21	38	18	29.8	23	12
S123222	22	38	14	30	31.8	12
S123223	23	38	14	30	31.8	12
S123224	24	38	14	30	33.8	12
S123227	27	42	14	30	37.8	12
S123230	30	43	12	30	41.8	12
S123232	32	43	12	30	43.8	12

3/8"系列气动万向接头

3/8"Dr.Universal Joint

- 采用优质CR-MO材质，整体冷锻加工制造
- 表面磷酸锰处理，耐腐蚀
- Body cold-forging process with high quality CR-MO
- Manganese phosphate surface treatment, anti-corrosion

CR-MO

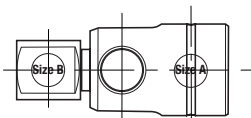

Item no.	SizeA	SizeB	
S123003	3/8"	3/8"	12

3/8"系列六角气动长套筒

3/8"Dr.6PT Deep Impact Socket

- 采用优质CR-MO材质，整体冷锻加工制造
- 表面磷酸锰处理，耐腐蚀
- Body cold-forging process with high quality CR-MO
- Manganese phosphate surface treatment, anti-corrosion

CR-MO

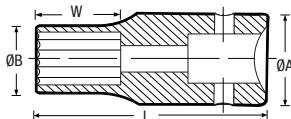

Item no.	Size(mm)	L(mm)	W(mm)	øA(mm)	øB(mm)	
S123108	8	63	35	18.8	13.5	12
S123109	9	63	35	18.8	14.5	12
S123110	10	63	35	18.8	15.8	12
S123111	11	63	35	18.8	17	12
S123112	12	63	35	18.8	18.2	12
S123113	13	63	35	21.8	19.5	12
S123114	14	63	35	21.8	20.8	12
S123115	15	63	35	21.8	20.8	12
S123116	16	63	10	22	23.8	12
S123117	17	63	10	22	23.8	12
S123118	18	63	10	22	25.8	12
S123119	19	63	10	22	27.7	12

3/8"系列气动接头

3/8"Dr.Universal Joint

- 采用优质CR-MO材质，整体冷锻加工制造
- 表面磷酸锰处理，耐腐蚀
- Body cold-forging process with high quality CR-MO
- Manganese phosphate surface treatment, anti-corrosion

CR-MO

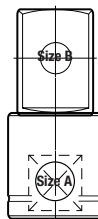

Item no.	SizeA	SizeB	
S123004	3/8"	1/4"	12
S123005	3/8"	1/2"	12

1/2"系列六角气动长套筒

1/2"Dr.6PT Deep Impact Socket

- 采用优质CR-MO材质，整体冷锻加工制造
- 表面磷酸锰处理，耐腐蚀
- Body cold-forging process with high quality CR-MO
- Manganese phosphate surface treatment, anti-corrosion

CR-MO

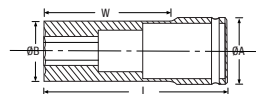

Item no.	Size(mm)	L(mm)	W(mm)	øA(mm)	øB(mm)	
S123310	10	78	54	23.8	17	12
S123311	11	78	54	23.8	18	12
S123312	12	78	54	23.8	19	12
S123313	13	78	54	23.8	20	12
S123314	14	78	54	23.8	22	12
S123315	15	78	54	23.8	23	12
S123316	16	78	54	23.8	23	12
S123317	17	78	54	25.8	23	12
S123318	18	78	54	25.8	23	12
S123319	19	78	54	27.8	23	12
S123321	21	78	54	29.8	23	12
S123322	22	78	14	30	31.8	12
S123324	24	78	14	30	33.8	12
S123327	27	78	14	30	37.8	12
S123330	30	78	12	30	41.8	12
S123332	32	78	12	30	43.8	12

1/2"系列气动接杆

1/2"Dr.Extention Bar

- 采用优质CR-MO材质，整体冷锻加工制造
- 表面磷酸锰处理，耐腐蚀
- Body cold-forging process with high quality CR-MO
- Manganese phosphate surface treatment, anti-corrosion

CR-MO



Item no.	Driver	Size(mm)	L(mm)	12
S123202	1/2"	5"	125	12
S123204	1/2"	10"	250	12

1/2"系列气动接头

1/2"Dr.Universal Joint

- 采用优质CR-MO材质，整体冷锻加工制造
- 表面磷酸锰处理，耐腐蚀
- Body cold-forging process with high quality CR-MO
- Manganese phosphate surface treatment, anti-corrosion

CR-MO

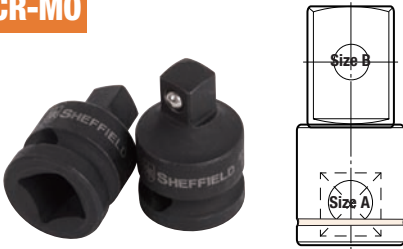

Item no.	SizeA	SizeB	12
S123207	1/2"	3/4"	12
S123208	1/2"	3/8"	12

1/2"系列气动万向接头

1/2"Dr.Universal Joint

- 采用优质CR-MO材质，整体冷锻加工制造
- 表面磷酸锰处理，耐腐蚀
- Body cold-forging process with high quality CR-MO
- Manganese phosphate surface treatment, anti-corrosion

CR-MO



Item no.	SizeA	SizeB	12
S123206	1/2"	1/2"	12

3/4"系列六角气动套筒

3/4"Dr.6PT Standard Impact Socket

- 采用优质CR-MO材质，整体冷锻加工制造
- 表面磷酸锰处理，耐腐蚀
- Body cold-forging process with high quality CR-MO
- Manganese phosphate surface treatment, anti-corrosion

CR-MO

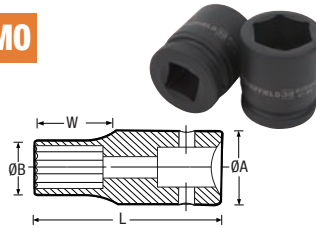

Item no.	Size(mm)	L(mm)	ØA(mm)	ØB(mm)	12
S123417	17	50	38	28.5	4
S123418	18	52	38	29.5	4
S123419	19	52	38	30	4
S123421	21	52	38	31	4
S123422	22	52	38	34	4
S123423	23	52	38	35	4
S123424	24	52	38	36	4
S123426	26	52	38	36	4
S123427	27	52	40	36	4
S123429	29	52	42	36	4
S123430	30	52	44	46	4
S123432	32	52	44	48	4
S123433	33	56	44	50	4
S123434	34	56	44	51	4
S123436	36	56	44	53.5	4
S123438	38	56	44	56	4
S123441	41	58	44	60	4
S123442	42	62	44	61	4
S123446	46	63	44	67	2
S123450	50	72	54	71	2
S123455	55	74	54	77	2
S123460	60	80	54	84	2
S123465	65	80	54	88	2

3/4"系列六角气动长套筒

3/4"Dr.6PT Deep Impact Socket

- 采用优质CR-MO材质，整体冷锻加工制造
- 表面磷酸锰处理，耐腐蚀
- Body cold-forging process with high quality CR-MO
- Manganese phosphate surface treatment, anti-corrosion

CR-MO

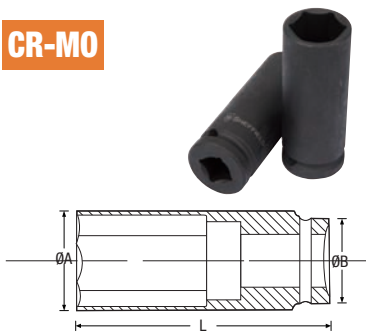

Item no.	Size(mm)	L(mm)	ØA(mm)	ØB(mm)	12
S123517	17	90	38	8.5	4
S123518	18	90	38	29.5	4
S123519	19	90	38	30	4
S123522	22	90	38	34	4
S123524	24	90	38	36	4
S123527	27	90	40	36	4
S123530	30	90	44	46	4
S123532	32	90	44	48	4
S123534	34	90	44	51	4
S123536	36	90	44	53.5	4
S123541	41	92	44	60	4
S123546	46	92	44	67	2
S123550	50	95	54	71	2
S123555	55	100	54	77	2

3/4"系列气动接杆

3/4"Dr.Extention Bar

- 采用优质CR-MO材质，整体冷锻加工制造
- 表面磷酸锰处理，耐腐蚀
- Body cold-forging process with high quality CR-MO
- Manganese phosphate surface treatment, anti-corrosion

CR-MO



Item no.	Driver	Size(mm)	L(mm)	12
S123402	3/4"	4"	100	6
S123405	3/4"	8"	200	2
S123406	3/4"	10"	250	2

3/4"系列气动接头

3/4"Dr.Universal Joint

- 采用优质CR-MO材质，整体冷锻加工制造
- 表面磷酸锰处理，耐腐蚀
- Body cold-forging process with high quality CR-MO
- Manganese phosphate surface treatment, anti-corrosion

CR-MO



Item no.	SizeA	SizeB	4
S123408	3/4"	1/2"	4

3/4"系列气动万向接头

3/4"Dr.Universal Joint

- 采用优质CR-MO材质，整体冷锻加工制造
- 表面磷酸锰处理，耐腐蚀
- Body cold-forging process with high quality CR-MO
- Manganese phosphate surface treatment, anti-corrosion

CR-MO



Item no.	SizeA	SizeB	4
S123407	3/4"	3/4"	4



个人
防护
用品



SHEFFIELD



个人防护用品 **SAFETY & SECURITY TOOLS**

耳塞、手套、口罩

Earplugs, Gloves, Masks

子弹型PU防噪音耳塞(不带线)
Bullet Shape Earplugs

- 子弹型轮廓设计, 降噪效果好
- 表面经特殊防污处理, 佩戴卫生安全
- 慢回弹, 耳道与耳塞贴合更紧密、舒适
- Bullet shape against harmful noise, especially in hot/humid conditions
- Earplugs are made of extra-soft, extra light foam, Easy to put on
- Slow rebound: 1 minute (regular), for a snug fit while gently conforming to the ear canal

新品

Item no.	Size(mm)	噪音降低率	
S180001	13x25	34dB	200

14"斜指焊接手套
14" Leather Welding Gloves

- 选用耐磨隔热牛二层皮制成
- 舒适吸汗绒里衬
- 斜拇指设计, 活动自然, 方便焊接和握持焊件
- 适合焊接, 切割等用
- Made of select A/AB grade leather feature heat and abrasion resistant
- Velvet lining for absorbing sweat and prevent slipping
- Wing thumb for durability and convenient handhold
- Perfect for welders, machine operators

新品

Item no.	Size(mm)	
S180021	14"	12

KN95折叠式颗粒物防护口罩
Disposable Safety KN95 Dust Mask

- 外置可调节软金属鼻夹保证鼻梁部分得到最佳密合
- 罩体按亚洲脸型立体裁剪, 佩戴舒适, 密闭性, 安全性高
- 焊接头带, 避免金属打钉对脸部的损伤
- 头戴式、耳戴式, 适应不同人群使用习惯
- 静电驻极纳米级喷熔过滤棉, 具备更高的孔隙率, 呼吸阻力小, 过滤效率高
- 防护对象: 颗粒物, 如矿物、煤、铁矿石、面粉和某些其他类似物质的粉尘颗粒物, PM2.5等
- 不适用: 有机蒸汽、油性颗粒物

- These masks have an adjustable nosepiece and secured headstraps to provide proper fit
- Masks are designed by the Asian face
- Welding fillet
- Head-wear, ear-wear can be choosed
- These masks made of electrostatic nano scale spray fused filter cotton
- Application: solids, such as those from minerals, coal, iron ore, flour and certain other substances. PM2.5
- Not applicable: organic vapor, oily particulate matter

新品

圣诞树型硅胶防噪音耳塞(带线)
4 Layers Christmas Tree Silicone Earplugs(With Code)

- 特殊表面四环设计, 确保与耳道的密合, 防噪效果好
- 优质硅胶制造, 可清洁和重复使用, 佩戴舒适
- 选配柔软细绳, 在不用时可方便的挂在脖子上, 防止丢失
- Conical earplugs (4 layers) for for ideal fit and optimized noise cancelling
- Silicone earplugs are made of extra-soft, lightweight silicone that seals the ear canal without pressure
- With cord, more convenient

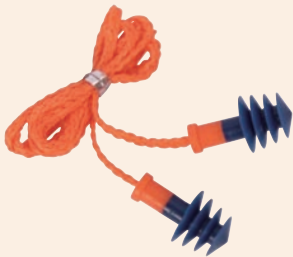
新品

Item no.	Size(mm)	噪音降低率	
S180003	15x25	25dB	100

10.5"经济型半皮全托手套
Leather Working Gloves

- 掌部采用耐磨, 防割牛皮
- 夹胶安全袖口, 加强手腕防护
- 背部斜纹布, 透气性好
- 适用于搬运, 铸造, 钢铁及机械操作使用
- Made of Split cowhide leather palm to encounter mechanical risk
- The rubberized safety cuffs offer wrist protection
- The jean back allows sweat vapor to escape
- Designed for low cost heavy duty use. Perfect for welders, porters and machine operators

新品

Item no.	Size(mm)	
S180022	10.5"	12

Item no.	Size(mm)	
S190001	耳戴式	50
S190002	头戴式	50



WORKPRO® 万克宝® 品牌简介

You can work professional

杭州巨星钢盾工具有限公司系国内五金工具行业上市企业杭州巨星科技股份有限公司（股票简称：巨星科技、股票代码：002444）的控股子公司，专业从事五金工具的研发、生产和销售。巨星科技是全球具有重要影响力的手工具产销企业，是多家全球500强零售企业在亚洲战略性手工具供应商，欧美众多工业用户的专业级工具供应商，在杭州经济技术开发区、杭州江干科技园区、海宁经济开发区等地有多个生产基地。

凭借上市积累的雄厚资本和在北美市场的强大张力，巨星科技于2010年9月底成功收购了美国Goldblatt Tool company, LLC; Finishpro tools, LLC; KC tools, LLC和KC holdings, LLC四家公司的相关资产，及其旗下的百年品牌Goldbla, SABERTOOTH和WORKPRO等11个专业手工具品牌。

WORKPRO品牌是行销美国和加拿大地区的知名手工具品牌，其产品贴近生活，坚实耐用，注重创新，引领潮流，有着鲜明的风格。特别是WORKPRO品牌从创立之初就始终践行环保无毒的理念，所用材料均通过铅，镉，汞等重金属和邻苯二甲酸盐（增塑剂）等有害物质含量检测，真正对消费者负责。

2013年7月，巨星科技成功将WORKPRO品牌引入中国市场，中文译名“万克宝”，致力于在国内推广欧美流行的DO IT YOURSELF（自己动手）理念，让人们在节省费用的同时，充分享受自己动手带来的乐趣。

还再调侃当代中国人的动手能力吗？

来吧！动起手来，有万克宝做您的左膀右臂，你完全可以！

有万克宝做您的左膀右臂
你完全可以！



17件套家用工具组套 / 货号：W1117



组件	件数	适用范围
双色柄钢丝钳6"	1件	门窗家具 水管龙头 安装拆卸 随车应急 设备检修 自行车维修
活扳手8"	1件	
铬钒钢螺丝刀一字6X100mm	1件	
铬钒钢螺丝刀十字PH2X100mm	1件	
钢卷尺3M	1件	
双色防滑柄羊角锤8OZ	1件	
小五金100PC	1件	
双色柄剪刀	1件	
公制内六角	8件	
手锯10"	1件	

20件套家用工具组套 / 货号：W1119



组件	件数	适用范围
双色柄尖嘴钳6"	1件	门窗家具 水管龙头 设备检修 家电检修 玩具维修 自行车维修
活扳手8"	1件	
铬钒钢螺丝刀一字6X100mm	1件	
铬钒钢螺丝刀十字PH2X100mm	1件	
钟表螺丝刀一字2.5X60mm	1件	
钟表螺丝刀十字PH0X60mm	1件	
钢卷尺3M	1件	
钢管柄羊角锤8OZ	1件	
小五金85PC	1件	
美工刀18mm	1件	
公制内六角	8件	
测电笔	1件	
绝缘胶带9M	1件	

房屋验收工具组套 / 货号：W1120



组件	件数	适用范围
双色防滑柄羊角锤8oz	1件	毛坯房和精装房的以下验收： 检测墙面和地面是否有空鼓 测量层高和面积是否与合同相符 检测地面和窗台是否水平 检测立柱以及墙面是否垂直 检测电路是否接通和安全 检测门和橱柜是否安装紧密牢固
多功能伸缩空鼓锤	1件	
双色包塑自锁卷尺5M	1件	
带磁水平尺9寸	1件	
铝座钢角尺6寸	1件	
数显测电笔	1件	
螺丝刀通用手柄	1件	
螺丝刀可换刀头	10件	
双色柄尖嘴钳6寸	1件	
美工刀18mm	1件	
铝合金手电筒6LED	1件	

25件套家用工具组套 / 货号：W1125



组件	件数	适用范围
三色柄螺丝刀一字6X100mm	1件	门窗家具 水管龙头 家用电器 手机数码 办公设备 物业维修
三色柄螺丝刀十字PH2X100mm	1件	
钟表螺丝刀一字1.8X60mm	1件	
钟表螺丝刀一字2.5X60mm	1件	
钟表螺丝刀十字PH00X60mm	1件	
钟表螺丝刀十字PH0X60mm	1件	
双色柄钢丝钳6"	1件	
活扳手8"	1件	
双色柄剪刀	1件	
双色包塑自锁卷尺3M	1件	
钢管柄羊角锤8OZ	1件	
小五金85PC	1件	
美工刀18mm	1件	
公制内六角	8件	
铝合金手电筒6LED	1件	
测电笔	1件	
绝缘胶带9M	1件	
手锯10"	1件	

39件套高级家用工具组套 / 货号：W1139



组件	件数	适用范围
三色柄螺丝刀一字6X100mm	1件	门窗家具 水管龙头 家用电器 手机数码 设备检修 物业维修
三色柄螺丝刀十字PH2X100mm	1件	
钟表螺丝刀一字1.8X60mm	1件	
钟表螺丝刀一字2.5X60mm	1件	
钟表螺丝刀十字PH00X60mm	1件	
钟表螺丝刀十字PH0X60mm	1件	
双色柄钢丝钳6"	1件	
三色套柄活扳手8"	1件	
6.3mm系列旋柄	1件	
批头	10件	
双色柄多功能厨房剪	1件	
双色包塑自锁卷尺3M	1件	
双色防滑柄羊角锤8OZ	1件	
小五金85PC	1件	
双色包塑美工刀18mm	1件	
公制内六角	11件	
铝合金手电筒6LED	1件	
数显测电笔	1件	
绝缘胶带9M	1件	
手锯10"	1件	

50件套高级家用工具组套 / 货号：W1150



组件	件数	适用范围
三色柄螺丝刀一字6X100mm	1件	门窗家具 水管龙头 家用电器 手机数码 设备检修 物业维修
三色柄螺丝刀十字PH2X100mm	1件	
钟表螺丝刀一字1.8X60mm	1件	
钟表螺丝刀一字2.5X60mm	1件	
钟表螺丝刀十字PH00X60mm	1件	
钟表螺丝刀十字PH0X60mm	1件	
双色柄钢丝钳6"	1件	
双色柄尖嘴钳6"	1件	
三色套柄活扳手8"	1件	
6.3mm系列旋柄	1件	
批头	20件	
双色包塑美工刀18mm	1件	
双色包塑自锁卷尺5M	1件	
双色钢管柄羊角锤12OZ	1件	
小五金100PC	1件	
公制内六角	11件	
铝合金手电筒9LED	1件	
数显测电笔	1件	
绝缘胶带9M	1件	
手锯10"	1件	
不锈钢直尺300mm	1件	

62件套高级通用工具组套 / 货号：W1157



组件	件数	适用范围
三色柄螺丝刀一字6X100mm	1件	门窗家具 水管龙头 家用电器 手机数码 设备检修 物业维修 车辆维修
三色柄螺丝刀十字PH2X100mm	1件	
钟表螺丝刀一字1.4X60mm	1件	
钟表螺丝刀一字1.8X60mm	1件	
钟表螺丝刀一字2.5X60mm	1件	
钟表螺丝刀一字3.0X60mm	1件	
钟表螺丝刀十字PH00X60mm	1件	
钟表螺丝刀十字PH0X60mm	1件	
双色柄钢丝钳6"	1件	
双色柄尖嘴钳6"	1件	
三色柄活扳手8"	1件	
6.3mm系列旋柄	1件	
6.3mm系列起子变换头	1件	
批头	20件	
双色包塑美工刀18mm	1件	
双色包塑自锁卷尺5M	1件	
双色钢管柄羊角锤12OZ	1件	
公制内六角	11件	
公制强力套筒	9件	
铝合金手电筒9LED	1件	
数显测电笔	1件	
鹰嘴剥线钳 (10-20AWG)	1件	
绝缘胶带9M	1件	
手锯10"	1件	
电烙铁30W (CCC认证)	1件	

63件套电讯工具组套 / 货号：W2163

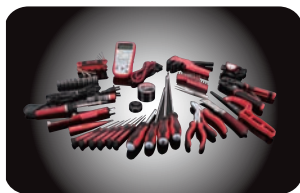

组件	件数	适用范围
三色柄特长螺丝刀一字6x250mm	1件	适用于： 拆装、检 测和维修 家用电器、 网络设备、 通讯器材和 手机数码等
三色柄特长螺丝刀十字PH2X250mm	1件	
三色柄特长螺丝刀十字PH1X200mm	1件	
双色柄钟表螺丝刀一字1.4x60mm	1件	
双色柄钟表螺丝刀一字1.8x60mm	1件	
双色柄钟表螺丝刀一字2.5x60mm	1件	
双色柄钟表螺丝刀一字3.0x60mm	1件	
双色柄钟表螺丝刀十字PH00x60mm	1件	
双色柄钟表螺丝刀十字PH0x60mm	1件	
6.3mm系列旋柄	1件	
6.3mm起子变换头	1件	
批头	20件	
双色柄尖嘴钳6寸	1件	
双色柄斜嘴钳6寸	1件	
鹰嘴剥线钳	1件	
网络压接钳6P8P	1件	
公制强力套筒	9件	
自动量程数字万用表	1件	
电烙铁30W (CCC认证)	1件	
焊锡丝10g	1件	
全铝吸锡器	1件	
尖头镊子	1件	
弯刃电工刀	1件	
公制折叠内六角	9件	
手锯10寸	1件	
数显测电笔	1件	
绝缘胶带9M	1件	
工作头灯	1件	



高性能万用表：

本万用表是一款功能齐全，性能稳定，结构新颖，功耗低，安全可靠的手持式自动量程数字万用表。



超长电讯专用螺丝刀：

使用高档CR-V材质。整体热处理，表面镀珍珠镍。刀头高频淬火处理，硬度高。刀杆长达250mm。



高性能6P/8P网络压接钳：

高档锌合金材质压接头，压接更加精密和牢固。带可调节棘轮省力杆，可快速回弹，更加省力。



LED头灯：

使用2LED节能头灯，LED寿命长达10万小时，可在光线不足的作业条件下补充光线，提高作业效率。



长寿命电烙铁：

采用铜合金双层覆盖长寿命烙铁头，可更换发热芯，产品通过3C认证。



高品质工具箱：

上下盖采用坚固的金属插销弹簧结构连接，寿命提高一倍以上。采用高档锌合金压铸锁扣，结实耐用。

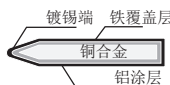

19件套家用工具组套 / 货号：W1219



组件	件数	适用范围
双色柄钢丝钳6"	1件	门窗家具 水管龙头 安装拆卸 随车应急 设备检修 自行车维修
活扳手8"	1件	
三色柄螺丝刀通用手柄	1件	
螺丝刀刀头	10件	
双色防滑柄羊角锤8oz	1件	
双色包胶自锁卷尺3M	1件	
铝合金手电筒6LED	1件	
不锈钢多功能水果刀	1件	
测电笔	1件	
绝缘胶带9m	1件	

14件套高级家用工具组套 / 货号：W1214



组件	件数	适用范围
双色柄尖嘴钳6"	1件	厨具 家具 电脑 电器 自行车维修等
铬钒钢螺丝刀一字6x100mm	1件	
铬钒钢螺丝刀十字PH2x100mm	1件	
钢卷尺3m	1件	
公制内六角	8件	
美工刀18mm	1件	
测电笔	1件	

10件套高级家用工具组套 / 货号：W1210



组件	件数	适用范围
双色柄尖嘴钳6"	1件	门窗家具 水管龙头 安装拆卸 随车应急 设备检修 自行车维修
活扳手8"	1件	
铬钒钢螺丝刀一字6x100mm	1件	
铬钒钢螺丝刀十字PH2x100mm	1件	
钟表螺丝刀一字2.5x60mm	1件	
钟表螺丝刀十字PH0x60mm	1件	
钢管柄羊角锤8oz	1件	
钢卷尺3m	1件	
铝合金手电筒6LED	1件	
美工刀18mm	1件	

居家维修工具5件套 / 货号：W1705



品名	件数	适用范围
7合1多用换头螺丝刀	1件	门窗家具 家用电器 水管龙头 设备检修 安装制作 随车应急
双色短柄大开口活扳手	1件	
双色短柄防滑羊角锤	1件	
双色镀镍钢丝钳6寸	1件	
双色包胶自锁卷尺3m	1件	

货号 Item no.	页码 Page No.	货号 Item no.	页码 Page No.	货号 Item no.	页码 Page No.	货号 Item no.	页码 Page No.	货号 Item no.	页码 Page No.	货号 Item no.	页码 Page No.	货号 Item no.	页码 Page No.	货号 Item no.	页码 Page No.
S010001	2	S010711	11	S012015	12	S013007	14	S014425	18	S016104	26	S016235	132	S016379	30
S010002	2	S010712	11	S012016	12	S013010	14	S014427	18	S016105	26	S016236	132	S016380	30
S010003	5	S010713	11	S012017	12	S013011	14	S014430	18	S016106	26	S016237	132	S016381	30
S010004	6	S010714	11	S012018	12	S013100	14	S014440	18	S016107	26	S016238	132	S016382	30
S010015	6	S010715	11	S012019	12	S013101	14	S014445	18	S016108	27	S016239	132	S016388	30
S010020	5	S010716	11	S012020	12	S013102	14	S014450	18	S016109	27	S016301	27	S016389	30
S010024	5	S010717	11	S012021	12	S013103	14	S014455	18	S016110	27	S016302	27	S016390	30
S010025	5	S010718	11	S012022	12	S013105	14	S014460	18	S016120	27	S016303	27	S016391	30
S010026	4	S010719	11	S012023	12	S013107	15	S014603	18	S016121	27	S016304	27	S016392	30
S010028	4	S010720	11	S012024	12	S013109	15	S014604	18	S016122	27	S016305	27	S016393	30
S010031	5	S010721	11	S012025	12	S013110	15	S014605	18	S016123	27	S016306	28	S016401	29
S010032	5	S010722	11	S012026	12	S013111	15	S014606	18	S016124	27	S016307	28	S016402	29
S010035	6	S011414	11	S012027	12	S013112	15	S014607	18	S016125	27	S016308	28	S016403	29
S010038	6	S011415	121	S012030	12	S013200	15	S014608	18	S016126	27	S016309	28	S016404	29
S010042	3	S011416	11	S012032	12	S013201	15	S014610	18	S016127	27	S016310	28	S016405	29
S010057	40	S011421	11	S012110	12	S013202	15	S015220	18	S016128	27	S016311	28	S016406	29
S010058	4	S011508	11	S012112	12	S013203	15	S015225	18	S016131	28	S016312	28	S016407	29
S010061	4	S011510	11	S012113	12	S013204	15	S015227	18	S016132	28	S016313	28	S016408	29
S010064	3	S011511	11	S012114	12	S013205	15	S015230	18	S016133	28	S016314	28	S016409	29
S010079	3	S011512	11	S012117	12	S013206	15	S015240	18	S016134	28	S016315	28	S016410	29
S010086	3	S011514	11	S012119	12	S013207	15	S015245	18	S016135	28	S016316	29	S016411	29
S010104	11	S011516	11	S012201	12	S013208	16	S015250	18	S016136	28	S016317	29	S016412	29
S010105	11	S011518	11	S012202	12	S013210	16	S015255	18	S016137	28	S016318	28	S016413	29
S010106	11	S011520	11	S012203	12	S013211	16	S015260	18	S016138	28	S016319	28	S016414	29
S010107	11	S011608	12	S012204	12	S013220	16	S015270	18	S016141	29	S016320	28	S016415	29
S010108	11	S011609	12	S012205	12	S013301	16	S015271	18	S016142	29	S016330	30	S016416	29
S010109	11	S011610	12	S012206	12	S013302	16	S015272	18	S016143	29	S016331	30	S016417	29
S010110	11	S011611	12	S012207	12	S013303	16	S015273	18	S016144	29	S016332	30	S016418	29
S010111	11	S011612	12	S012208	12	S013304	16	S015274	18	S016145	29	S016333	30	S016431	29
S010112	11	S011613	12	S012209	12	S013309	16	S015275	18	S016146	29	S016334	30	S016432	29
S010113	11	S011614	12	S012210	12	S013310	16	S015276	18	S016147	29	S016335	30	S016433	29
S010114	11	S011615	12	S012211	12	S013311	16	S015278	19	S016148	29	S016336	30	S016434	29
S010145	11	S011616	12	S012212	12	S013501	17	S015279	19	S016149	29	S016337	30	S016435	29
S010155	11	S011617	12	S012213	12	S013502	17	S015280	19	S016150	29	S016338	30	S016436	29
S010204	11	S011618	12	S012214	12	S013604	17	S015281	19	S016151	29	S016339	30	S016437	29
S010205	11	S011619	12	S012215	12	S013655	17	S015282	19	S016152	29	S016340	30	S016438	29
S010206	11	S011620	12	S012216	12	S013665	17	S015283	19	S016153	29	S016342	30	S016439	29
S010207	11	S011621	12	S012217	12	S013808	17	S015305	18	S016154	29	S016343	30	S016440	29
S010208	11	S011622	12	S012218	12	S013810	17	S015306	18	S016155	29	S016345	30	S016441	29
S010209	11	S011623	12	S012219	12	S013815	17	S015308	18	S016156	29	S016350	30	S016442	29
S010210	11	S011624	12	S012416	12	S013820	17	S015310	18	S016157	29	S016352	30	S016443	29
S010211	11	S011627	12	S012421	12	S013825	17	S015312	18	S016158	29	S016353	30	S016444	29
S010212	11	S011630	12	S012819	13	S013827	17	S015314	18	S016159	29	S016354	30	S016501	30
S010213	11	S011632	12	S012821	13	S013830	17	S015317	18	S016160	29	S016356	30	S016502	30
S010606	11	S011634	12	S012822	13	S013840	17	S015505	18	S016161	29	S016358	30	S016503	30
S010607	11	S011710	12	S012824	13	S013903	17	S015506	18	S016162	29	S016359	30	S016504	30
S010608	11	S011712	12	S012826	13	S013904	17	S015507	18	S016163	29	S016360	30	S016505	30
S010609	11	S011713	12	S012827	13	S013905	17	S015508	18	S016164	29	S016361	30	S016507	30
S010610	11	S011714	12	S012829	13	S013906	17	S015510	18	S016165	29	S016362	30	S016508	30
S010611	11	S011715	12	S012830	13	S013907	17	S015512	18	S016201	29	S016363	30	S016509	30
S010612	11	S011716	12	S012832	13	S013908	17	S015514	18	S016202	29	S016364	30	S016510	30
S010613	11	S011717	12	S012834	13	S013910	17	S015806	19	S016203	29	S016365	30	S016511	30
S010614	11	S011718	12	S012836	13	S014101	17	S015808	19	S016221	30	S016366	30	S016512	30
S010615	11	S011719	12	S012838	13	S014102	17	S015810	19	S016222	30	S016367	30	S016513	30
S010616	11	S011720	12	S012841	13	S014103	17	S015812	19	S016223	30	S016368	30	S016514	30
S010617	11	S011721	12	S012846	13	S014204	18	S016008	19	S016224	30	S016369	30	S016515	30
S010618	11	S011722	12	S012850	13	S014208	18	S016010	19	S016225	30	S016370	30	S016516	30
S010619	11	S011724	12	S012855	13	S014255	18	S016012	19	S016226	30	S016371	30	S016517	30
S010620	11	S011727	12	S012860	13	S014265	18	S016013	19	S016227	30	S016372	30	S016518	30
S010621	11	S012008	12	S013000	13	S014301	17	S016014	19	S016228	30	S016373	30	S016519	30
S010622	11	S012010	12	S013001	13	S014302	17	S016017	19	S016229	30	S016374	30	S016520	30
S010624	11	S012011	12	S013002	13	S014303	17	S016019	19	S016231	132	S016375	30	S016521	30
S010708	11	S012012	12	S013003	13	S014410	18	S016101	26	S016232	132	S016376	30	S016522	30
S010709	11	S012013	12	S013005	14	S014415	18	S016102	26	S016233	132	S016377	30	S016524	30
S010710	11	S012014	12	S013006	14	S014420	18	S016103	26	S016234	132	S016378	30	S016526	30

货号 Item no.	页码 Page No.	货号 Item no.	页码 Page No.	货号 Item no.	页码 Page No.	货号 Item no.	页码 Page No.	货号 Item no.	页码 Page No.	货号 Item no.	页码 Page No.	货号 Item no.	页码 Page No.	货号 Item no.	页码 Page No.
S016527	30	S016610	19	S017311	22	S017630	22	S018901	24	S019535	26	S025024	7	S035018	47
S016528	30	S016611	30	S017312	22	S017632	22	S018902	24	S019536	26	S025025	7	S035019	47
S016535	30	S016612	19	S017313	22	S017634	22	S018908	25	S019537	26	S025026	7	S035022	48
S016536	30	S016613	30	S017314	22	S017636	22	S018909	25	S019538	26	S025027	7	S035023	48
S016537	30	S016614	30	S017315	22	S018101	21	S018910	25	S019539	26	S025028	7	S035024	48
S016538	30	S016615	19	S017316	22	S018102	21	S018911	25	S019540	26	S025029	7	S035025	48
S016539	30	S016618	19	S017317	22	S018106	23	S018912	25	S019541	26	S025030	8	S035026	48
S016540	30	S016624	19	S017318	22	S018107	23	S018913	25	S019554	26	S025031	8	S035027	48
S016541	30	S016706	19	S017319	22	S018108	23	S018914	25	S019555	26	S025032	8	S035028	48
S016542	30	S016708	19	S017320	22	S018110	23	S018915	25	S019556	26	S025041	8	S035029	48
S016543	30	S016710	19	S017321	22	S018111	23	S018916	25	S019557	26	S025042	8	S035031	48
S016544	30	S016712	19	S017322	22	S018112	23	S018917	25	S019558	26	S025043	8	S035032	48
S016545	30	S016906	19	S017323	22	S018113	23	S018918	25	S019559	26	S026001	35	S035033	48
S016546	30	S016908	19	S017324	22	S018114	23	S018919	25	S019560	26	S026002	35	S035034	49
S016547	30	S016910	19	S017325	22	S018115	23	S019008	25	S019561	26	S030001	41	S035035	49
S016550	30	S016912	19	S017327	22	S018116	23	S019012	25	S019562	26	S030003	41	S035036	49
S016551	30	S017100	20	S017330	22	S018117	23	S019014	25	S019563	26	S030004	41	S035037	49
S016552	30	S017101	20	S017332	22	S018119	23	S019016	25	S019564	26	S030005	41	S035039	44
S016553	30	S017102	20	S017401	20	S018120	23	S019017	25	S020001	4	S030006	40	S035041	46
S016554	30	S017103	20	S017402	21	S018121	23	S019108	24	S022001	32	S030007	40	S035042	46
S016555	30	S017104	19	S017406	22	S018122	23	S019109	24	S022002	32	S030008	40	S035043	46
S016556	30	S017105	20	S017407	22	S018123	23	S019110	24	S022003	32	S030009	42	S035044	46
S016557	30	S017106	21	S017408	22	S018124	23	S019113	24	S022005	4	S030010	41	S035045	46
S016560	30	S017107	21	S017409	22	S018127	23	S019310	25	S023001	33	S030011	41	S035046	46
S016563	30	S017108	21	S017410	22	S018130	23	S019312	25	S023002	33	S030012	41	S035050	47
S016564	30	S017109	21	S017411	22	S018132	23	S019314	25	S023003	33	S030013	42	S035051	45
S016565	30	S017110	21	S017412	22	S018134	23	S019317	25	S023004	33	S030014	42	S035052	45
S016566	30	S017111	21	S017413	22	S018135	23	S019319	25	S023005	33	S030016	41	S035053	45
S016567	30	S017112	21	S017414	22	S018136	23	S019322	25	S023006	33	S030017	41	S035054	45
S016568	30	S017113	21	S017415	22	S018141	23	S019324	25	S023007	33	S030021	42	S035055	46
S016569	30	S017114	21	S017416	22	S018601	24	S019326	25	S023008	33	S030022	41	S035056	46
S016570	30	S017115	21	S017417	22	S018602	24	S019330	25	S023009	33	S030023	41	S035057	46
S016571	30	S017116	21	S017418	22	S018608	25	S019332	25	S023010	33	S031001	45	S036001	49
S016572	30	S017117	21	S017419	22	S018609	25	S019336	25	S023011	33	S031002	45	S036002	49
S016573	30	S017118	21	S017420	22	S018610	25	S019501	25	S023012	32	S031003	45	S036003	49
S016574	30	S017119	21	S017421	22	S018611	25	S019502	25	S023013	32	S031004	45	S036004	49
S016575	30	S017120	21	S017507	23	S018612	25	S019503	25	S023014	34	S033001	40	S036010	49
S016576	30	S017121	21	S017508	23	S018613	25	S019504	25	S023015	34	S033002	40	S037001	49
S016577	30	S017122	21	S017510	23	S018614	25	S019505	25	S023019	32	S033003	40	S037002	50
S016578	30	S017123	21	S017512	23	S018615	25	S019506	25	S024004	34	S033004	41	S037003	50
S016581	30	S017124	21	S017513	23	S018616	25	S019507	25	S024005	34	S034001	43	S037004	51
S016582	30	S017125	21	S017514	23	S018617	25	S019508	25	S024006	34	S034002	43	S037005	51
S016583	30	S017127	21	S017516	23	S018618	25	S019509	25	S024011	34	S034003	44	S037007	50
S016584	30	S017130	21	S017517	23	S018619	25	S019510	25	S024012	34	S034004	44	S037008	50
S016585	30	S017132	21	S017518	23	S018621	25	S019511	25	S024013	34	S034005	42	S037015	50
S016586	30	S017134	21	S017519	23	S018622	25	S019512	25	S024014	34	S034010	44	S037101	50
S016588	30	S017135	21	S017601	21	S018624	25	S019513	25	S024015	34	S034011	44	S037102	50
S016589	30	S017136	21	S017602	21	S018627	25	S019514	25	S025001	34	S034012	44	S037103	50
S016590	30	S017138	21	S017603	21	S018630	25	S019515	25	S025002	34	S034013	44	S037104	50
S016591	30	S017141	21	S017606	22	S018632	25	S019516	25	S025003	35	S035001	45	S037105	50
S016593	30	S017146	21	S017608	22	S018808	25	S019517	25	S025004	35	S035002	45	S037106	50
S016595	30	S017150	21	S017610	22	S018810	25	S019521	26	S025005	35	S035003	45	S037107	50
S016597	30	S017155	21	S017611	22	S018812	25	S019522	26	S025006	38	S035004	45	S037108	50
S016598	30	S017156	21	S017612	22	S018813	25	S019523	26	S025007	38	S035005	45	S037111	50
S016599	30	S017160	21	S017613	22	S018814	25	S019524	26	S025008	38	S035006	45	S037112	50
S016600	30	S017165	21	S017614	22	S018816	25	S019525	26	S025009	38	S035007	46	S037113	50
S016601	30	S017213	22	S017616	22	S018817	25	S019526	26	S025010	35	S035008	46	S037114	50
S016602	30	S017301	20	S017617	22	S018818	25	S019527	26	S025011	38	S035009	47	S037116	50
S016603	30	S017303	20	S017619	22	S018819	25	S019528	26	S025012	38	S035010	47	S037121	50
S016604	19	S017304	20	S017620	22	S018821	25	S019529	26	S025013	35	S035011	47	S037122	50
S016605	30	S017306	22	S017621	22	S018822	25	S019530	26	S025014	35	S035013	47	S037123	50
S016606	19	S017307	22	S017622	22	S018824	25	S019531	26	S025015	36	S035014	47	S037124	50
S016607	30	S017308	22	S017623	22	S018827	25	S019532	26	S025021	6	S035015	47	S037125	50
S016608	19	S017309	22	S017624	22	S018830	25	S019533	26	S025022	6	S035016	47	S037126	50
S016609	30	S017310	22	S017627	22	S018832	25	S019534	26	S025023	7	S035017	47	S037127	50

货号 Item no.	页码 Page No.	货号 Item no.	页码 Page No.	货号 Item no.	页码 Page No.	货号 Item no.	页码 Page No.	货号 Item no.	页码 Page No.	货号 Item no.	页码 Page No.	货号 Item no.	页码 Page No.	货号 Item no.	页码 Page No.
S037128	50	S045012	69	S050004	75	S050410	78	S051004	79	S053134	88	S055208	81	S056302	83
S037253	102	S045015	69	S050005	75	S050412	78	S051005	79	S053135	88	S055209	81	S056303	83
S038010	51	S045016	70	S050006	75	S050414	78	S051006	79	S053136	88	S055210	81	S056304	83
S038011	51	S046001	56	S050007	75	S050415	78	S051007	79	S053137	88	S055211	81	S056305	83
S038012	51	S046010	56	S050008	75	S050416	78	S051008	79	S053138	88	S055212	81	S056306	83
S038013	51	S046011	56	S050009	75	S050417	78	S051009	79	S053155	88	S055213	81	S056307	83
S038037	51	S046012	56	S050010	76	S050418	78	S051010	79	S053201	88	S055214	81	S056308	83
S038038	51	S046013	56	S050011	76	S050419	78	S051012	79	S053202	88	S055215	81	S056309	83
S038039	51	S046014	56	S050012	76	S050422	78	S051014	79	S053203	88	S055216	81	S056310	83
S038041	51	S046015	57	S050013	76	S050424	78	S051016	79	S053204	88	S056001	81	S056401	83
S038042	51	S046016	57	S050014	76	S050425	78	S051020	79	S053205	88	S056002	81	S056402	83
S038043	51	S046017	57	S050015	76	S050427	78	S051024	79	S053206	88	S056003	82	S056403	83
S038044	51	S047001	71	S050016	76	S050455	78	S052001	80	S053207	88	S056005	82	S056404	83
S038045	51	S047003	71	S050017	76	S050502	78	S052002	80	S053208	88	S056006	82	S056405	83
S038046	52	S047007	71	S050018	76	S050503	78	S052003	80	S053209	88	S056007	82	S056406	83
S038047	51	S047011	71	S050019	76	S050504	78	S052004	80	S053210	88	S056008	82	S056407	83
S038048	52	S047015	71	S050020	77	S050505	78	S052011	81	S053211	88	S056009	82	S056408	83
S040000	67	S047021	72	S050021	77	S050506	78	S052012	81	S053212	88	S056011	83	S056409	83
S040002	67	S047022	72	S050022	77	S050507	78	S053001	87	S053214	88	S056101	83	S056410	83
S040003	67	S047023	72	S050023	77	S050508	78	S053002	87	S053215	88	S056102	83	S056411	83
S040004	67	S047024	72	S050024	77	S050510	78	S053003	87	S053216	88	S056103	83	S056412	83
S040005	67	S047025	72	S050025	77	S050515	78	S053004	87	S053217	88	S056104	83	S056413	83
S040006	67	S047026	72	S050026	77	S050525	78	S053005	87	S053220	88	S056105	83	S056414	83
S040008	67	S047027	72	S050027	78	S050602	78	S053006	87	S053221	88	S056106	83	S056415	83
S041001	67	S047028	72	S050102	79	S050603	78	S053007	87	S053223	88	S056107	83	S056416	83
S041002	67	S047029	72	S050103	79	S050604	78	S053011	87	S053224	88	S056108	83	S056417	83
S041003	67	S047030	72	S050104	79	S050605	78	S053012	87	S053225	88	S056109	83	S056418	83
S042001	71	S047031	72	S050105	79	S050606	78	S053013	87	S053226	88	S056110	83	S056419	83
S042002	71	S047032	72	S050106	79	S050607	78	S053014	87	S053227	88	S056111	83	S056420	83
S042003	71	S047033	72	S050107	79	S050608	78	S053015	87	S053240	88	S056112	83	S056501	84
S042004	71	S047034	72	S050108	79	S050610	78	S053016	87	S053241	88	S056113	83	S056502	85
S042005	70	S047035	72	S050110	79	S050615	78	S053017	87	S053242	88	S056114	83	S056503	85
S042006	70	S047036	72	S050115	79	S050625	78	S053018	87	S053243	88	S056115	83	S056504	85
S042007	70	S048001	72	S050125	79	S050706	79	S053019	87	S053244	87	S056116	83	S056505	85
S043001	70	S048002	72	S050202	78	S050707	79	S053020	87	S053245	87	S056117	83	S056506	85
S043002	70	S048003	72	S050203	78	S050708	79	S053021	87	S053246	87	S056118	83	S056507	85
S043003	70	S048004	72	S050204	78	S050709	79	S053022	87	S053247	87	S056119	83	S056508	84
S043004	70	S048005	72	S050205	78	S050710	79	S053023	87	S053248	87	S056120	83	S056510	84
S043005	70	S048006	73	S050206	78	S050715	79	S053024	87	S053401	87	S056121	83	S056703	83
S043006	70	S048007	73	S050207	78	S050720	79	S053025	87	S053402	87	S056122	83	S056705	83
S043007	70	S048008	73	S050208	78	S050725	79	S053026	87	S053403	87	S056166	88	S056706	83
S043008	70	S048009	73	S050210	78	S050727	79	S053027	87	S054002	86	S056169	87	S056707	83
S044001	68	S048010	73	S050215	78	S050730	79	S053028	87	S055101	81	S056201	83	S056708	83
S044002	68	S048011	73	S050225	78	S050740	79	S053029	87	S055102	81	S056202	83	S057002	55
S044003	68	S049001	67	S050302	79	S050745	79	S053030	87	S055103	81	S056203	83	S057301	55
S044005	68	S049002	67	S050303	79	S050750	79	S053031	87	S055104	81	S056204	83	S057302	55
S044006	68	S049003	67	S050304	79	S050755	79	S053032	87	S055105	81	S056205	83	S057303	55
S044008	68	S049004	67	S050305	79	S050802	80	S053033	87	S055106	81	S056206	83	S057304	55
S044009	68	S049006	67	S050306	79	S050803	80	S053034	87	S055107	81	S056207	83	S057401	55
S044010	68	S049008	67	S050307	79	S050804	80	S053035	87	S055108	81	S056208	83	S057402	55
S044011	68	S049101	67	S050308	79	S050805	80	S053036	87	S055109	81	S056209	83	S057403	55
S044012	68	S049102	67	S050310	79	S050806	80	S053037	87	S055110	81	S056210	83	S057404	55
S044013	68	S049104	67	S050312	79	S050807	80	S053103	87	S055111	81	S056211	83	S058101	85
S044014	68	S049105	67	S050314	79	S050808	80	S053104	87	S055112	81	S056212	83	S058102	85
S044015	68	S049106	67	S050315	79	S050810	80	S053105	87	S055113	81	S056213	83	S058103	85
S045001	68	S049107	67	S050317	79	S050825	80	S053106	87	S055114	81	S056214	83	S058104	85
S045002	68	S049201	67	S050325	79	S050902	80	S053110	88	S055115	81	S056215	83	S058105	85
S045003	68	S049202	67	S050355	79	S050903	80	S053111	88	S055116	81	S056216	83	S058201	85
S045004	69	S049203	67	S050402	78	S050904	80	S053112	88	S055201	81	S056217	83	S058202	85
S045005	69	S049204	67	S050403	78	S050905	80	S053115	88	S055202	81	S056218	83	S058203	85
S045006	69	S049205	67	S050404	78	S050906	80	S053116	88	S055203	81	S056219	83	S058204	85
S045007	69	S049206	67	S050405	78	S050907	80	S053117	88	S055204	81	S056220	83	S058205	85
S045008	69	S050001	75	S050406	78	S050908	80	S053118	88	S055205	81	S056221	83	S058305	86
S045009	69	S050002	75	S050407	78	S050910	80	S053132	88	S055206	81	S056222	83	S058306	86
S045011	69	S050003	75	S050408	78	S050925	80	S053133	88	S055207	81	S056301	83	S058308	86

货号 Item no.	页码 Page No.	货号 Item no.	页码 Page No.	货号 Item no.	页码 Page No.	货号 Item no.	页码 Page No.	货号 Item no.	页码 Page No.	货号 Item no.	页码 Page No.	货号 Item no.	页码 Page No.	货号 Item no.	页码 Page No.
S058401	86	S068104	93	S078248	97	S088432	102	S099112	106	S104012	114	S113016	119	S117018	125
S059001	86	S068207	93	S078318	97	S088440	102	S099201	106	S104014	114	S113017	119	S117019	125
S059002	86	S068210	93	S078324	97	S088620	103	S099202	106	S104018	114	S113018	119	S117020	124
S059003	86	S068212	93	S078340	97	S088630	103	S099203	106	S104024	114	S113019	119	S117021	125
S059004	86	S068308	93	S078348	97	S088650	103	S099204	106	S104036	114	S113020	119	S117022	122
S059005	86	S068310	93	S079001	97	S088680	103	S099205	107	S104048	114	S113021	119	S117023	122
S059006	86	S068312	93	S079002	97	S088713	103	S099206	107	S104110	114	S113022	119	S123001	133
S059007	86	S068314	93	S079003	97	S088715	103	S099207	107	S104112	114	S113023	119	S123002	133
S059008	86	S069001	93	S079006	97	S088718	103	S099208	107	S104114	114	S113024	119	S123003	133
S059009	86	S069002	94	S079007	97	S088720	103	S099209	107	S104118	114	S113025	120	S123004	133
S059010	86	S069003	94	S079008	97	S088722	103	S099210	107	S104124	114	S113026	120	S123005	133
S059011	86	S069004	94	S079012	97	S088728	103	S099211	107	S104136	114	S113027	120	S123007	133
S059012	86	S069005	94	S079020	97	S088735	103	S099212	107	S104148	114	S113028	120	S123008	133
S059013	86	S069006	94	S079040	97	S088742	103	S099305	107	S104218	114	S113029	120	S123009	133
S059014	86	S069106	94	S080001	100	S088750	103	S099306	107	S104224	114	S113030	120	S123010	133
S059015	86	S069118	94	S080002	100	S088816	103	S099307	107	S104236	114	S113031	120	S123011	133
S059016	86	S069124	94	S080003	100	S088824	103	S099308	107	S104248	114	S113032	120	S123012	133
S059017	86	S069132	94	S080004	100	S088935	103	S099401	107	S110001	116	S113033	120	S123013	133
S059018	86	S069134	94	S080101	100	S088945	103	S099402	107	S110002	116	S113034	120	S123014	133
S059019	86	S069135	94	S080102	100	S088955	103	S099403	107	S111001	117	S113035	120	S123015	133
S059020	86	S069201	94	S080103	100	S088965	103	S099404	107	S111002	117	S113036	120	S123016	133
S059100	81	S069216	94	S080104	100	S089020	103	S099405	107	S111003	117	S113038	121	S123017	133
S066008	90	S069218	94	S080105	100	S089102	103	S099406	107	S111004	117	S113039	121	S123018	133
S066012	90	S069220	94	S080106	100	S089103	103	S099407	107	S111010	117	S113040	121	S123019	133
S066014	90	S070013	96	S080108	100	S089104	103	S099408	107	S111011	117	S113041	121	S123108	133
S066018	90	S070014	96	S080109	100	S089106	103	S099409	107	S111012	117	S113042	121	S123109	133
S066024	90	S070023	96	S080110	100	S089108	103	S099410	107	S111013	117	S113043	121	S123110	133
S066030	90	S070032	96	S080111	101	S089110	103	S099411	107	S111014	117	S113044	118	S123111	133
S066036	90	S071001	98	S080201	101	S089112	103	S099412	107	S111015	118	S113045	118	S123112	133
S067002	90	S071002	98	S080202	101	S089114	103	S099501	107	S112001	118	S113051	121	S123113	133
S067004	90	S071003	98	S080203	101	S089301	103	S099502	107	S112002	118	S113052	121	S123114	133
S067005	90	S071011	98	S080210	101	S089302	103	S099503	107	S112003	118	S113055	121	S123115	133
S067007	90	S071012	98	S080212	101	S089303	103	S099504	107	S112004	118	S113056	116	S123116	133
S067008	90	S072001	98	S080216	101	S090001	105	S099505	107	S112005	118	S113058	125	S123117	133
S067011	90	S072002	98	S080219	101	S090002	105	S099506	107	S112006	118	S113059	125	S123118	133
S067013	90	S077002	96	S080222	101	S090003	105	S099507	107	S112007	118	S114011	122	S123119	133
S067014	90	S077003	96	S080225	101	S090004	105	S099508	107	S112008	121	S114013	122	S123202	134
S067015	90	S077005	96	S080301	101	S090005	105	S099509	107	S112009	114	S114015	121	S123204	134
S067109	91	S077075	96	S080312	102	S090006	105	S099510	107	S112010	114	S115001	122	S123206	134
S067118	91	S077105	96	S080319	102	S090007	105	S099511	107	S112011	118	S116001	122	S123207	134
S067201	91	S077135	96	S080325	102	S090008	105	S099512	107	S112012	118	S116002	122	S123208	134
S067202	91	S077155	96	S081014	102	S090009	105	S100022	113	S112013	119	S116003	122	S123210	133
S067210	91	S077175	96	S081024	102	S090101	105	S100032	113	S112014	118	S116004	122	S123211	133
S067211	91	S077205	96	S081036	102	S090102	105	S100045	113	S112021	118	S116005	123	S123212	133
S067212	91	S077235	96	S081059	102	S090103	105	S100063	113	S112022	119	S116006	123	S123213	133
S067213	91	S077255	96	S081114	102	S090104	105	S100101	113	S112023	119	S116007	123	S123214	133
S067214	91	S077275	96	S081124	102	S090105	105	S100102	113	S112024	119	S116008	123	S123215	133
S067215	92	S077320	96	S081136	102	S090106	105	S101001	113	S112025	119	S116009	123	S123216	133
S067216	92	S077330	96	S088002	102	S090107	106	S101101	113	S112026	119	S117001	123	S123217	133
S067217	92	S077350	96	S088008	102	S090108	106	S102000	113	S112027	119	S117002	123	S123218	133
S067218	92	S077430	96	S088016	102	S090109	106	S102002	113	S112028	119	S117003	123	S123219	133
S067219	92	S077450	96	S088116	102	S092002	106	S102006	114	S112029	119	S117004	123	S123221	133
S067220	92	S077503	97	S088120	102	S092003	106	S102008	114	S112030	119	S117005	123	S123222	133
S067221	92	S077505	97	S088124	102	S092010	106	S102010	114	S112031	119	S117006	124	S123223	133
S067301	92	S077520	96	S088208	102	S099101	106	S102012	114	S112032	119	S117007	124	S123224	133
S067302	92	S077530	96	S088212	102	S099102	106	S102022	114	S112033	119	S117008	124	S123227	133
S067303	93	S077575	97	S088216	102	S099103	106	S102025	114	S112034	119	S117009	124	S123230	133
S067304	92	S078009	97	S088220	102	S099104	106	S102106	114	S112035	119	S117010	124	S123232	133
S067306	93	S078118	97	S088316	102	S099105	106	S102108	114	S113000	119	S117011	124	S123310	133
S067307	93	S078124	97	S088324	102	S099106	106	S102110	114	S113010	119	S117012	124	S123311	133
S068001	93	S078140	97	S088332	102	S099107	106	S102112	114	S113011	119	S117013	124	S123312	133
S068002	93	S078148	97	S088408	102	S099108	106	S103001	114	S113012	119	S117014	125	S123313	133
S068101	93	S078218	97	S088412	102	S099109	106	S104006	114	S113013	119	S117015	125	S123314	133
S068102	93	S078224	97	S088416	102	S099110	106	S104008	114	S113014	119	S117016	125	S123315	133
S068103	93	S078240	97	S088424	102	S099111	106	S104010	114	S113015	119	S117017	125	S123316	133

货号 Item no.	页码 Page No.	货号 Item no.	页码 Page No.	货号 Item no.	页码 Page No.	货号 Item no.	页码 Page No.	货号 Item no.	页码 Page No.	货号 Item no.	页码 Page No.	货号 Item no.	页码 Page No.	货号 Item no.	页码 Page No.
S123317	133	S134003	109	S137013	110	S150046	62	S151042	56	S154035	60	S160016	127	W1219	142
S123318	133	S134004	109	S137014	110	S150047	63	S151043	56	S154036	60	S160017	127	W1705	142
S123319	133	S134005	109	S137015	110	S150048	63	S151044	56	S154045	59	S160018	127	W2163	141
S123321	133	S134006	109	S137016	110	S150049	63	S151045	56	S155001	61	S160021	127		
S123322	133	S134007	109	S137017	110	S150050	62	S151051	55	S155002	61	S160022	127		
S123324	133	S134011	110	S137018	110	S150051	58	S151052	55	S155003	61	S160023	127		
S123327	133	S134012	110	S137019	110	S150052	58	S151053	55	S155004	61	S160024	127		
S123330	133	S134013	110	S137020	110	S150060	59	S151061	56	S155005	61	S160051	130		
S123332	133	S135001	109	S137021	110	S150062	59	S151062	56	S155006	61	S160052	130		
S123402	134	S135002	109	S137022	110	S150063	59	S151063	56	S155007	61	S160053	130		
S123405	134	S135003	109	S137023	110	S150064	59	S151064	56	S155008	61	S160054	130		
S123406	134	S135004	109	S137024	110	S150065	59	S151065	56	S155009	61	S170001	52		
S123407	134	S135005	109	S137025	110	S150066	59	S152006	58	S155010	61	S170002	52		
S123408	134	S135006	109	S137026	110	S150068	59	S152007	58	S155011	61	S170003	52		
S123417	134	S135007	109	S137027	110	S150070	58	S152008	58	S155012	61	S170004	52		
S123418	134	S135101	109	S137028	110	S150075	61	S152009	58	S155015	59	S170011	52		
S123419	134	S136001	110	S137029	110	S150080	63	S152010	58	S155016	60	S170012	52		
S123421	134	S136002	110	S137030	110	S150081	63	S152011	58	S155017	60	S170013	52		
S123422	134	S136003	110	S137031	110	S150082	59	S152012	58	S155018	59	S180001	136		
S123423	134	S136004	110	S137032	110	S150083	59	S152013	58	S156001	61	S180003	136		
S123424	134	S136005	110	S150001	57	S150084	59	S152014	58	S156002	61	S180021	136		
S123426	134	S136006	110	S150002	57	S150085	59	S152015	58	S156003	61	S180022	136		
S123427	134	S136007	110	S150003	58	S150086	59	S152016	58	S156004	61	S190001	136		
S123429	134	S136008	110	S150004	58	S150087	59	S152017	58	S156005	61	S190002	136		
S123430	134	S136009	110	S150005	61	S150088	59	S152018	58	S156006	61	S200010	128		
S123432	134	S136010	110	S150006	61	S150089	59	S152019	58	S156007	61	S200011	128		
S123433	134	S136011	110	S150007	61	S150090	59	S152021	58	S156008	61	S200020	128		
S123434	134	S136012	110	S150008	62	S150091	59	S152022	58	S156009	61	S200021	128		
S123436	134	S136013	110	S150009	62	S150092	58	S152024	58	S156010	61	S200030	128		
S123438	134	S136014	110	S150010	62	S150093	63	S152027	58	S156011	61	S200031	128		
S123441	134	S136015	110	S150011	63	S150094	63	S152030	58	S156012	61	S200040	128		
S123442	134	S136016	110	S150012	63	S150095	63	S152032	58	S156013	61	S200041	128		
S123446	134	S136017	110	S150013	63	S150096	63	S153006	59	S156014	61	S200050	128		
S123450	134	S136018	110	S150014	63	S150097	57	S153007	59	S156015	61	S200051	128		
S123455	134	S136019	110	S150015	63	S150098	57	S153008	59	S156016	59	S200060	128		
S123460	134	S136020	110	S150016	62	S150099	57	S153009	59	S156018	60	S200061	128		
S123465	134	S136021	110	S150017	62	S150100	57	S153010	59	S156019	60	S200070	128		
S123517	134	S136022	110	S150018	62	S151001	55	S153011	59	S156020	60	S200071	128		
S123518	134	S136023	110	S150019	60	S151002	55	S153012	59	S157001	60	S200080	128		
S123519	134	S136024	110	S150020	60	S151003	55	S153013	59	S157002	60	S200081	128		
S123522	134	S136025	110	S150021	60	S151004	55	S153014	59	S157003	60	S200110	128		
S123524	134	S136026	110	S150022	60	S151005	55	S153015	59	S157004	60	S200111	128		
S123527	134	S136027	110	S150023	60	S151006	55	S153016	59	S158001	60	S200120	128		
S123530	134	S136028	110	S150024	60	S151007	55	S153017	59	S158002	60	S200121	128		
S123532	134	S136029	110	S150025	60	S151008	55	S153018	59	S158003	60	S200130	128		
S123534	134	S136030	110	S150026	60	S151009	55	S153019	59	S158004	60	S200131	128		
S123536	134	S136031	110	S150027	60	S151011	55	S153021	59	S158005	60	S200140	128		
S123541	134	S136032	110	S150028	60	S151012	55	S153022	59	S158021	55	S200141	128		
S123546	134	S136033	110	S150029	60	S151013	55	S153024	59	S158022	54	S200150	128		
S123550	134	S136034	110	S150030	60	S151014	55	S153027	59	S158023	54	S200151	128		
S123555	134	S136035	110	S150031	60	S151015	55	S153030	59	S158024	55	S200160	128		
S125001	132	S136036	110	S150032	60	S151016	55	S153032	59	S160001	65	S200161	128		
S125002	132	S136037	110	S150033	60	S151021	56	S154008	58	S160002	65	S200170	128		
S125003	132	S137001	110	S150034	60	S151022	56	S154010	58	S160003	65	S200171	128		
S125004	132	S137002	110	S150035	60	S151023	56	S154012	58	S160004	65	S200180	128		
S133001	109	S137003	110	S150036	60	S151024	56	S154024	60	S160005	65	S200181	128		
S133002	109	S137004	110	S150037	60	S151025	56	S154026	60	S160006	65	W1117	138		
S133011	111	S137005	110	S150038	60	S151026	56	S154027	60	S160007	65	W1119	138		
S133012	111	S137006	110	S150039	60	S151027	56	S154028	60	S160008	65	W1120	139		
S133013	111	S137007	110	S150040	60	S151028	56	S154029	60	S160009	65	W1125	139		
S133021	111	S137008	110	S150041	60	S151029	56	S154030	60	S160011	127	W1139	140		
S133022	111	S137009	110	S150042	60	S151030	56	S154031	60	S160012	127	W1150	140		
S133023	112	S137010	110	S150043	60	S151031	56	S154032	60	S160013	127	W1157	141		
S134001	109	S137011	110	S150044	62	S151032	56	S154033	60	S160014	127	W1210	142		
S134002	109	S137012	110	S150045	62	S151041	56	S154034	60	S160015	127	W1214	142		